

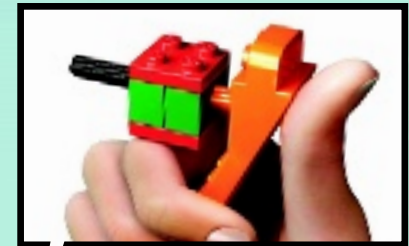

ULTRA AGENTS

70170





LEGO.com/brickseparator

IMPORTANT: Never modify the elements or use other projectiles than provided with this toy.
IMPORTANT : Ne jamais modifier les éléments ni utiliser d'autres projectiles que ceux fournis avec ce jouet.
2 IMPORTANTE: No modifique los elementos ni utilice otros proyectiles diferentes a los suministrados junto con este juguete.

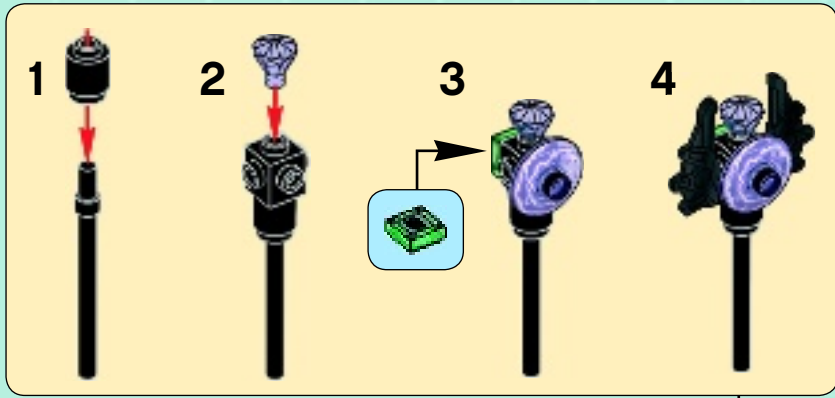
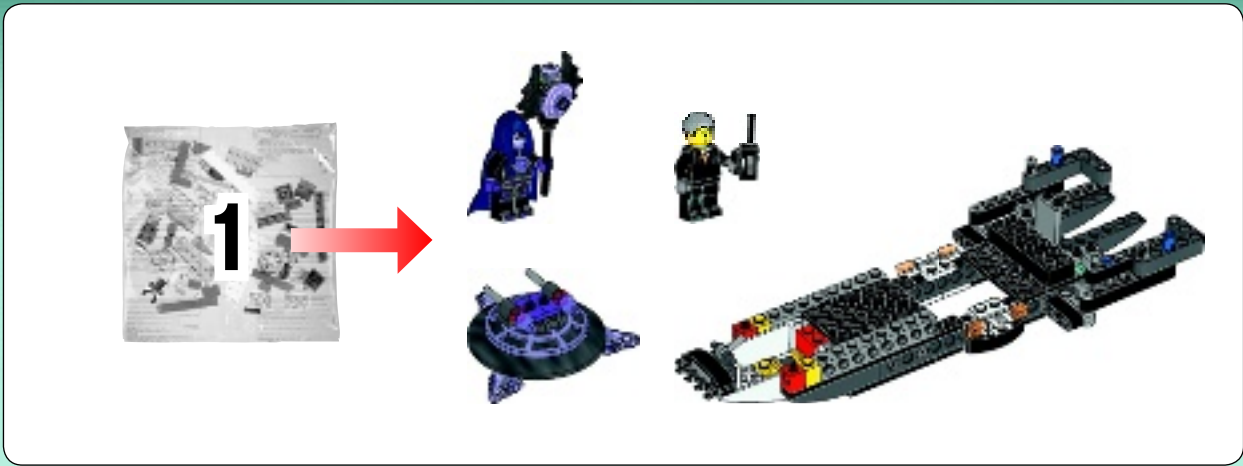



1

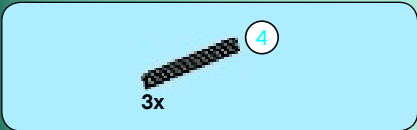

2

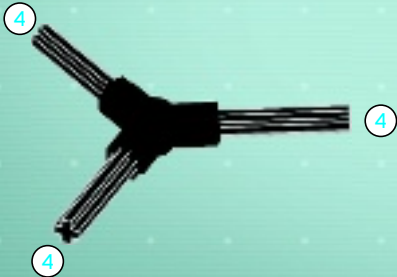

3

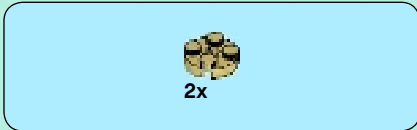
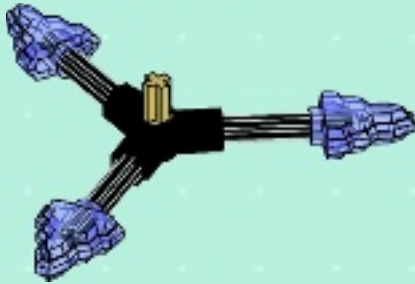

4

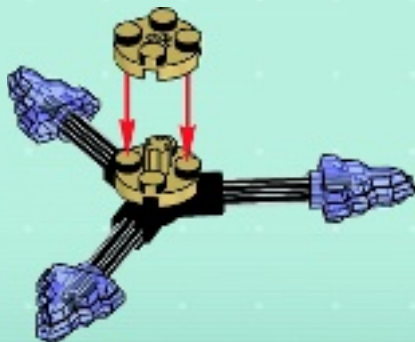



5

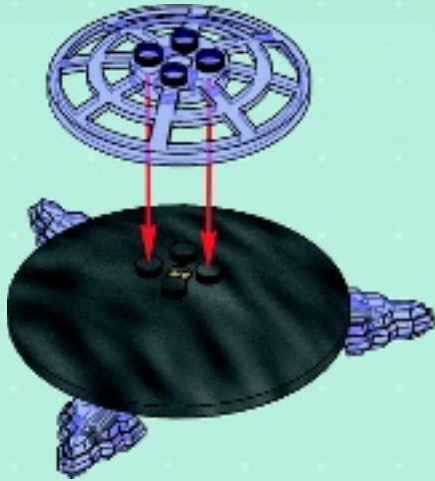

6



7



8





2x



2x



2x

9

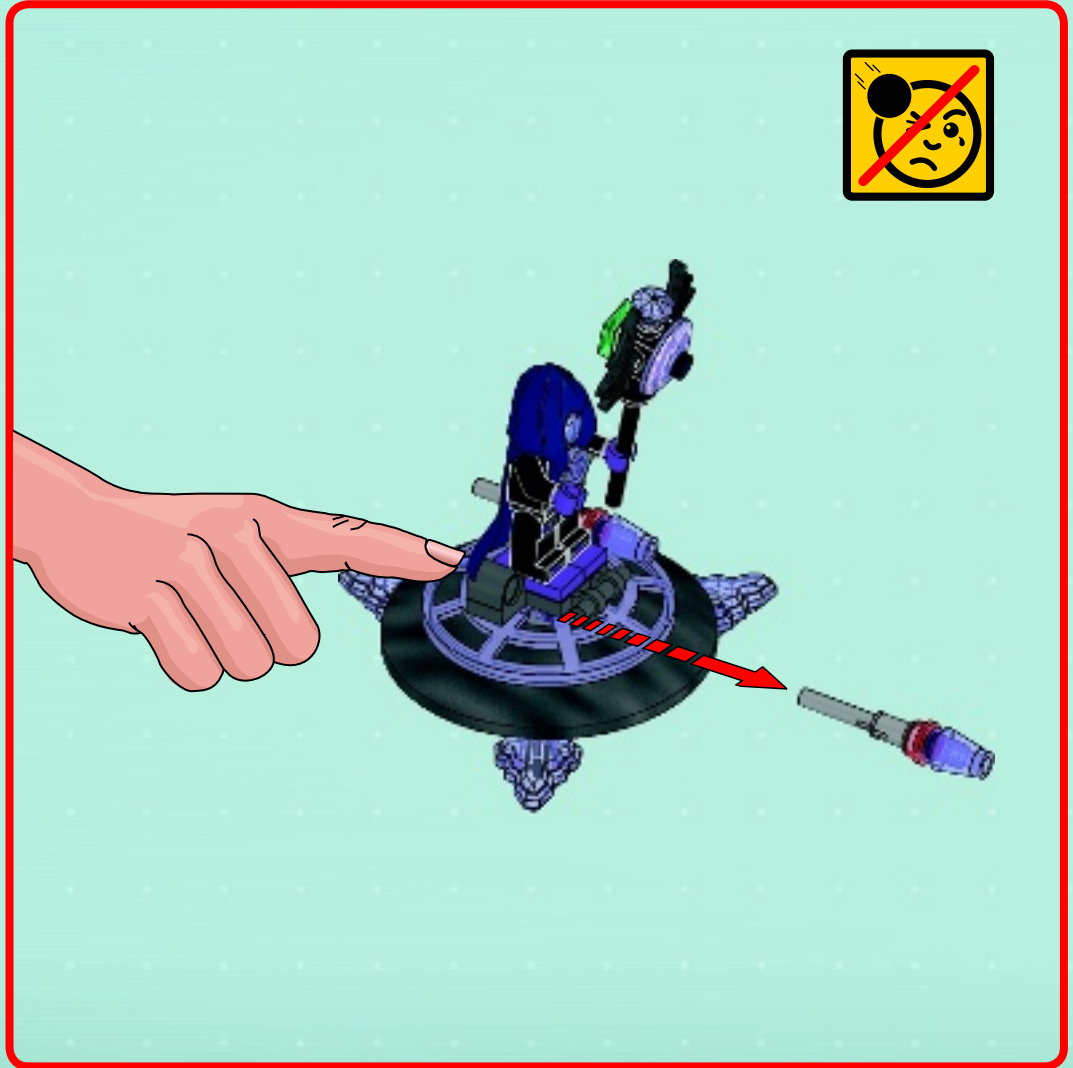
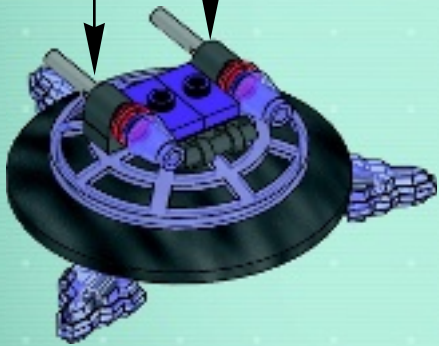
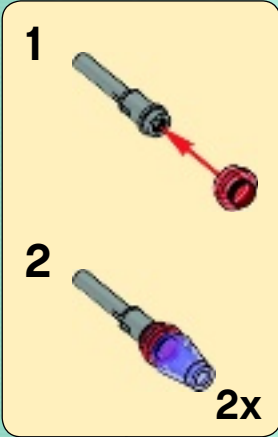

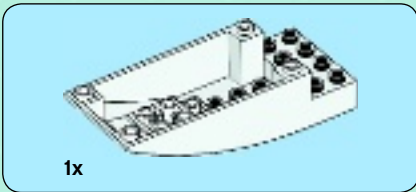

1

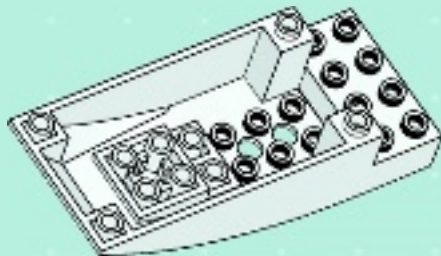

2

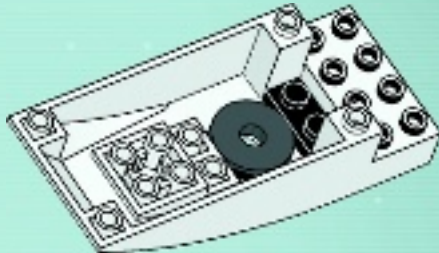

3

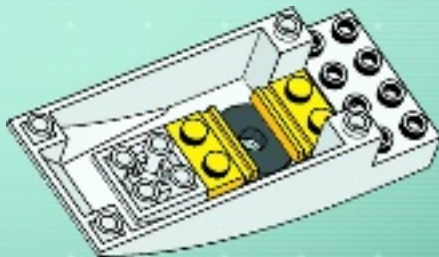

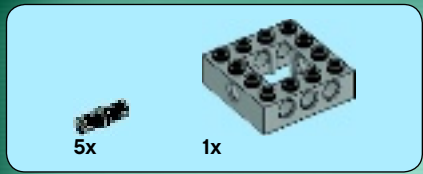

4

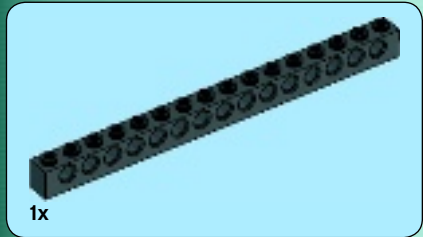
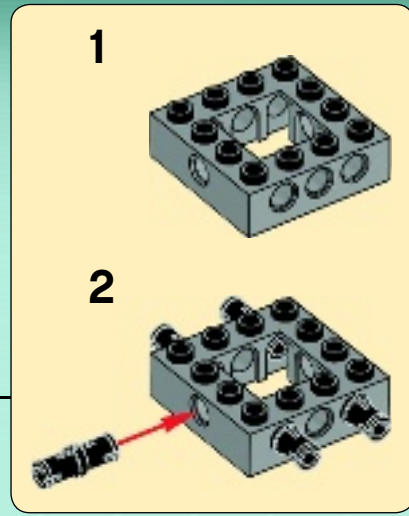
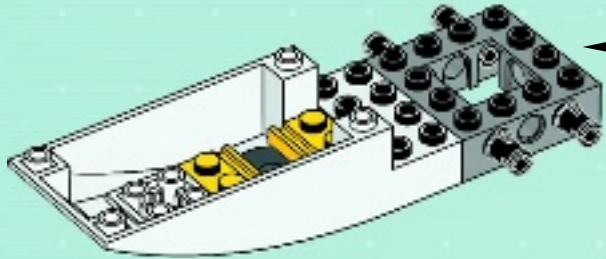

5

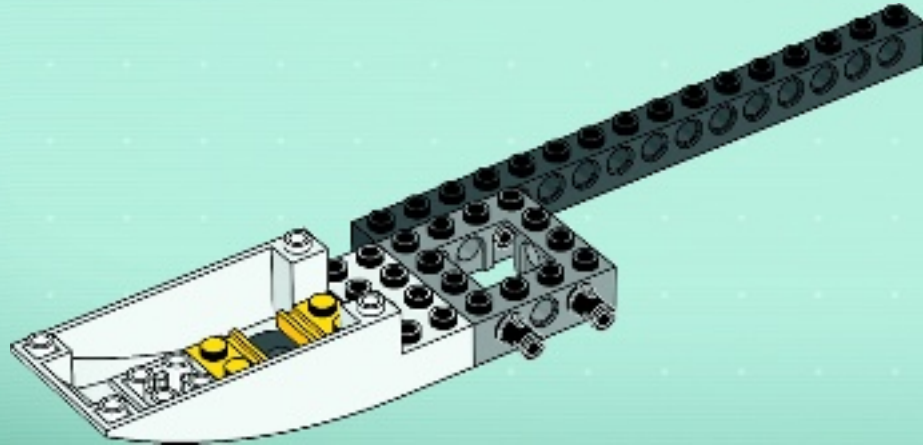

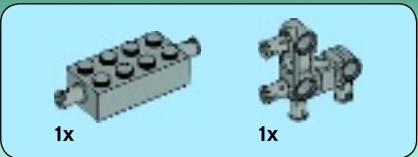

6

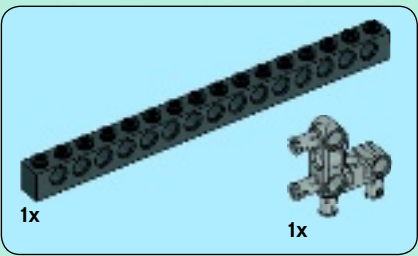
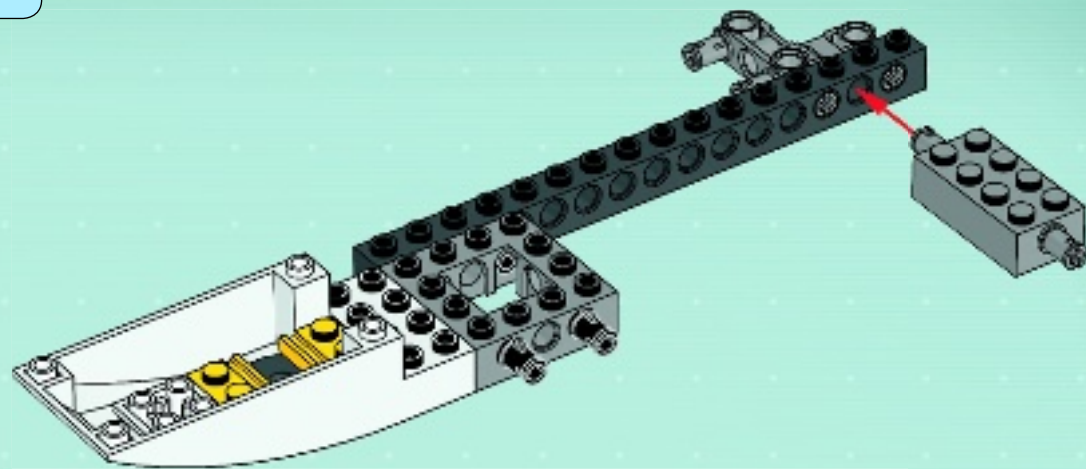

7

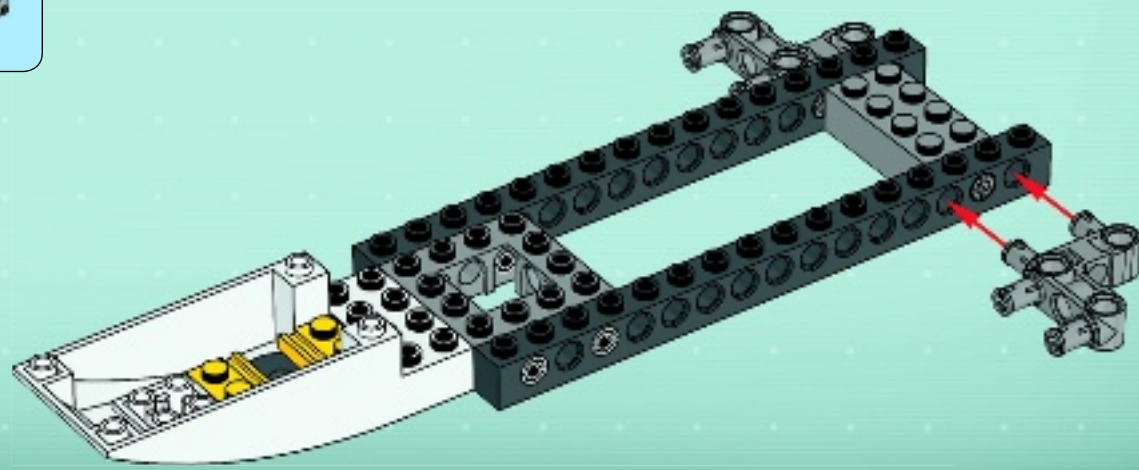



8

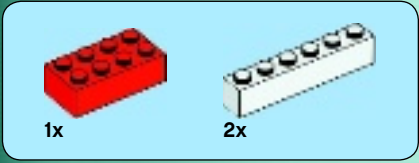
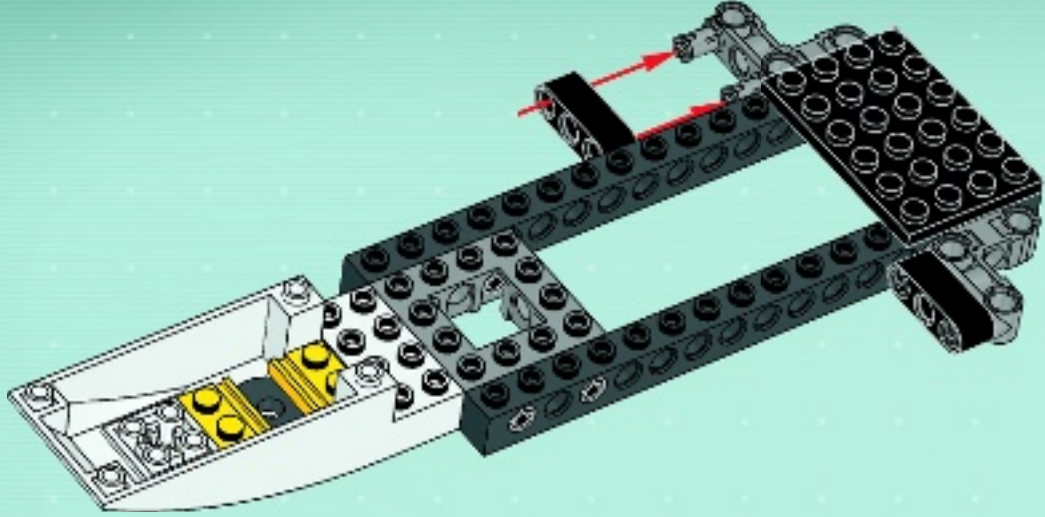

9

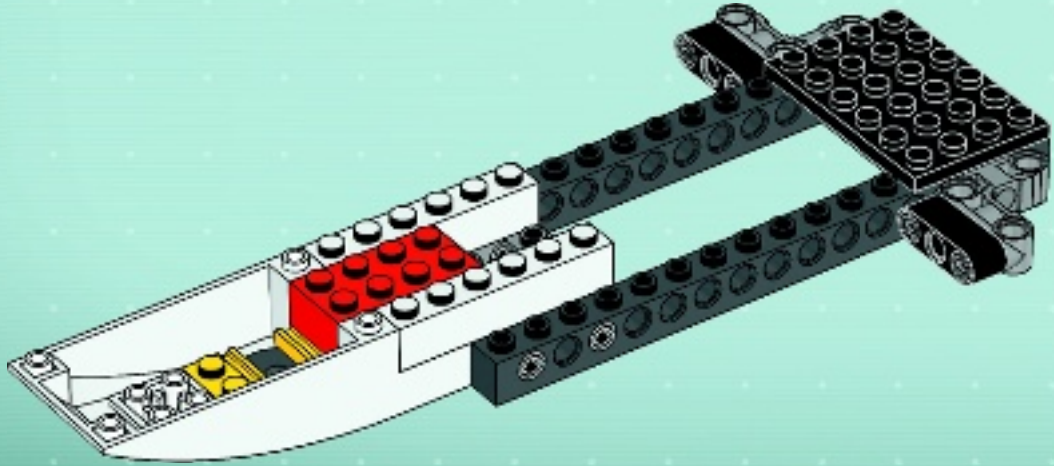



10

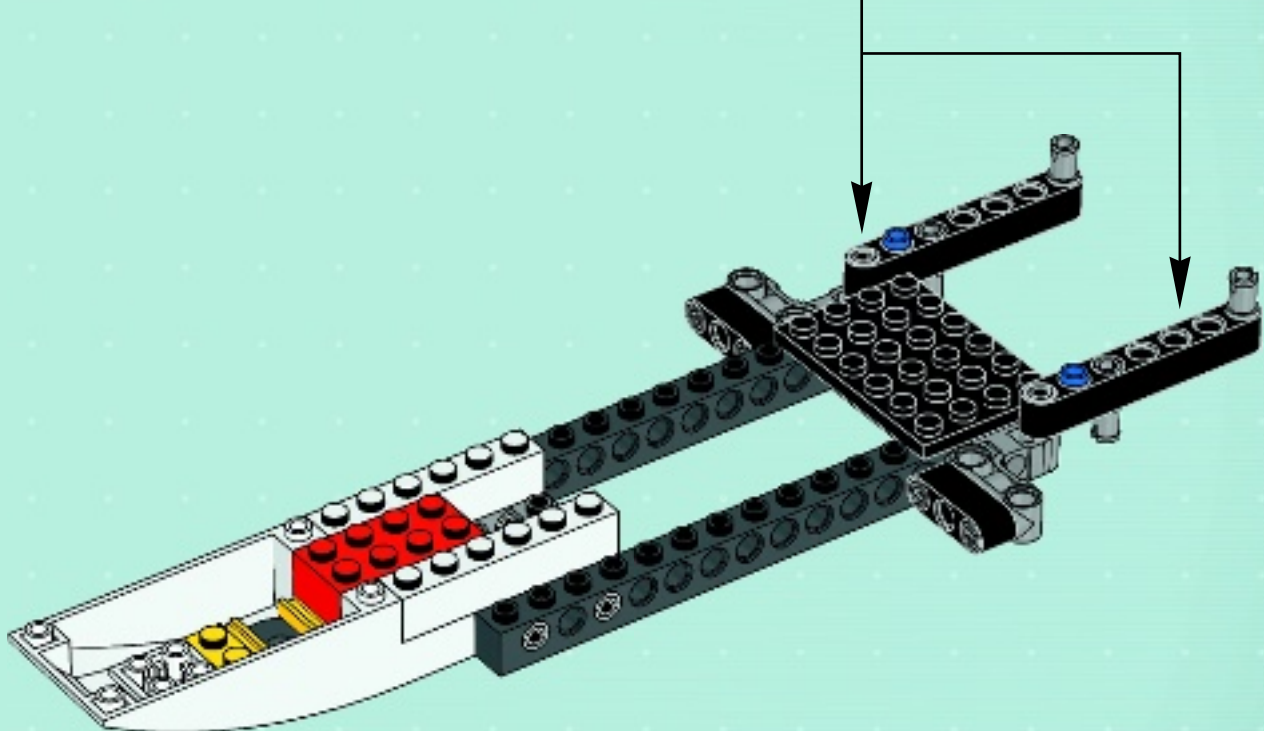
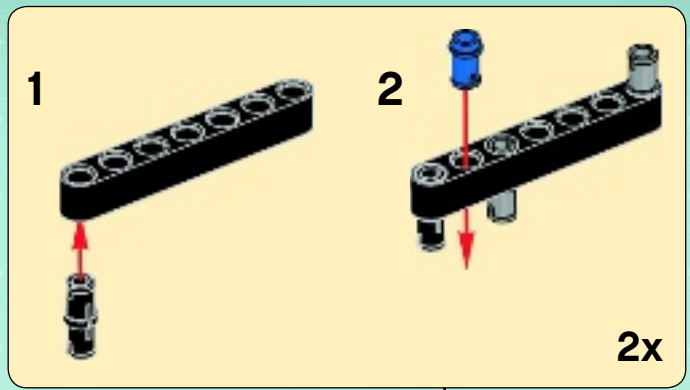

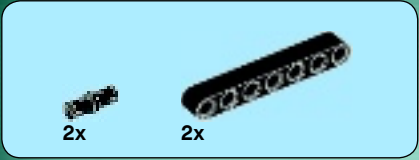

11

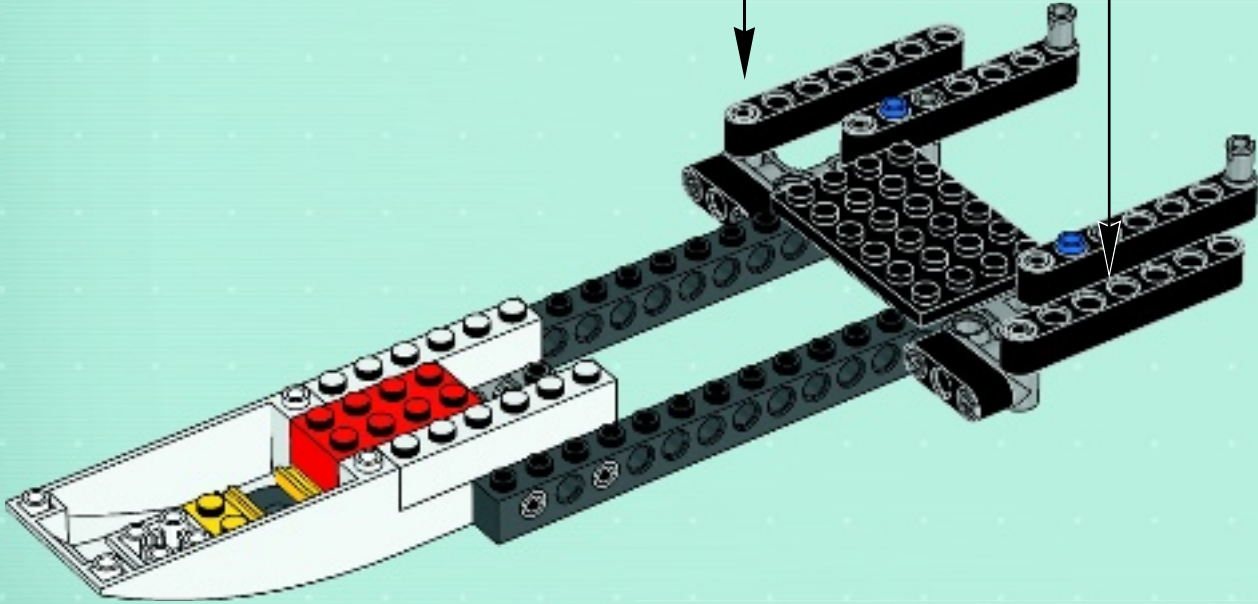
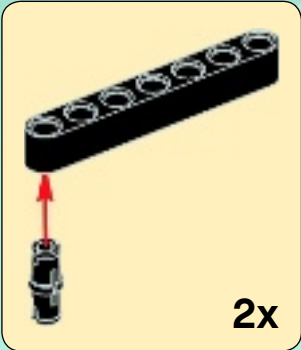



12

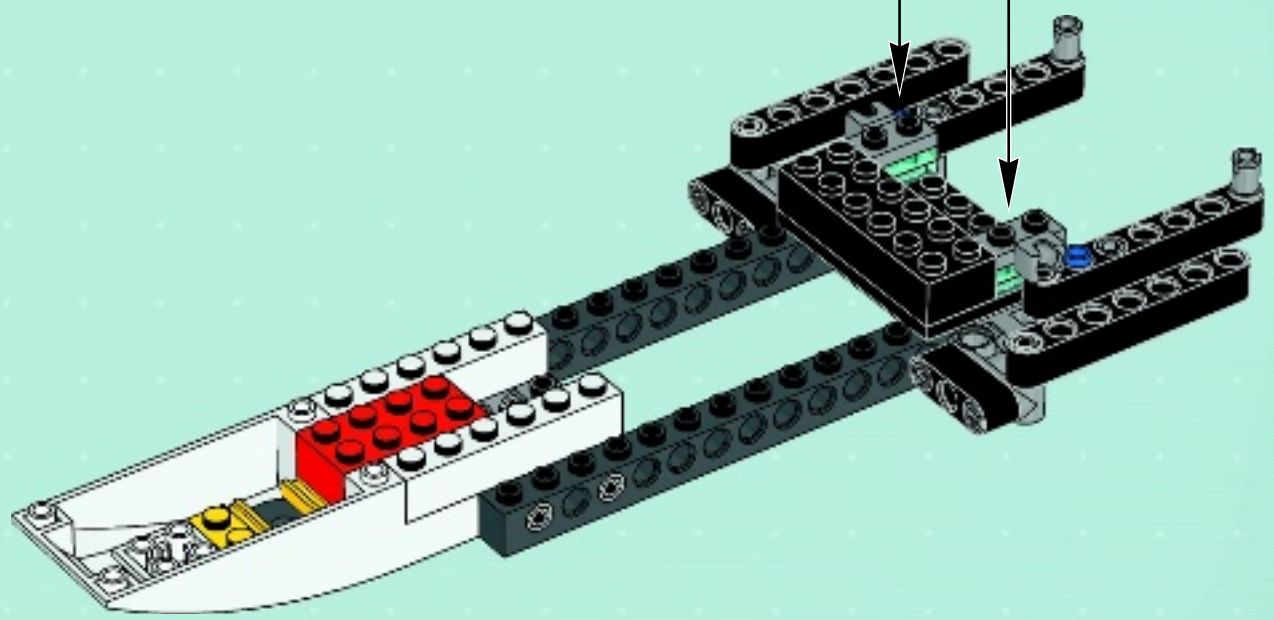
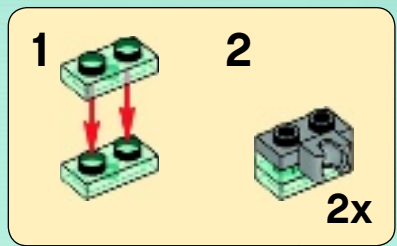

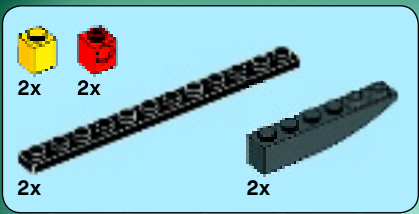

13

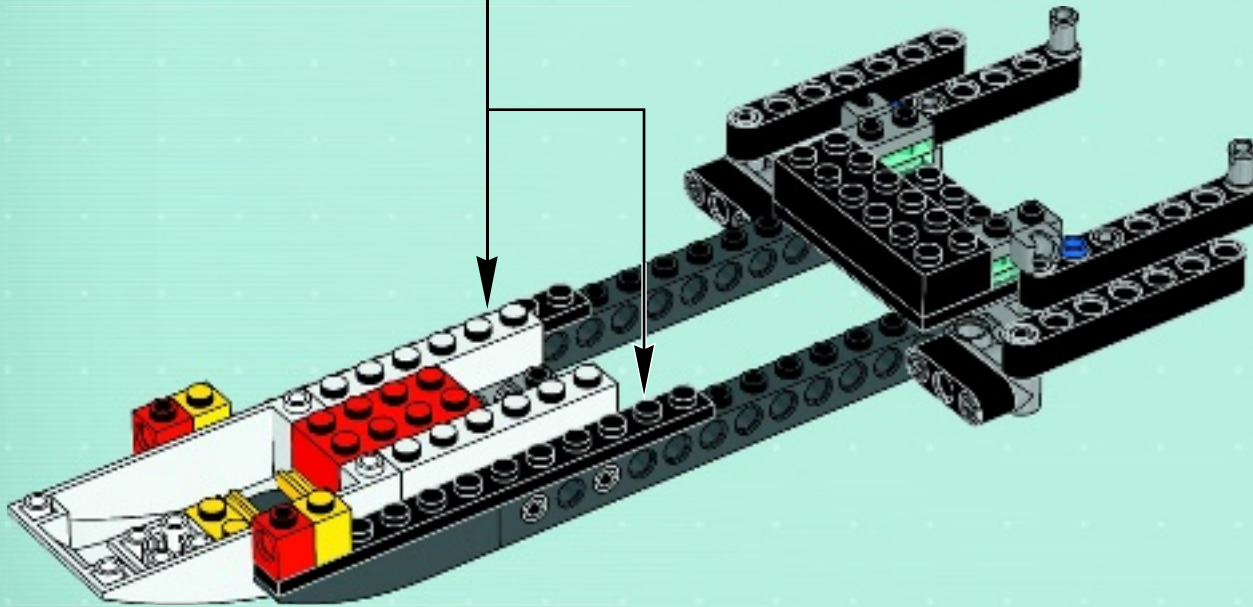
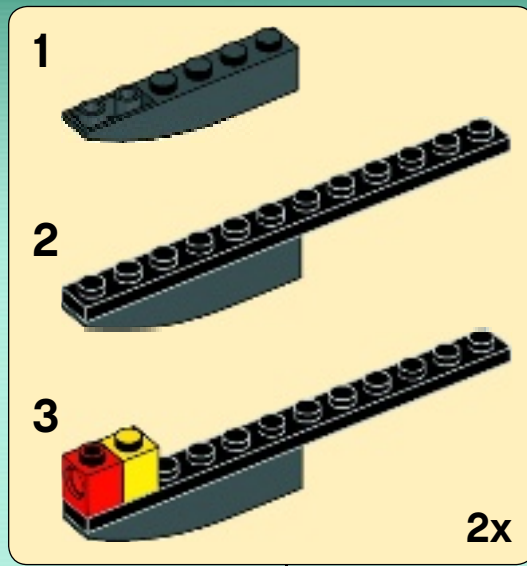

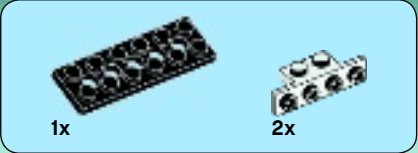

14

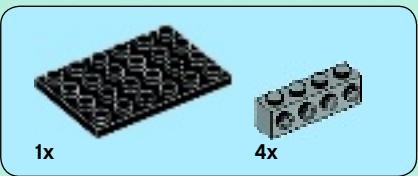
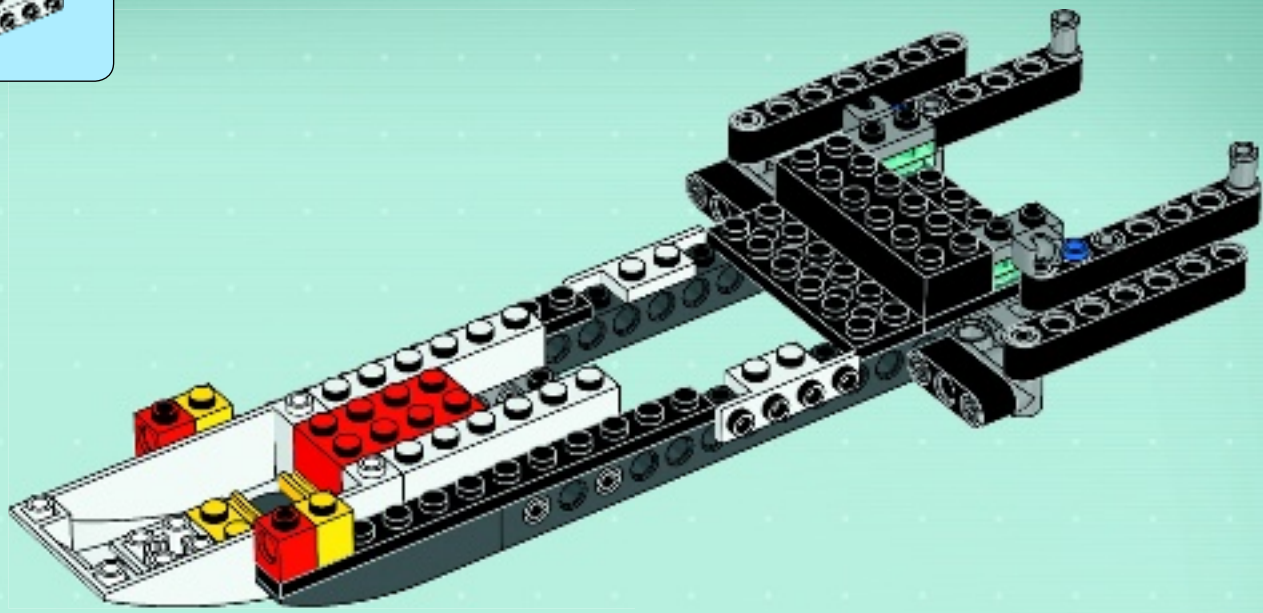

15

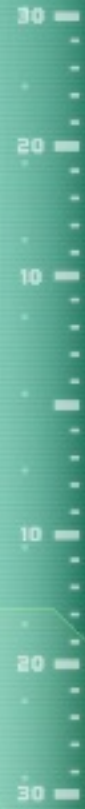
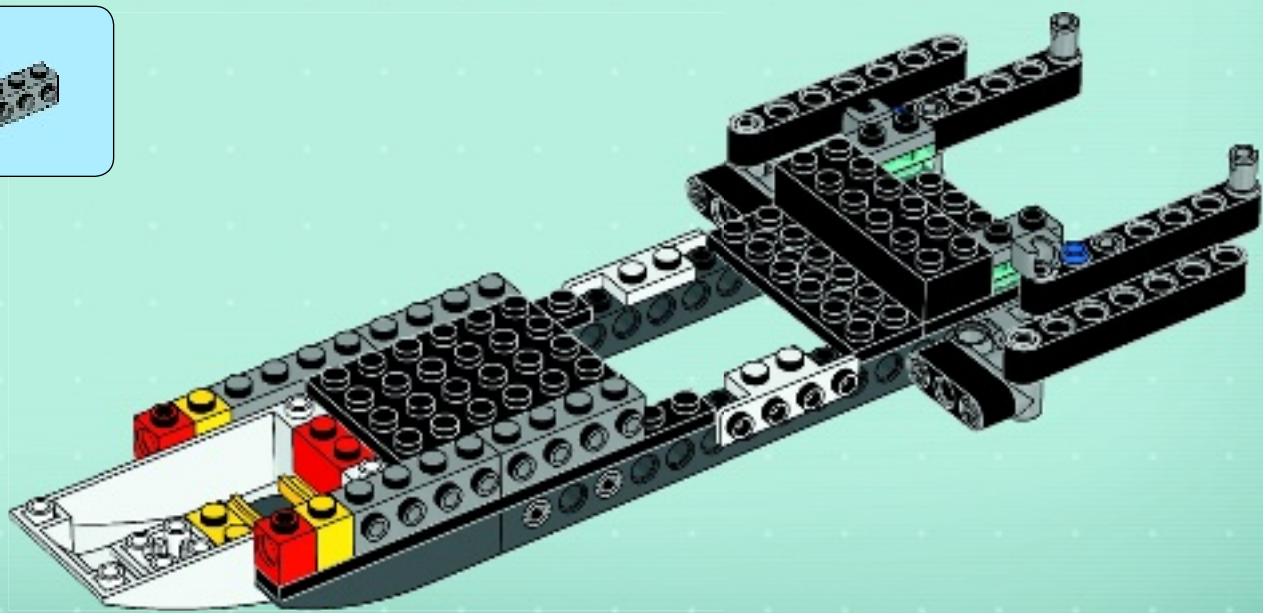

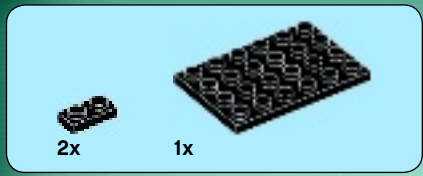

16

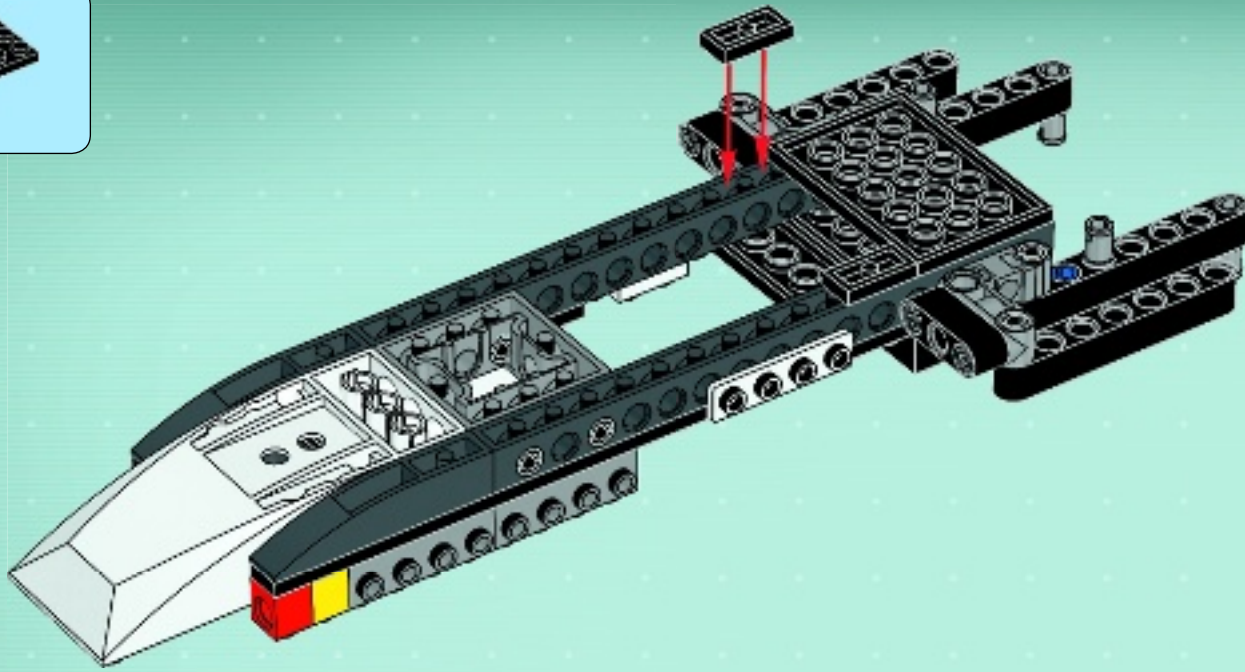

17

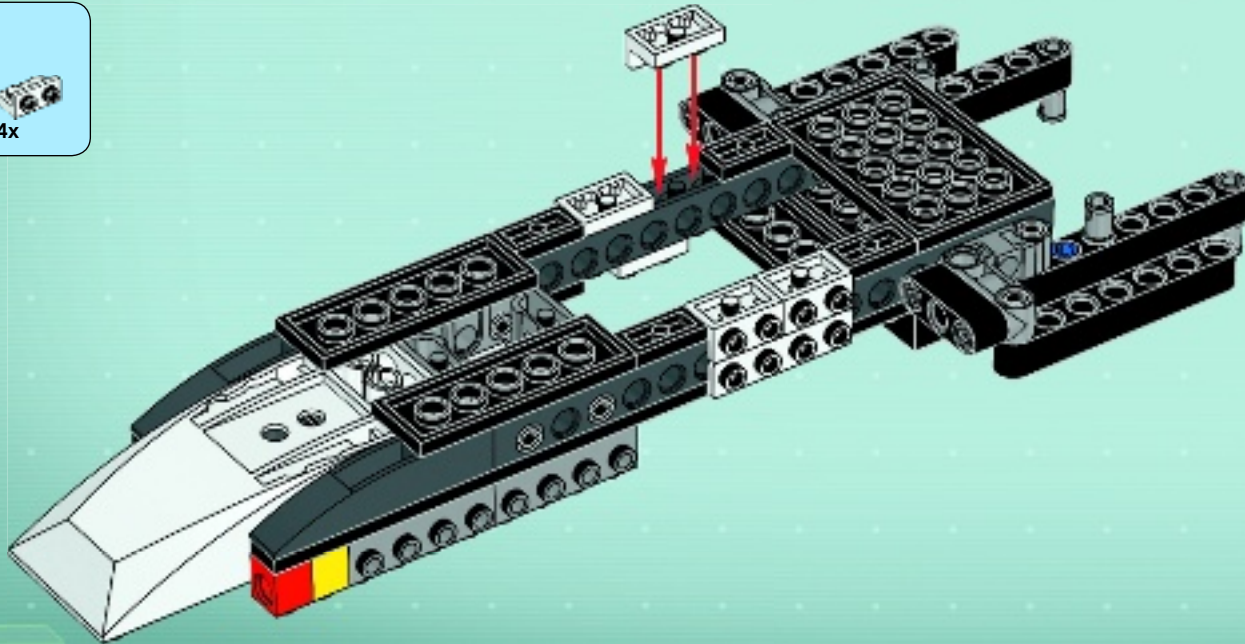

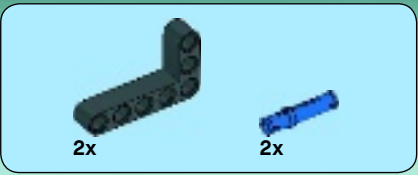

18

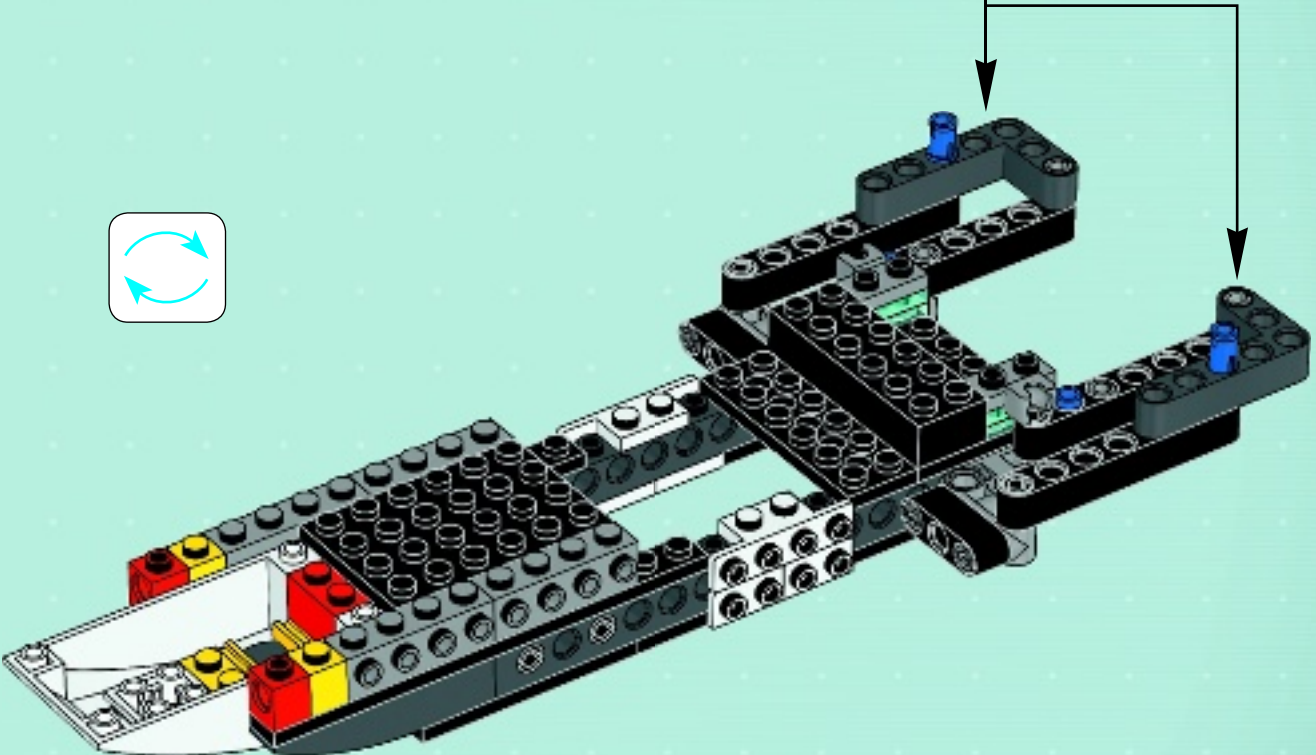
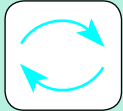
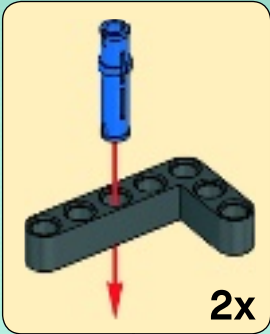

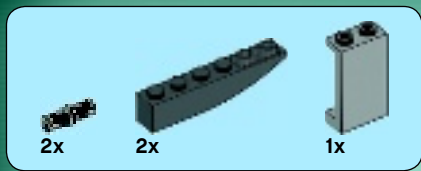

19

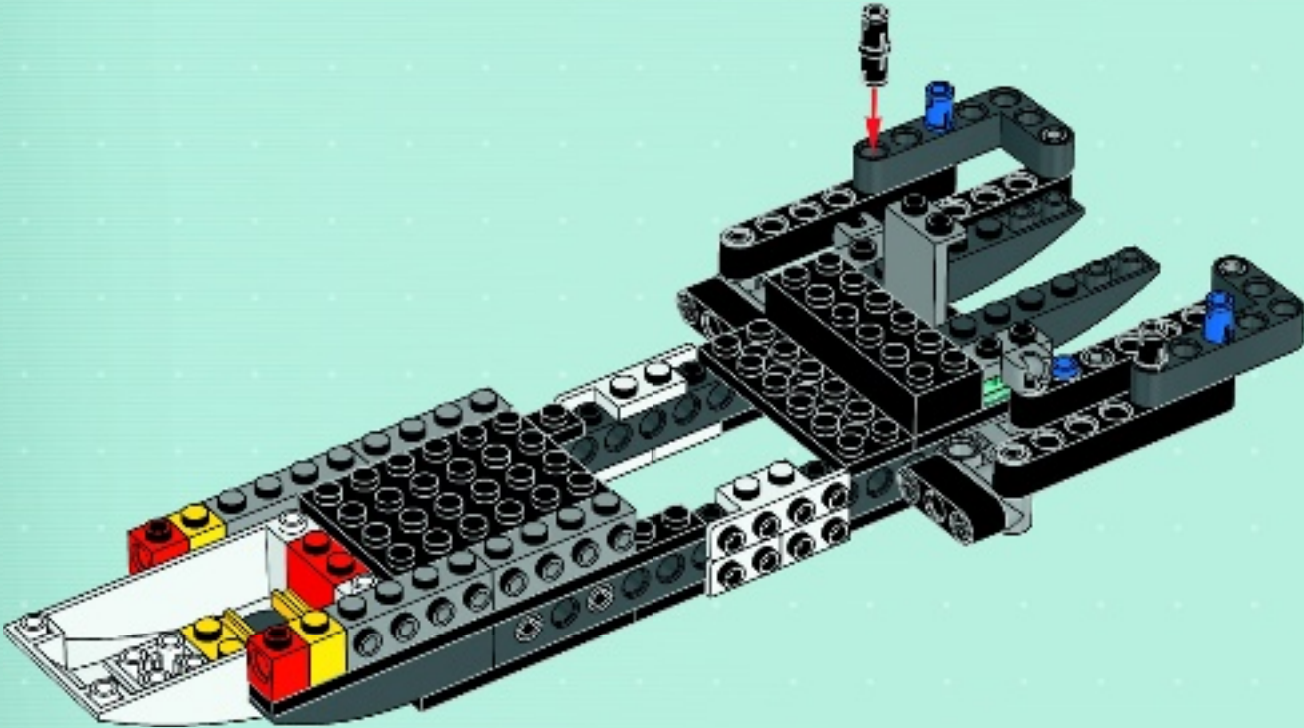

4x 4x 2x

20

1 2 2x

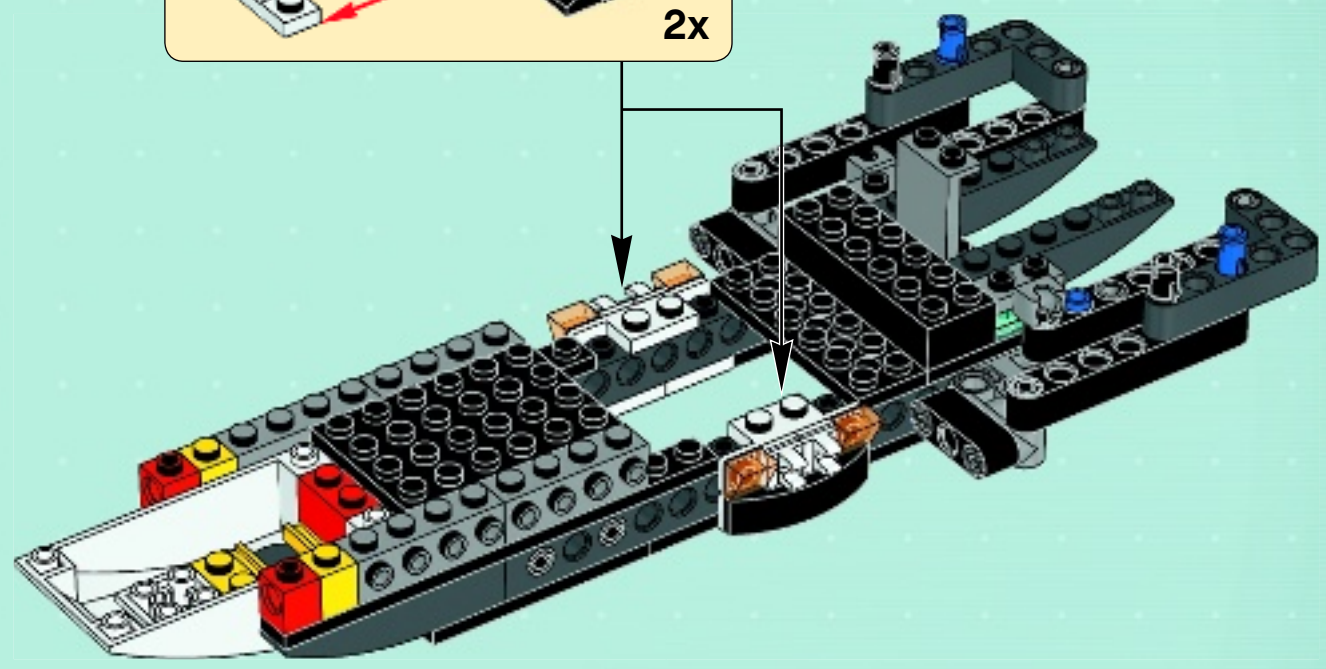



21

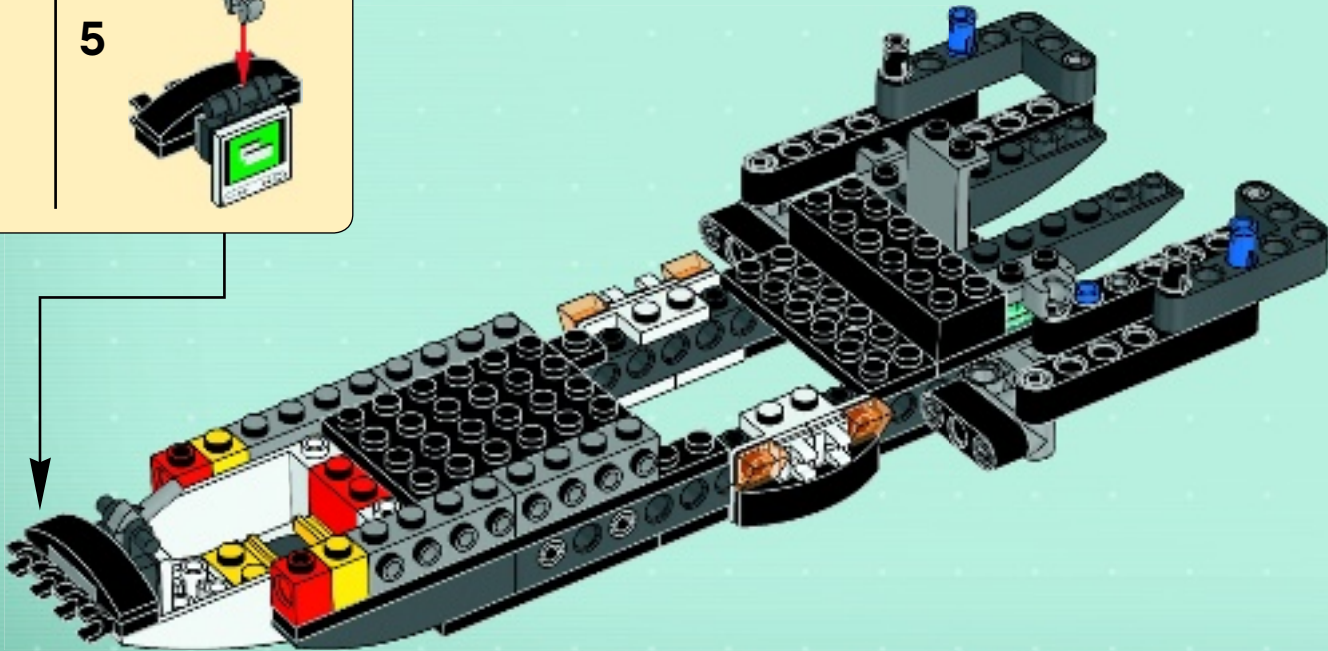
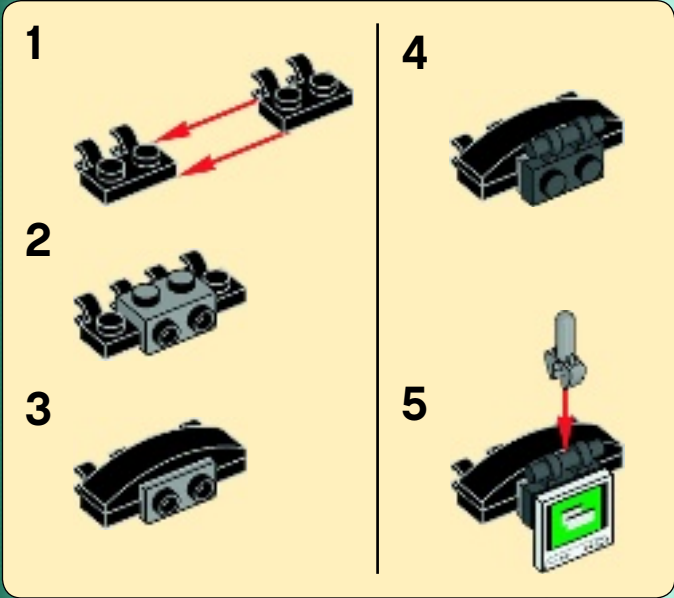

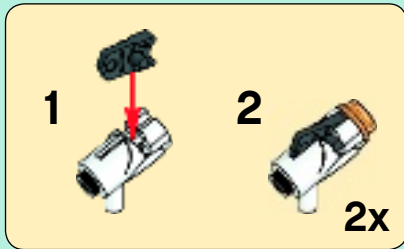
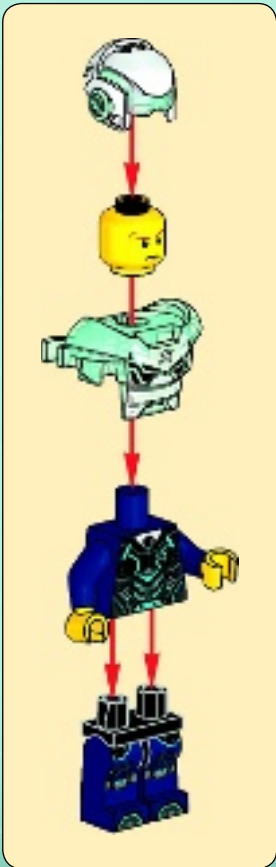
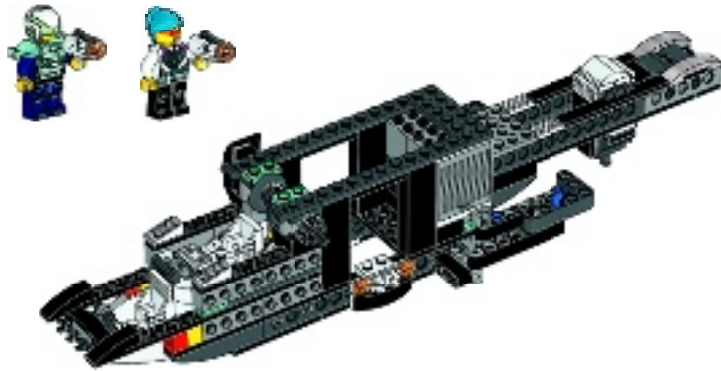



1

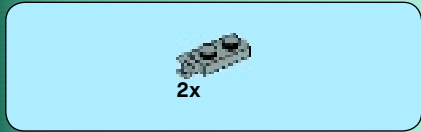

2

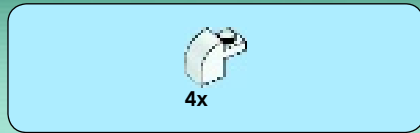

3

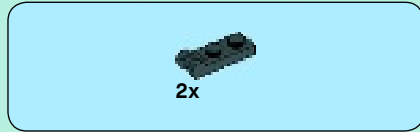
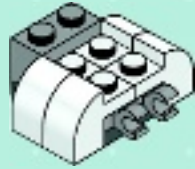

4



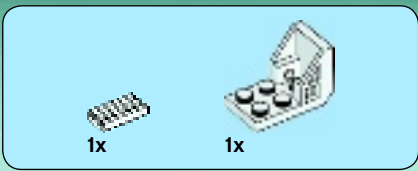

5

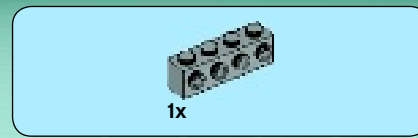

6

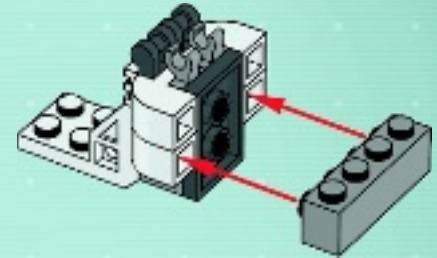
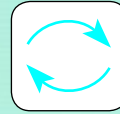

22

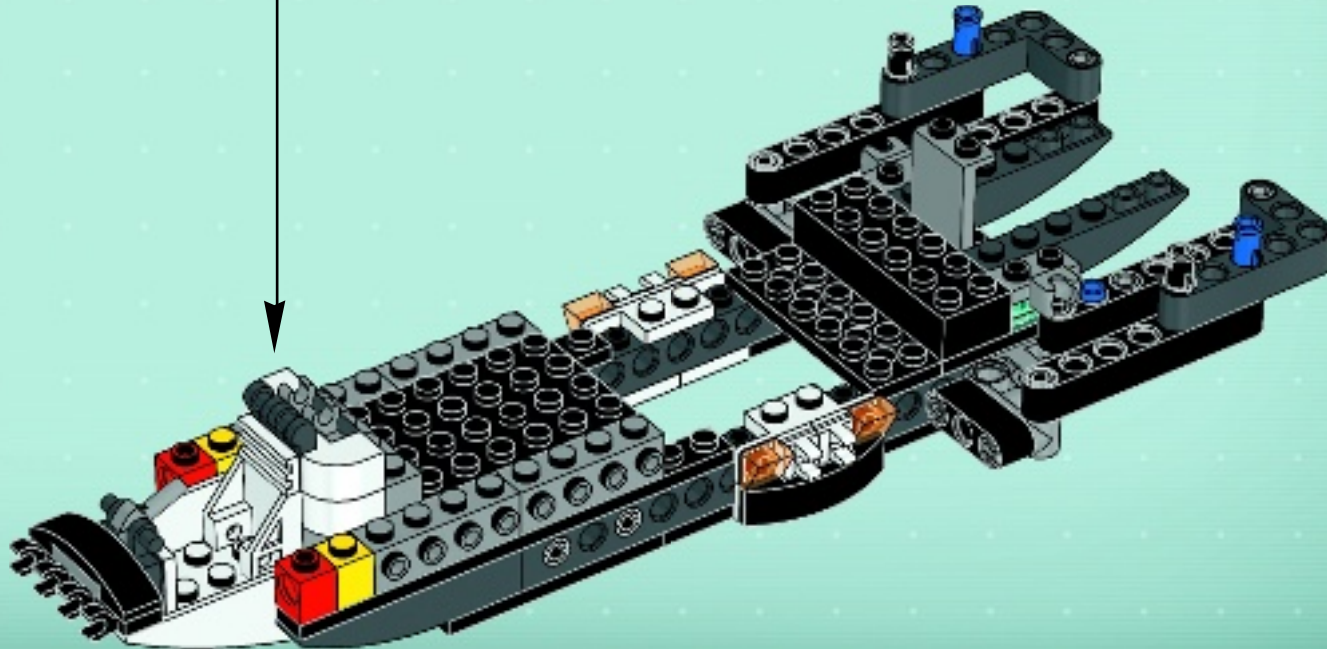

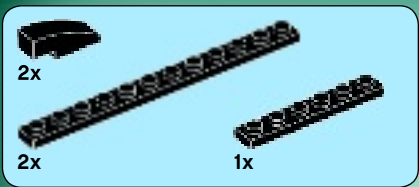

23

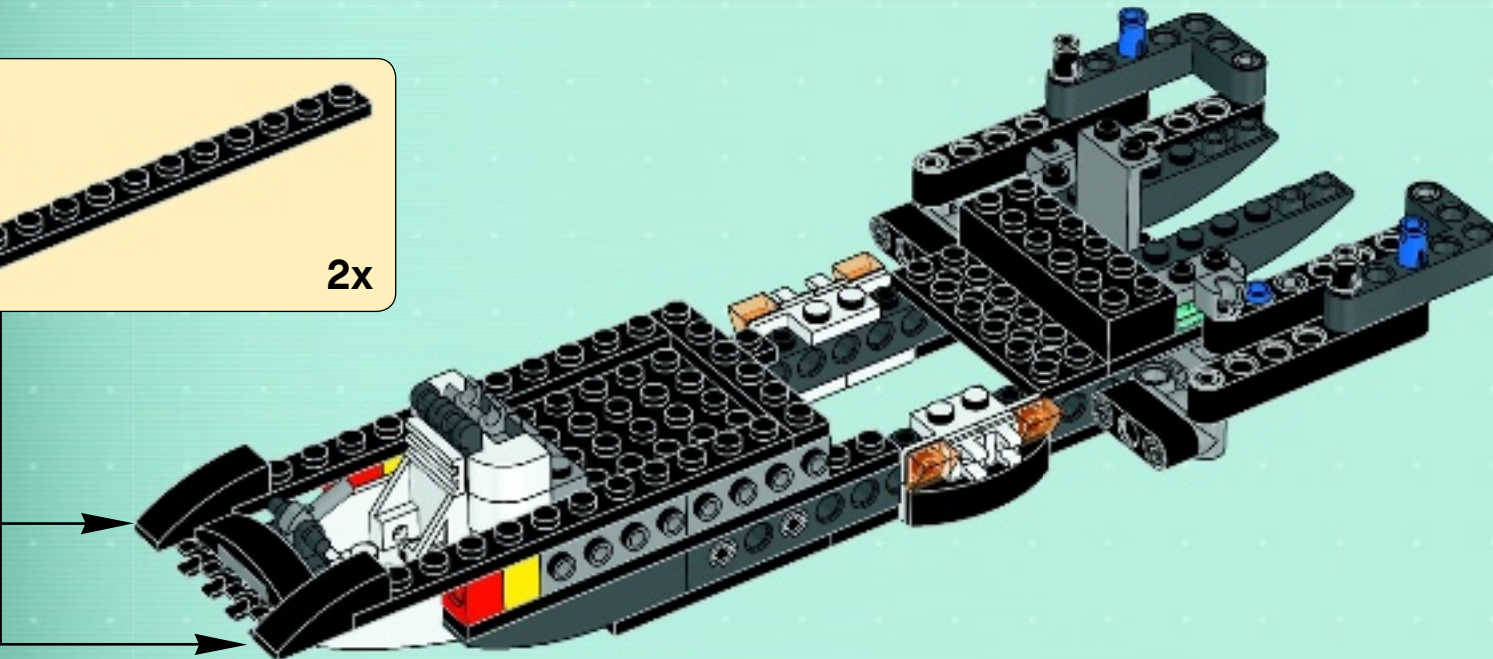
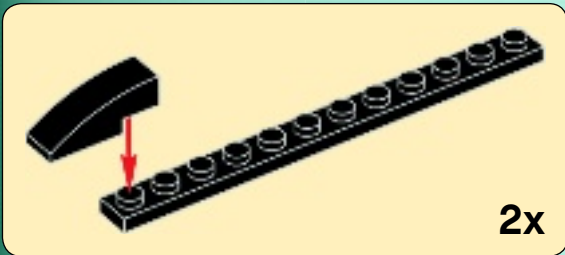



24

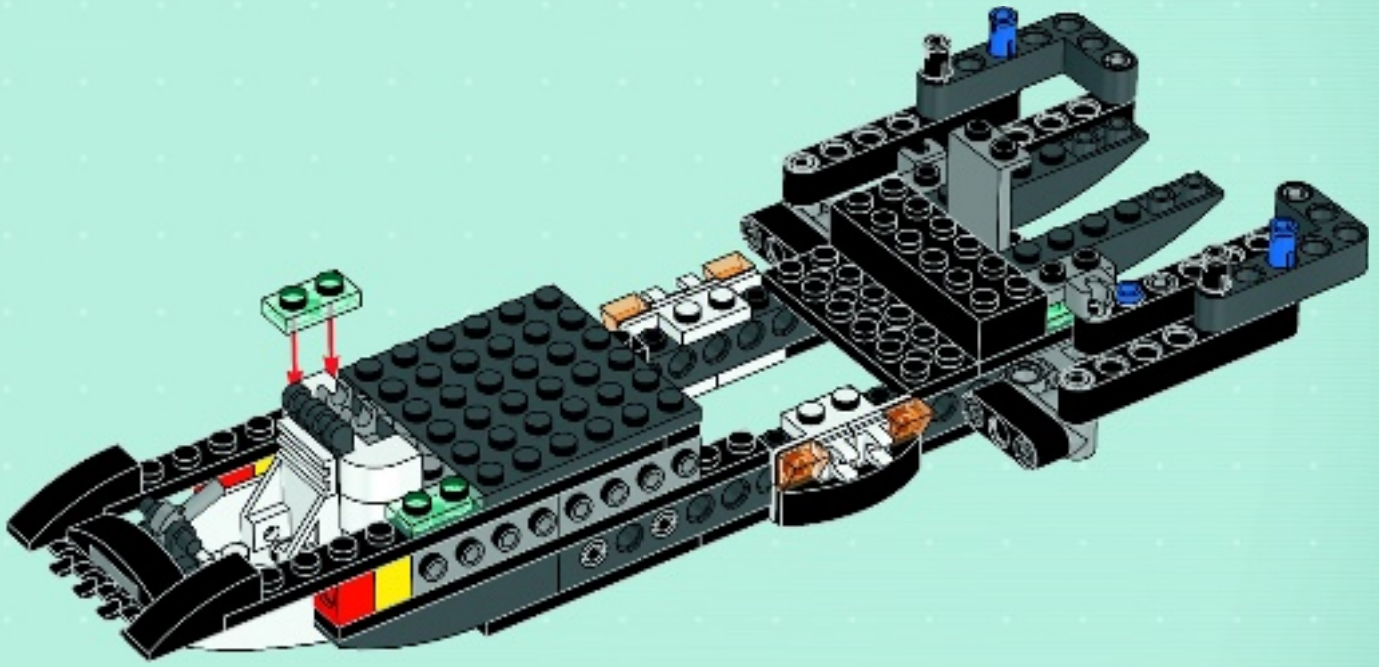



1x



2x



1x

25



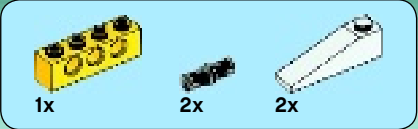

26

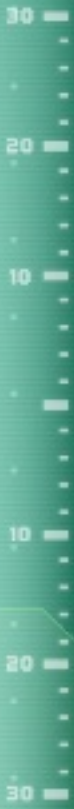
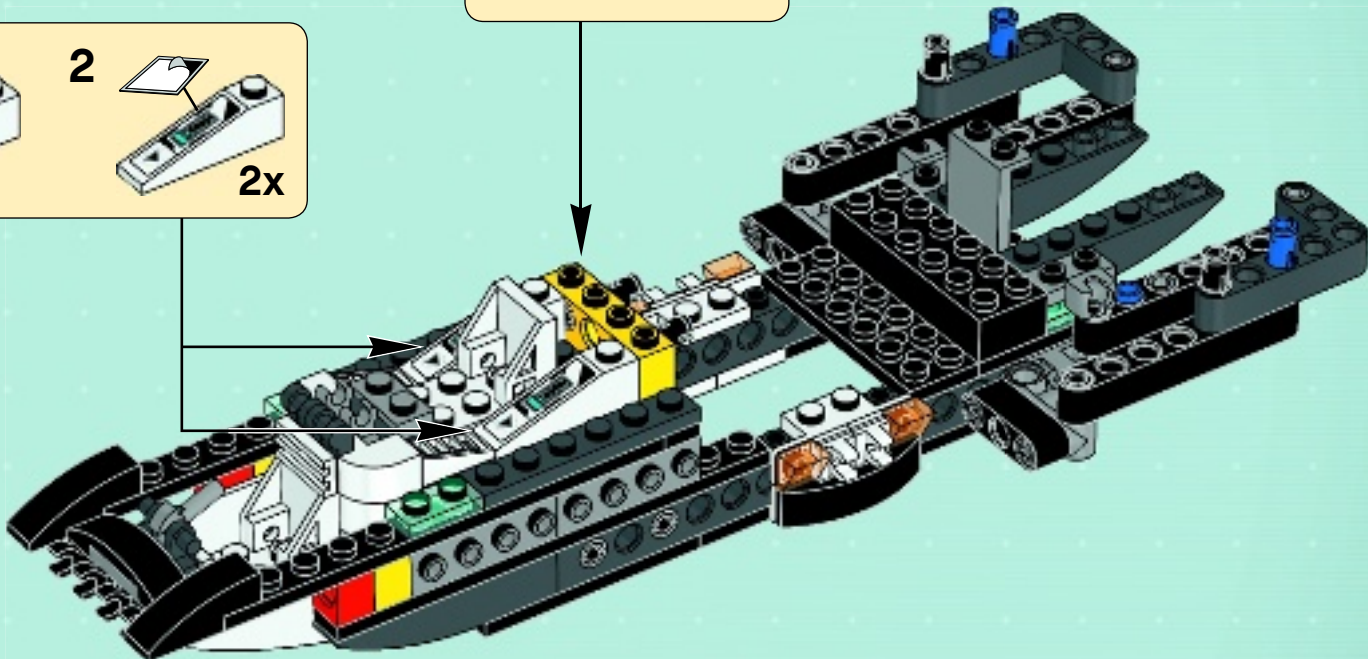
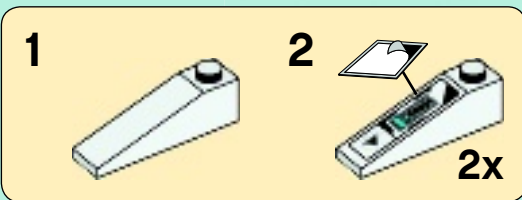
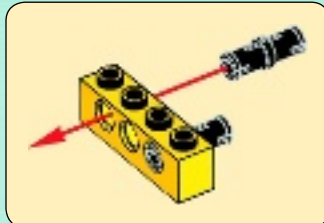



4x

27

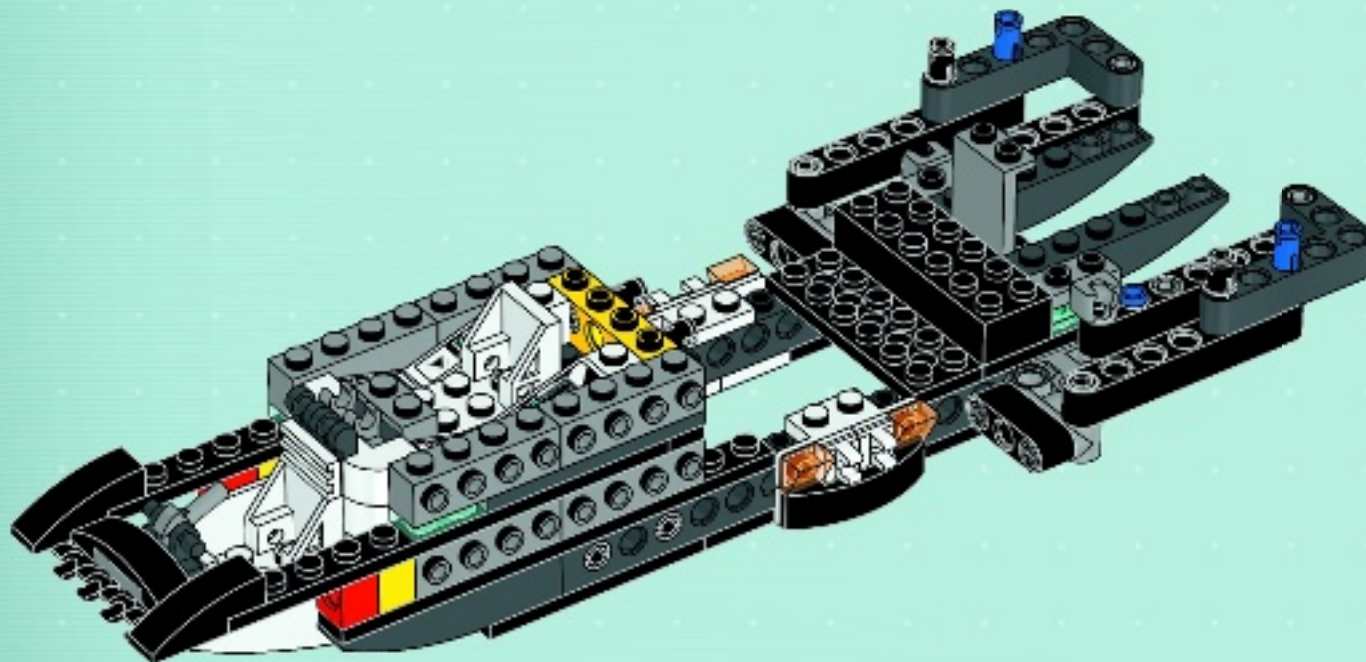

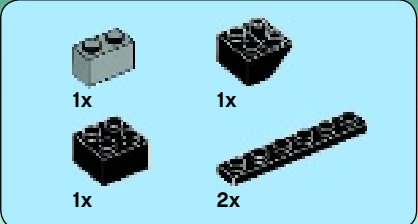

28

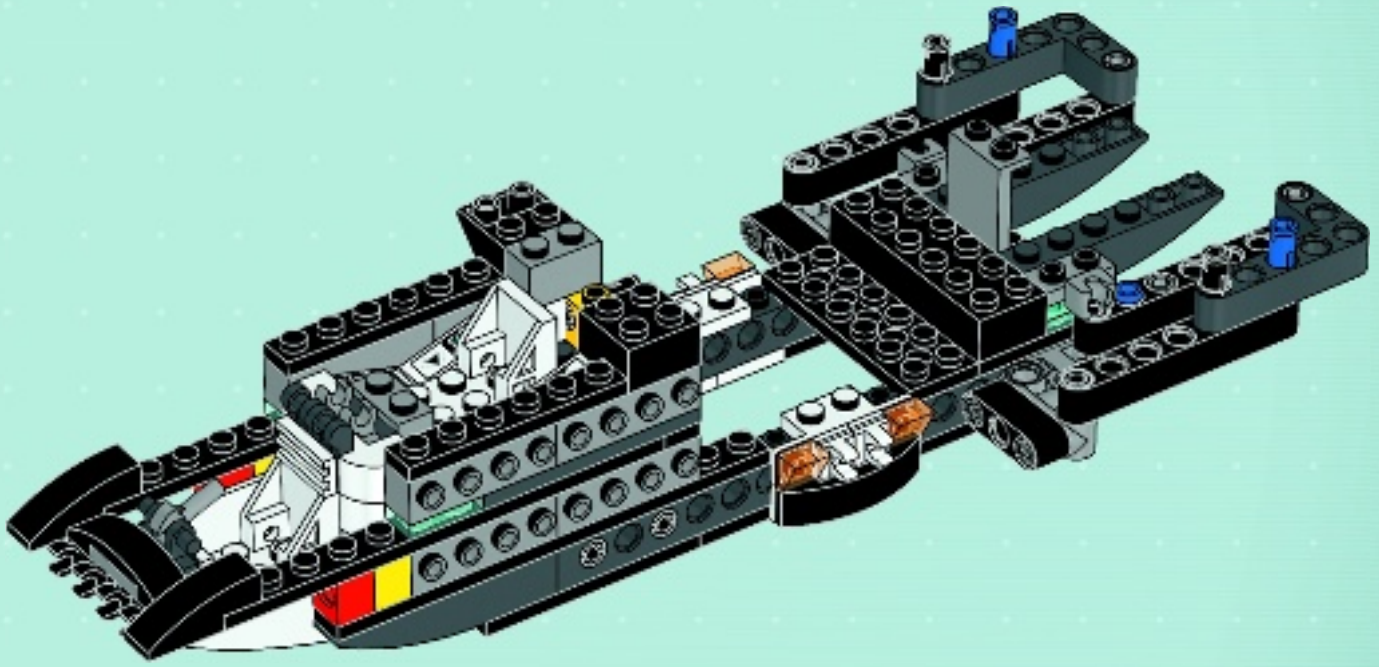



1x



2x

29

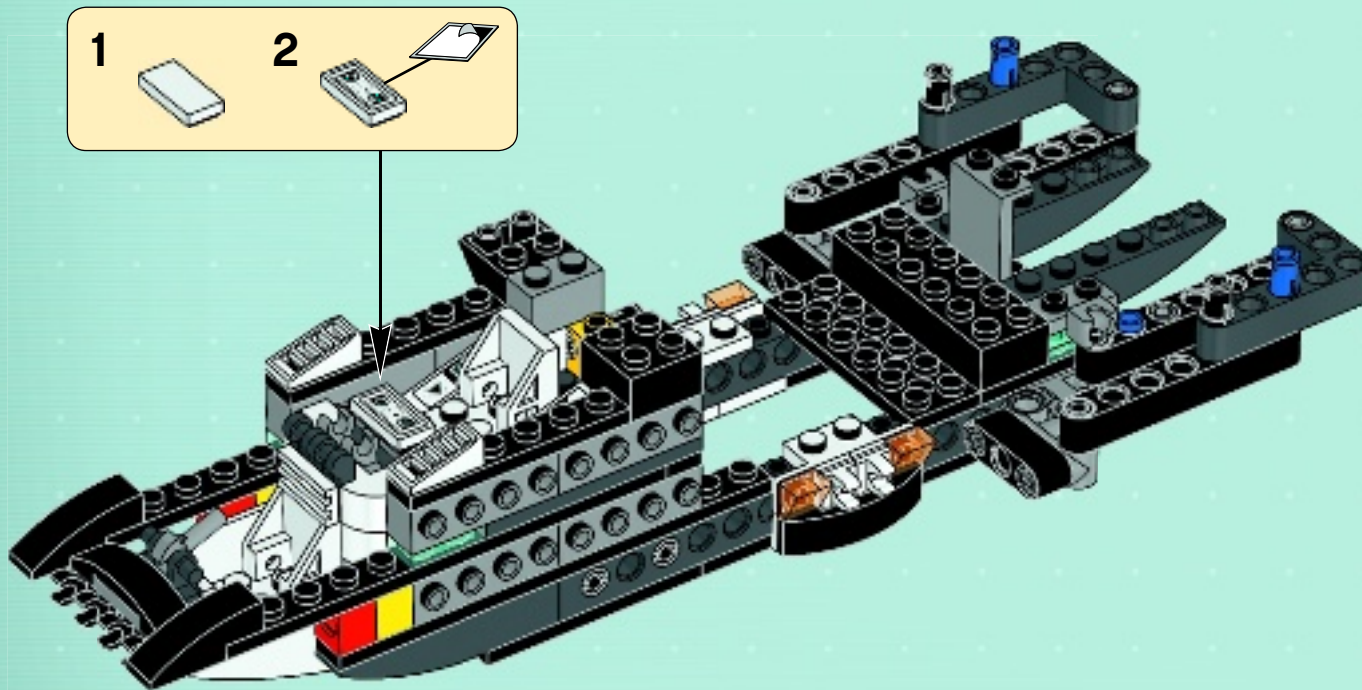

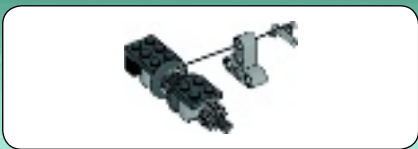

1



2

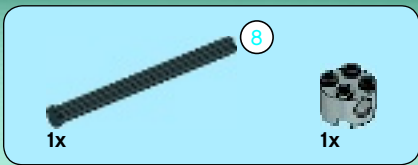

3

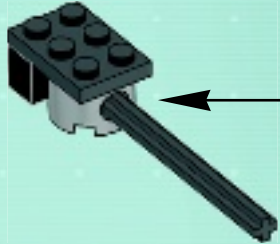
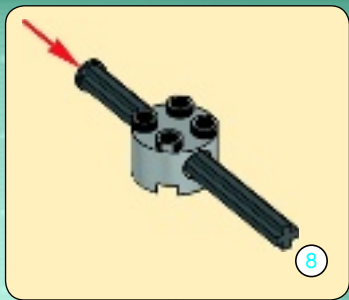

4

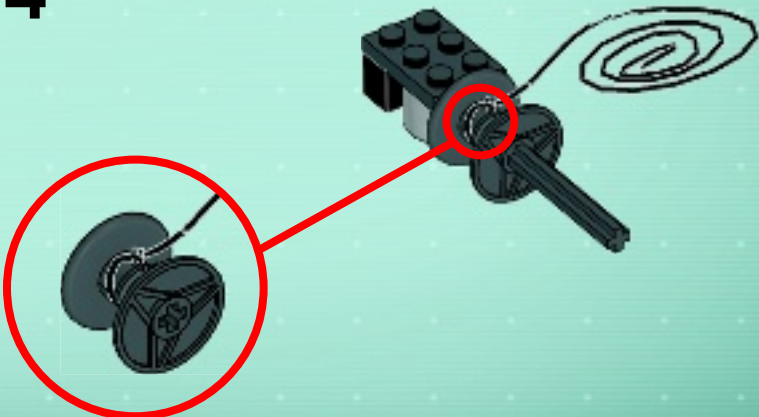



1x

5



1x



1x

6



1x



1x

7

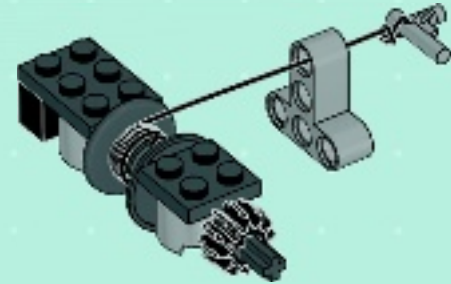

30

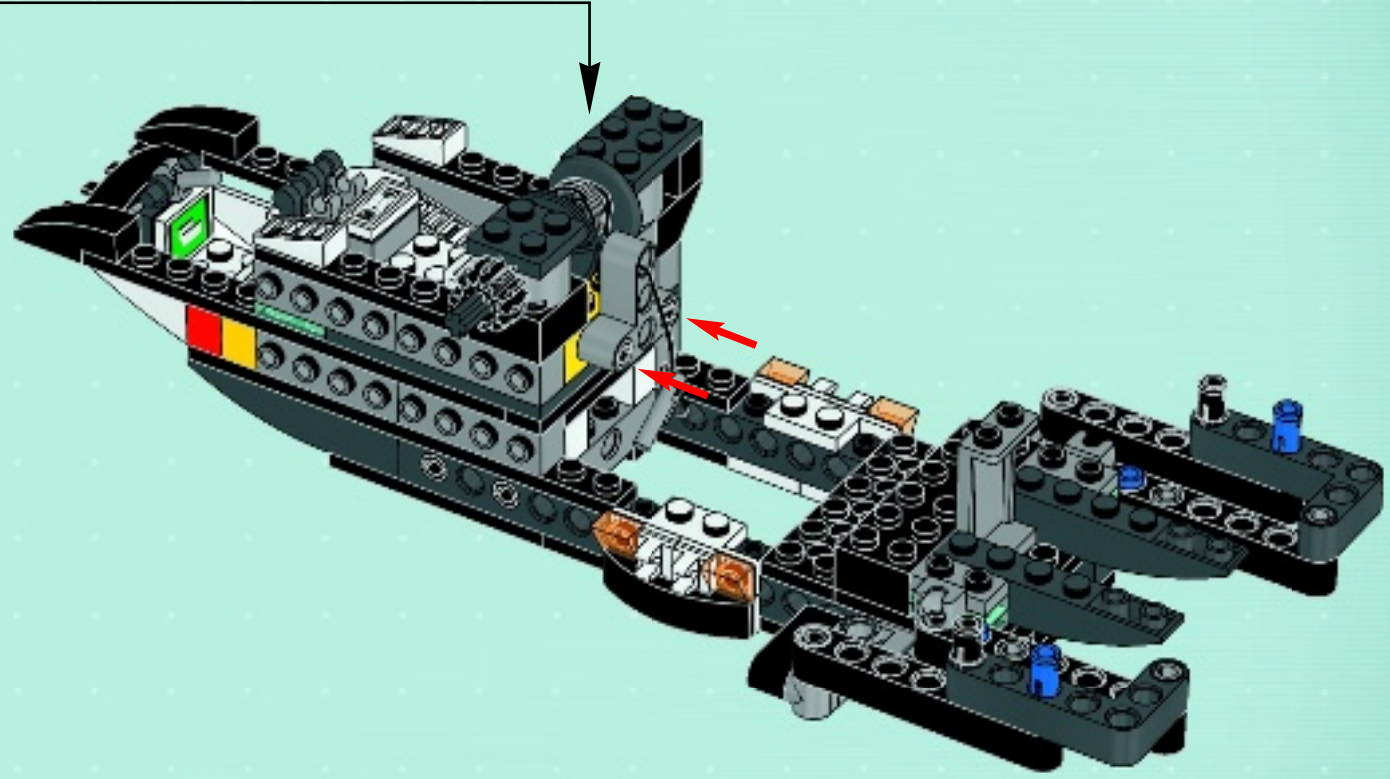
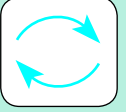



1x



2x



2x

31

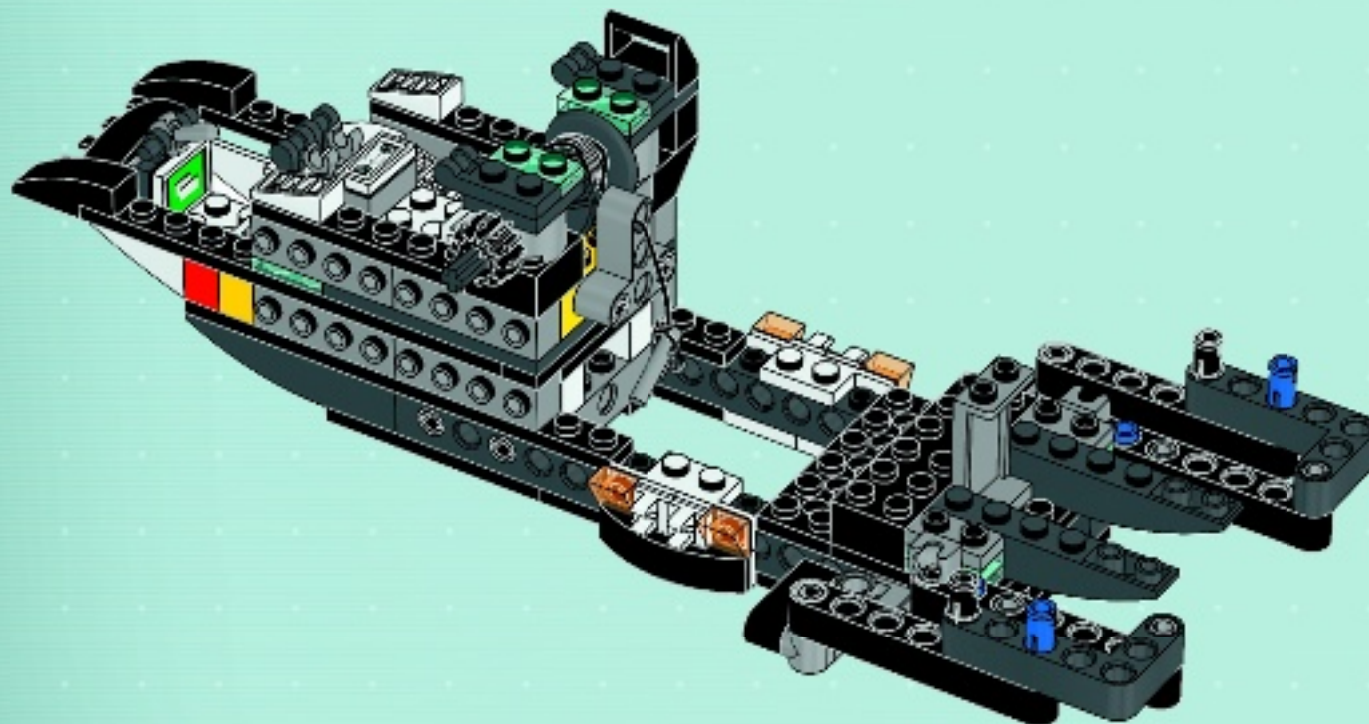



32

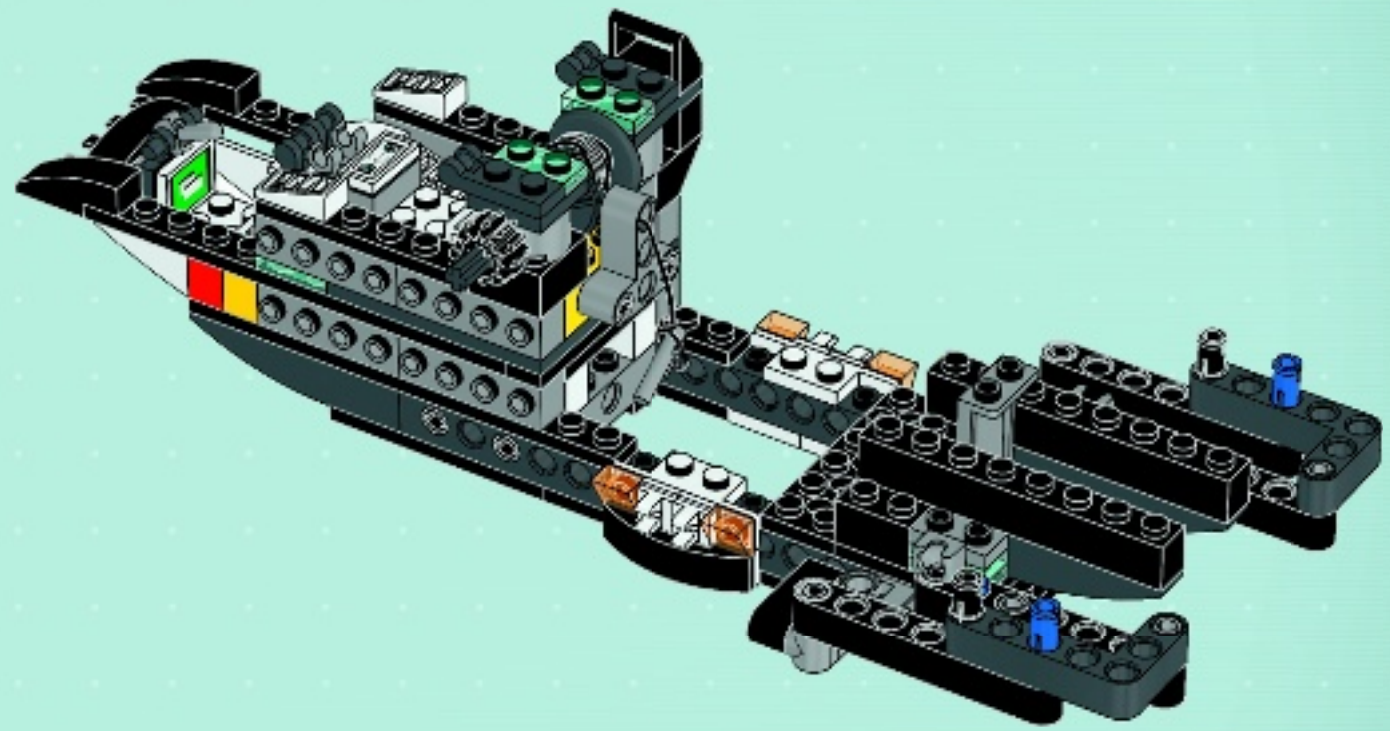

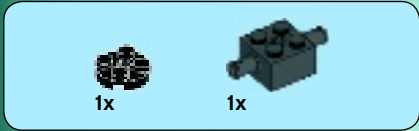
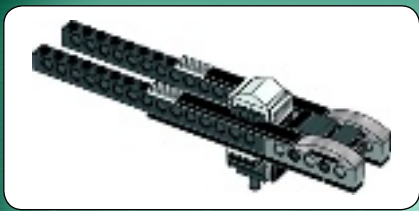

1



2



3



4

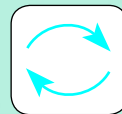

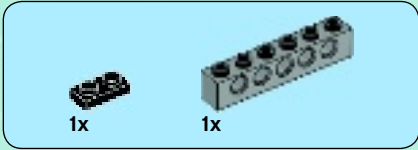

1



2

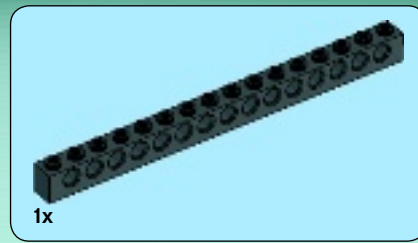

3

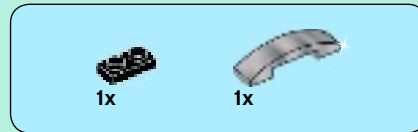
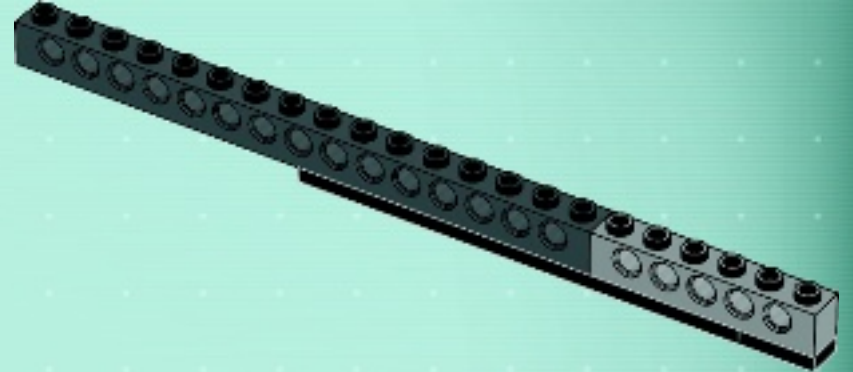

4

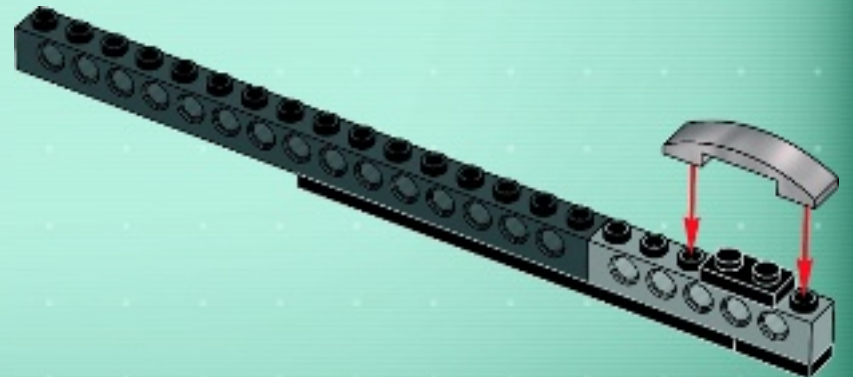

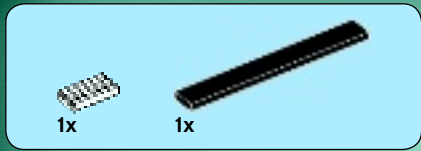

5

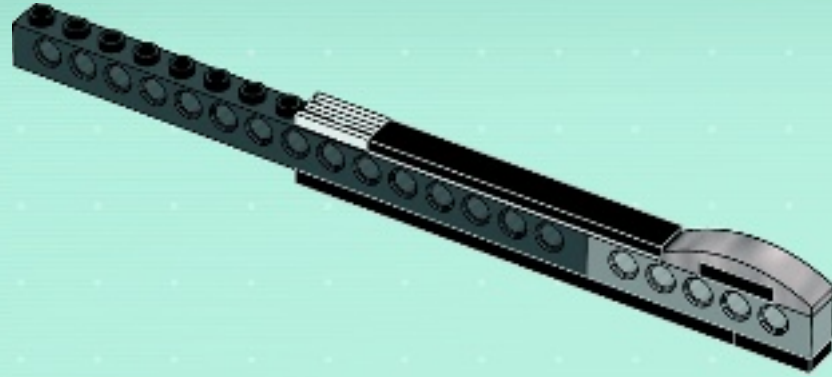

2x

6

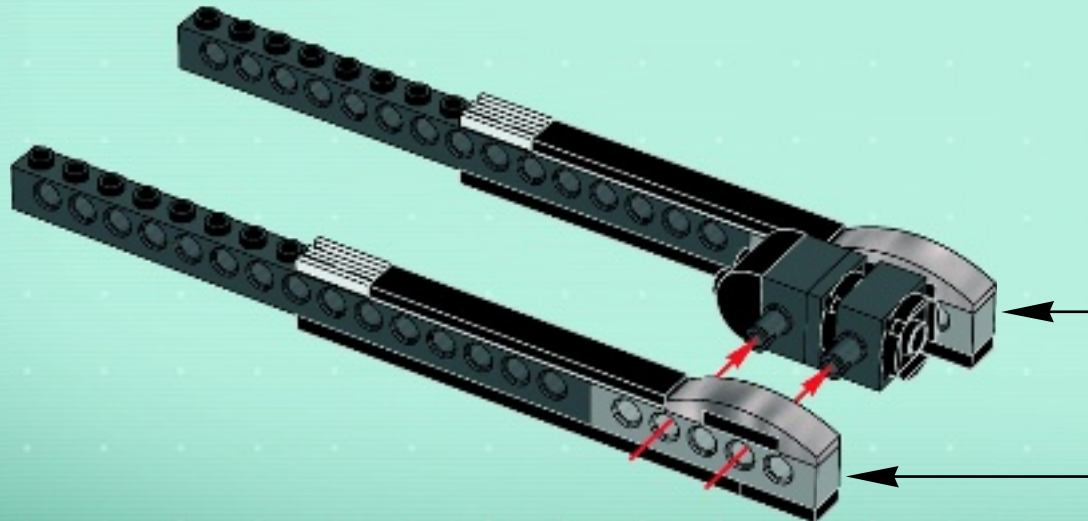



1x

1



2x

2



2x

3



1x

4





2x

5



2x

6



2x

7



2x



1x

8

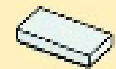

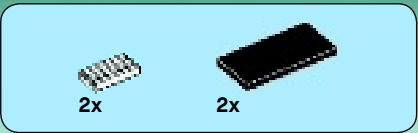

9

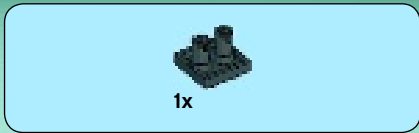
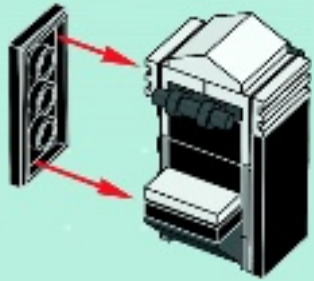

10



11

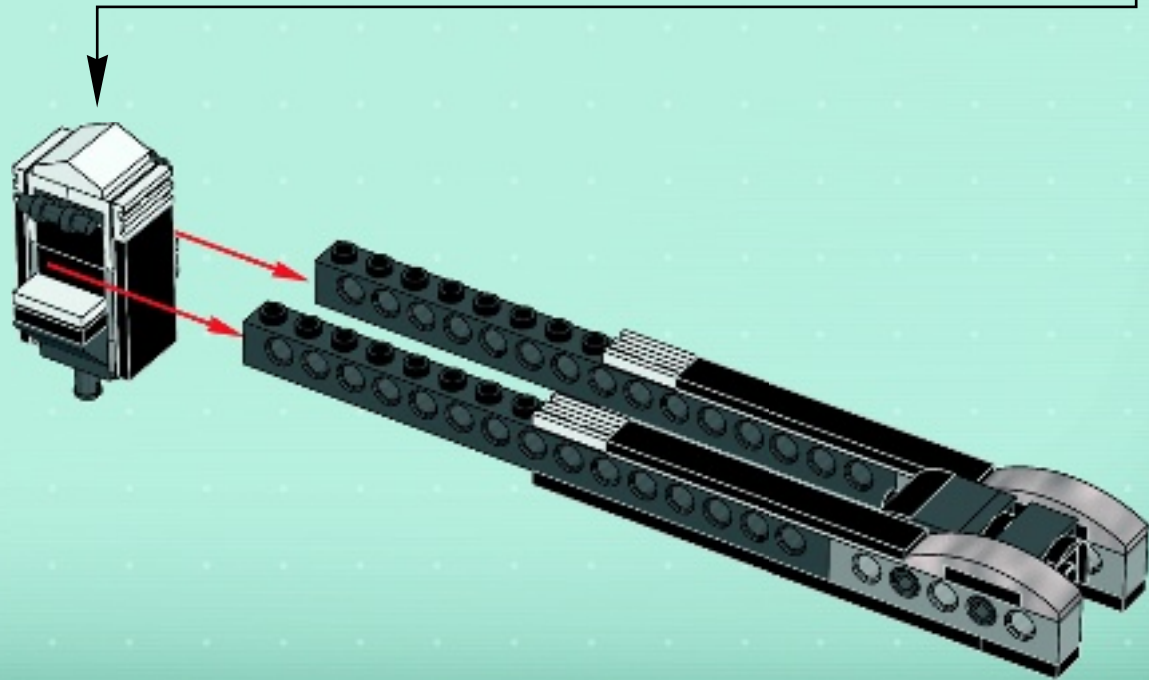

33

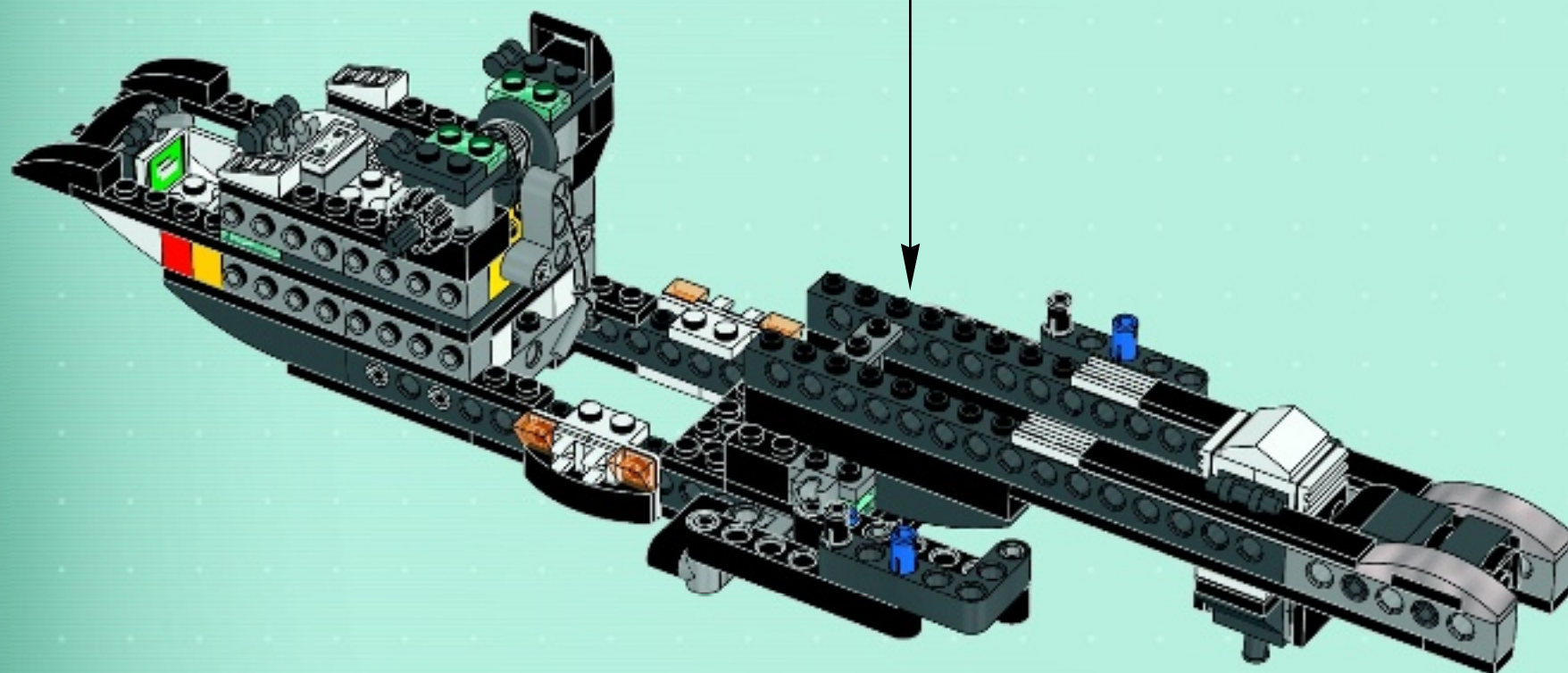

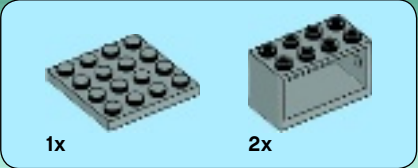

34

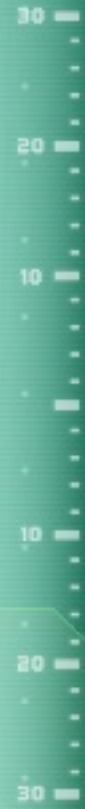
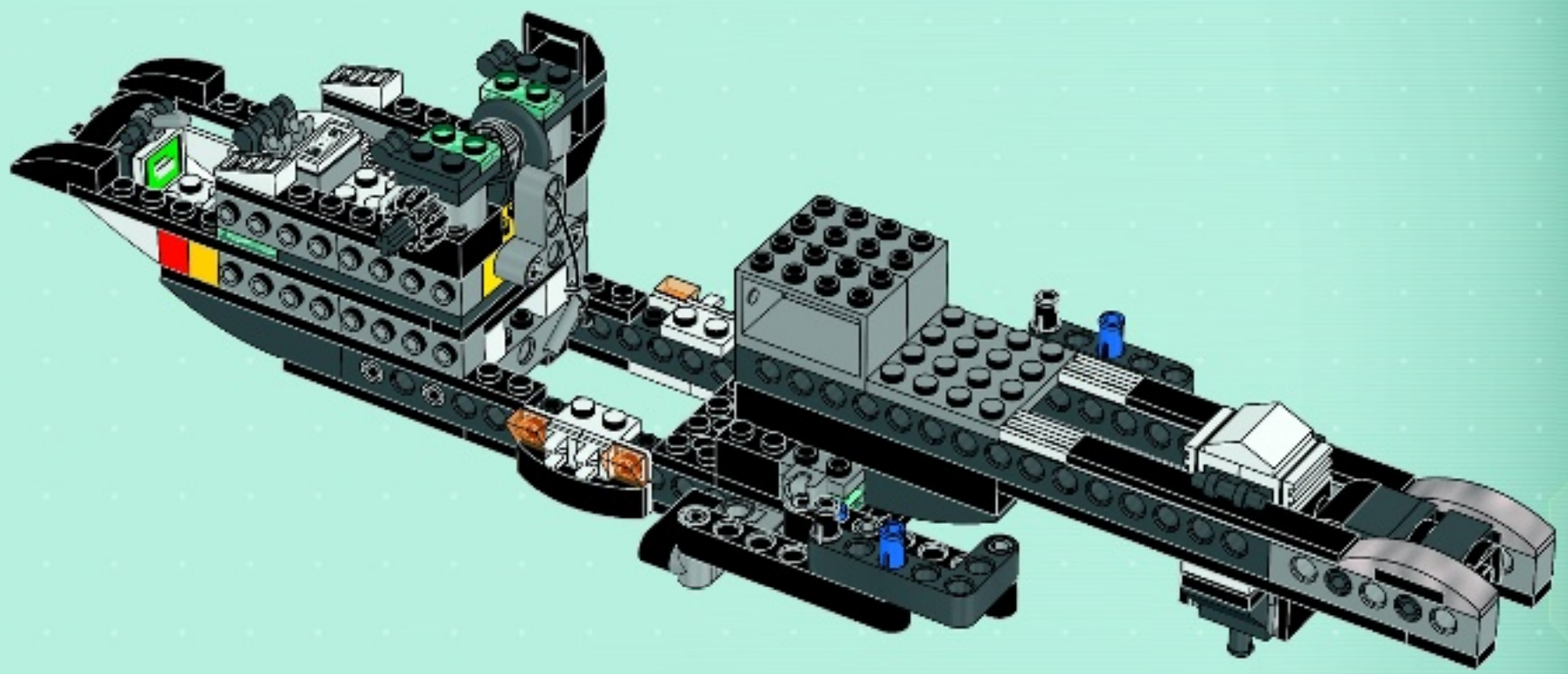

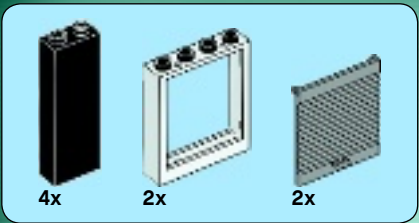

35

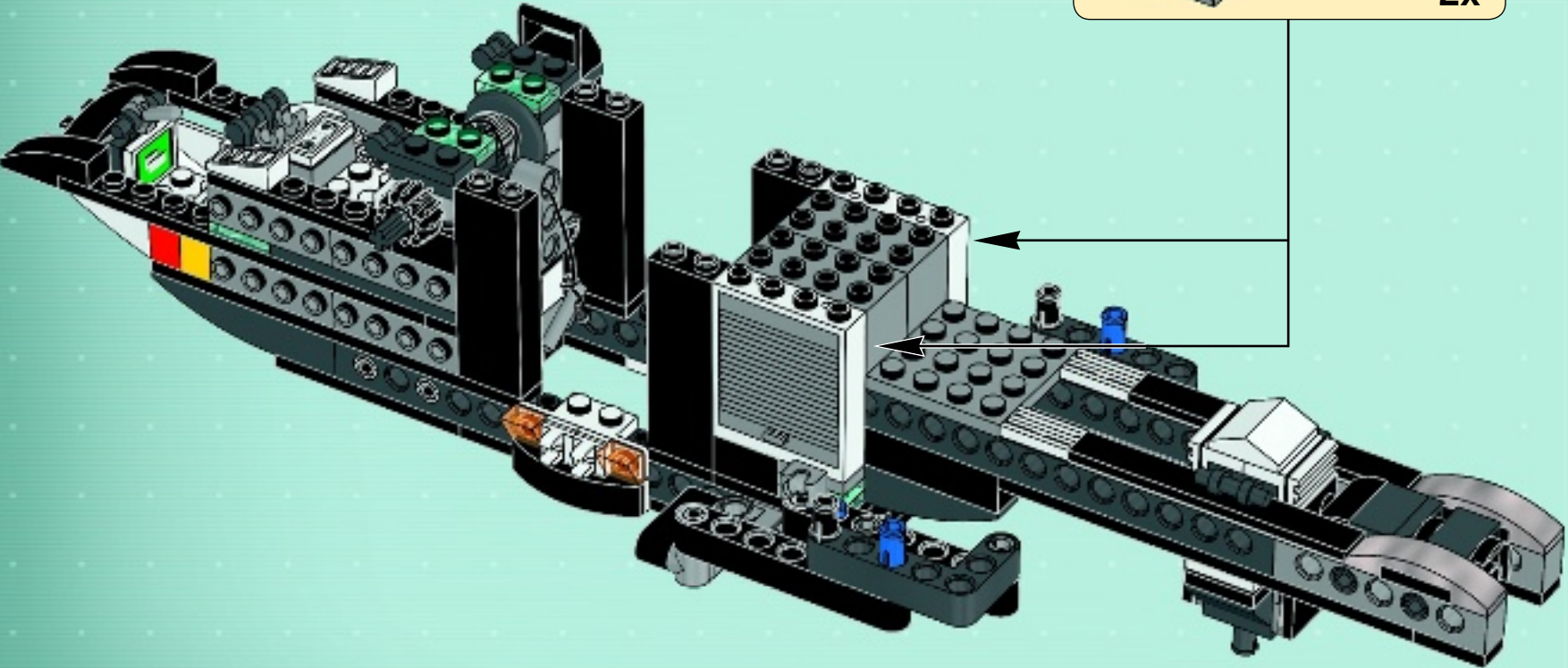
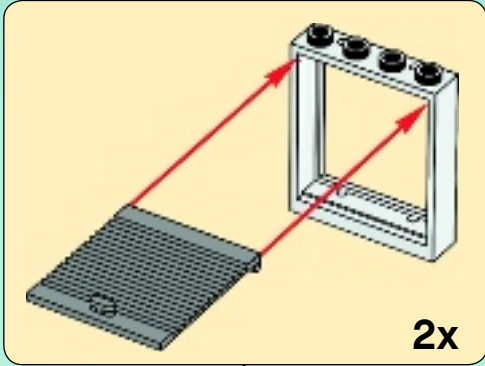

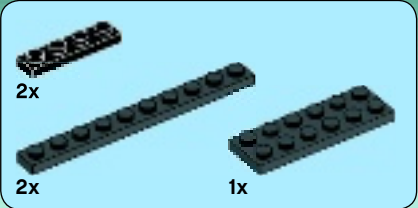

36

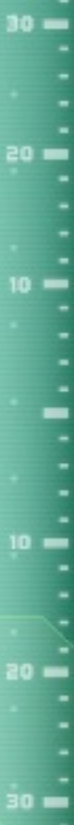
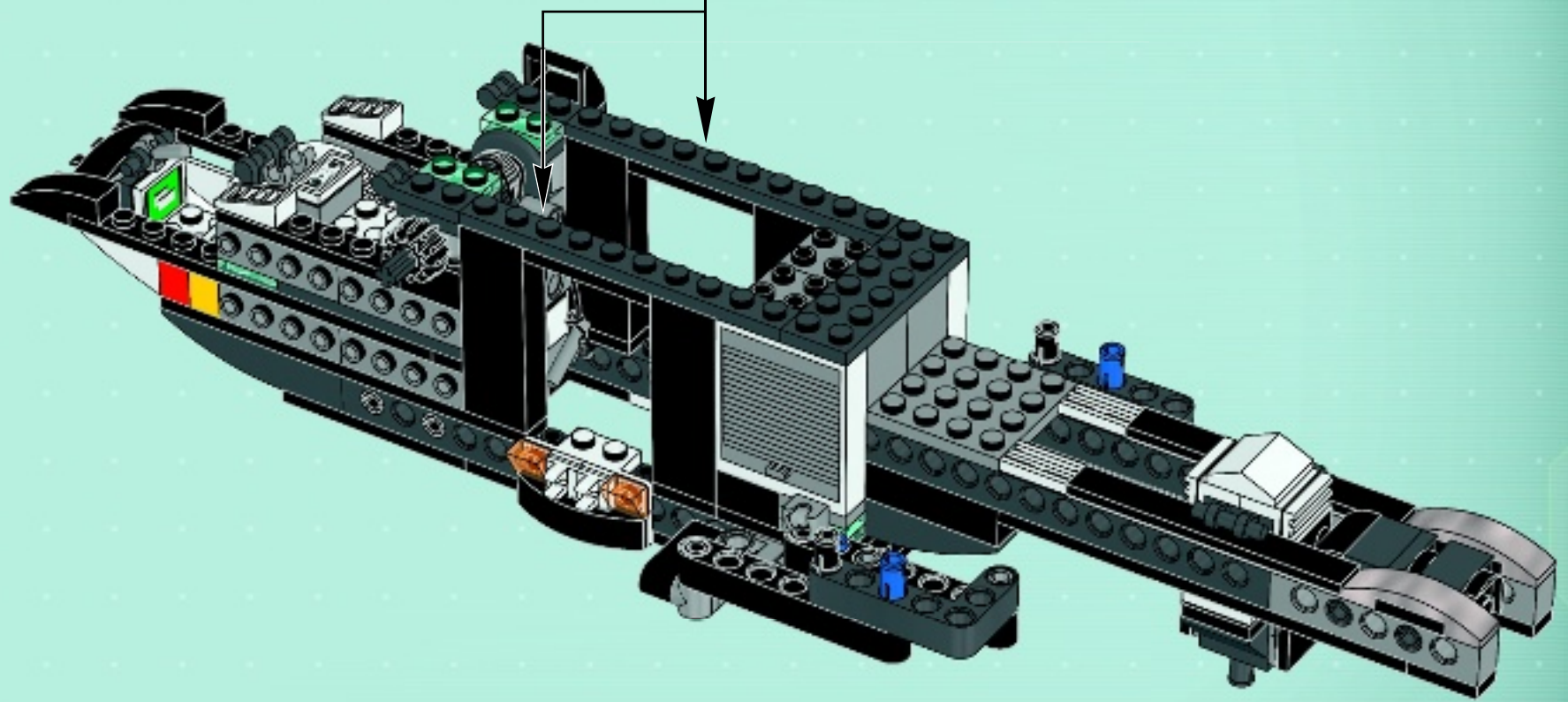
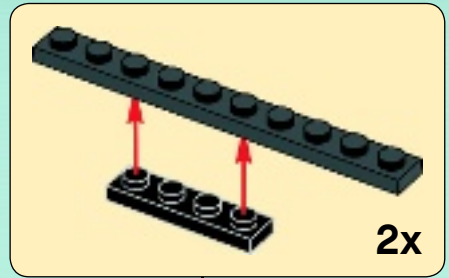

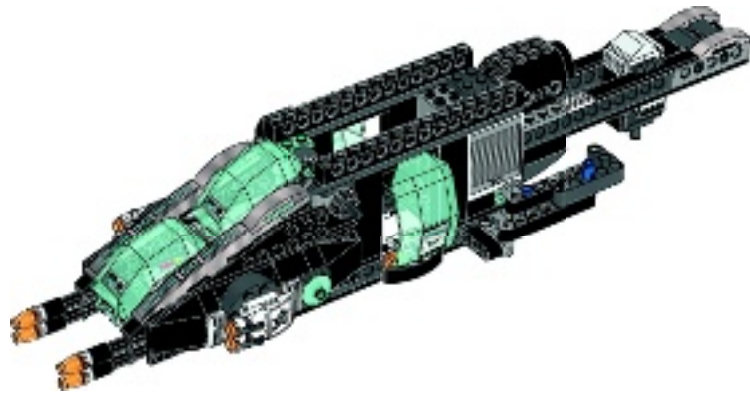

2x

37

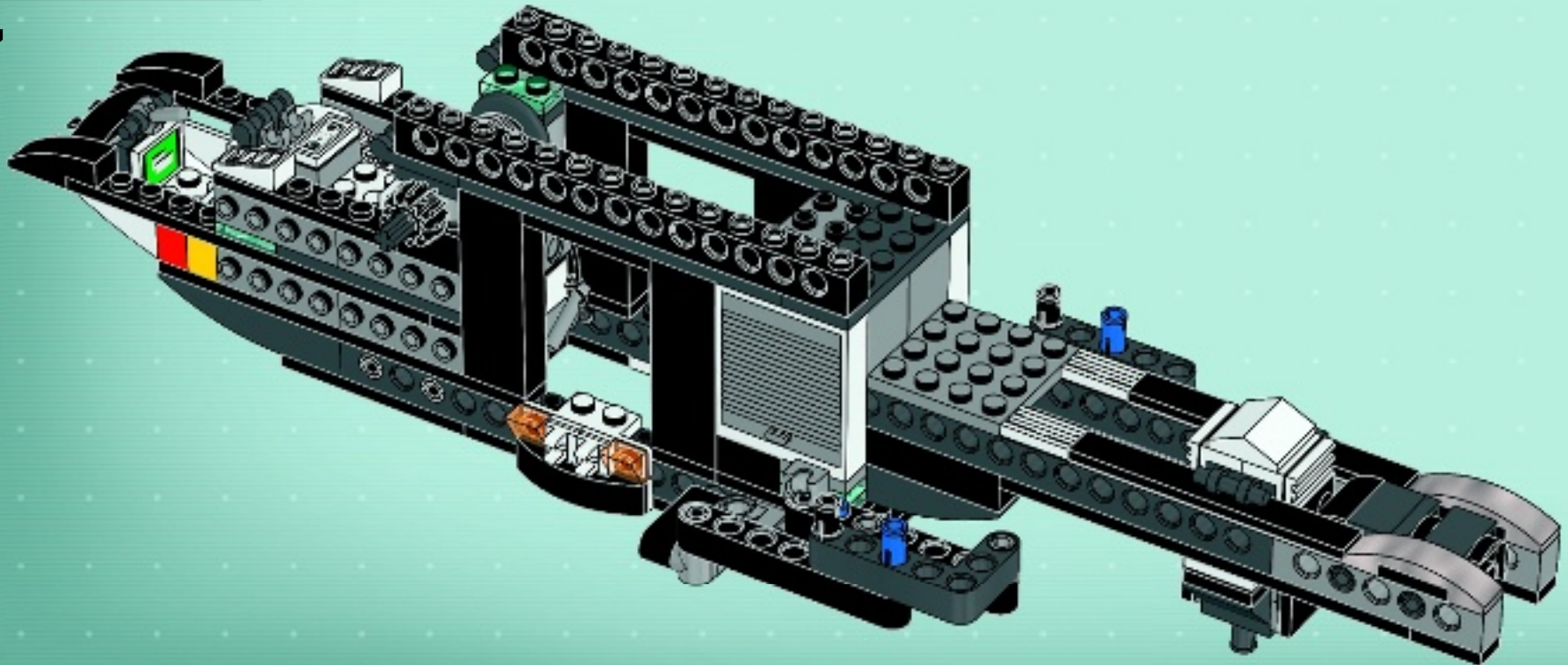

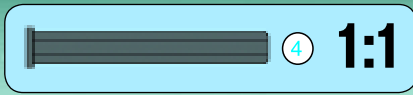

38

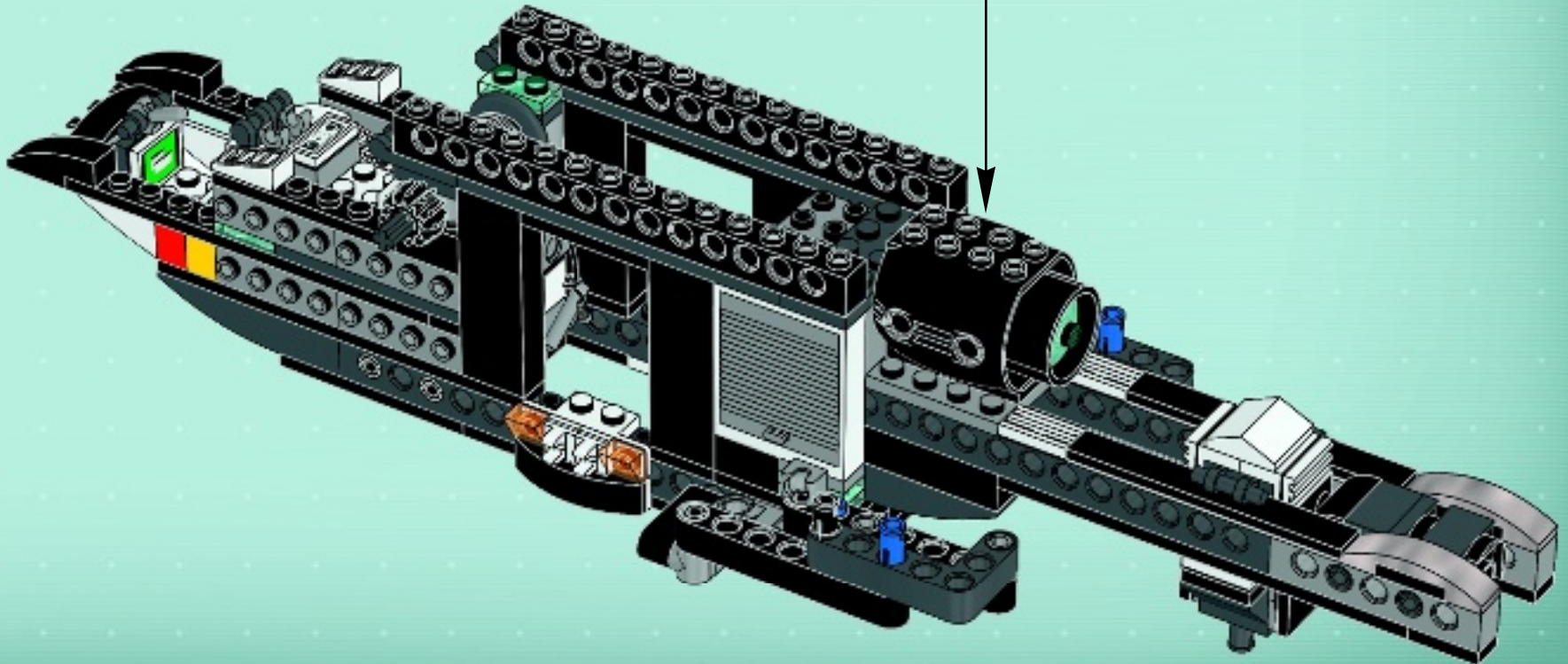
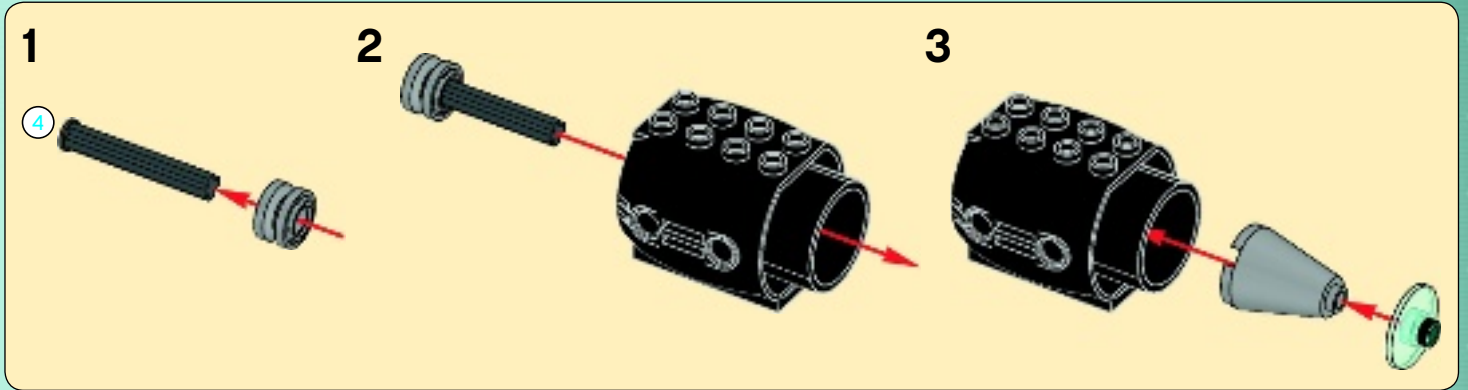

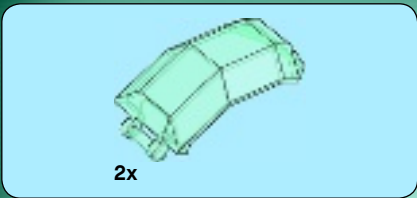

39

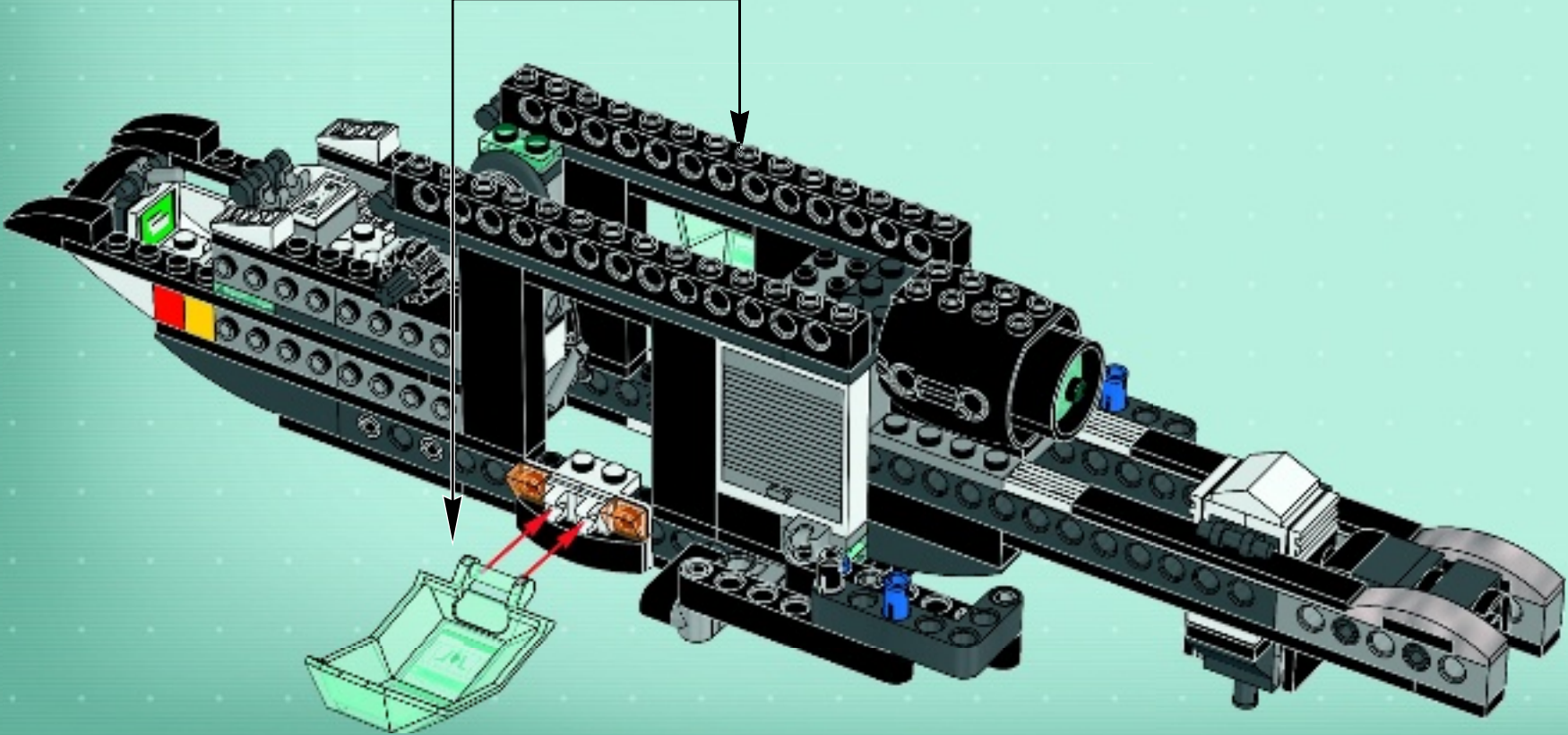
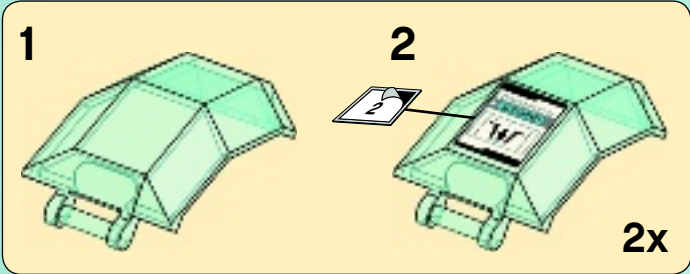



40

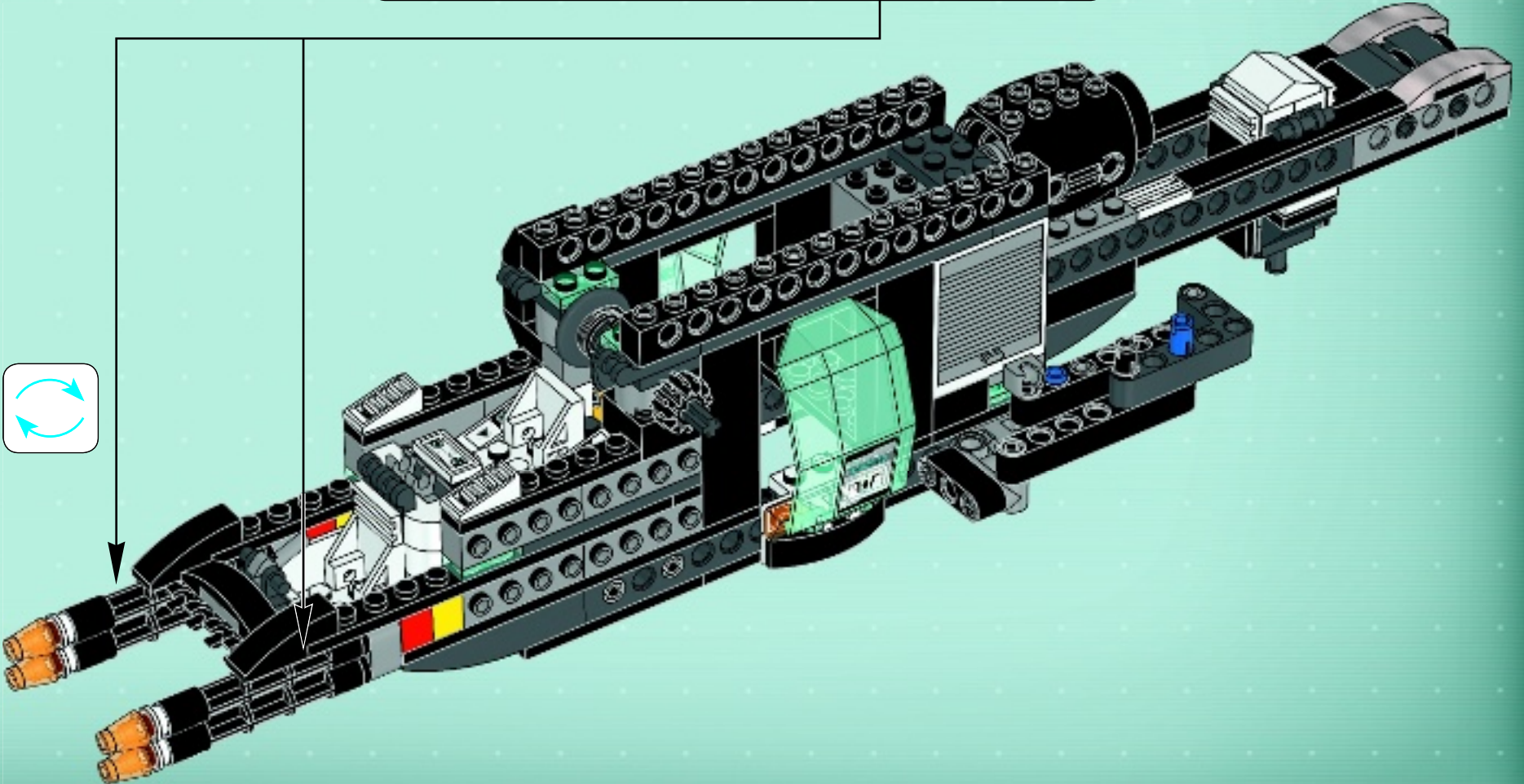
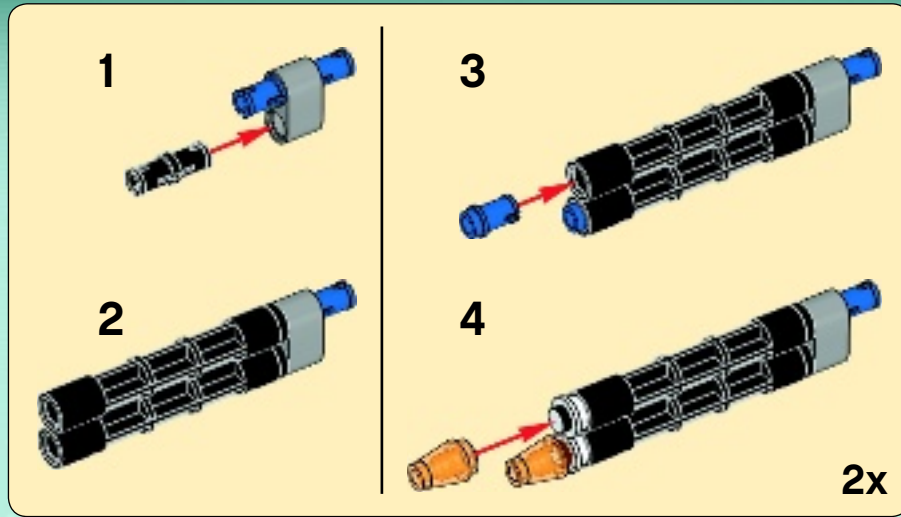

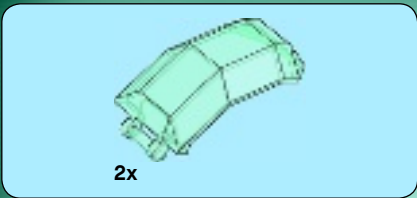

41

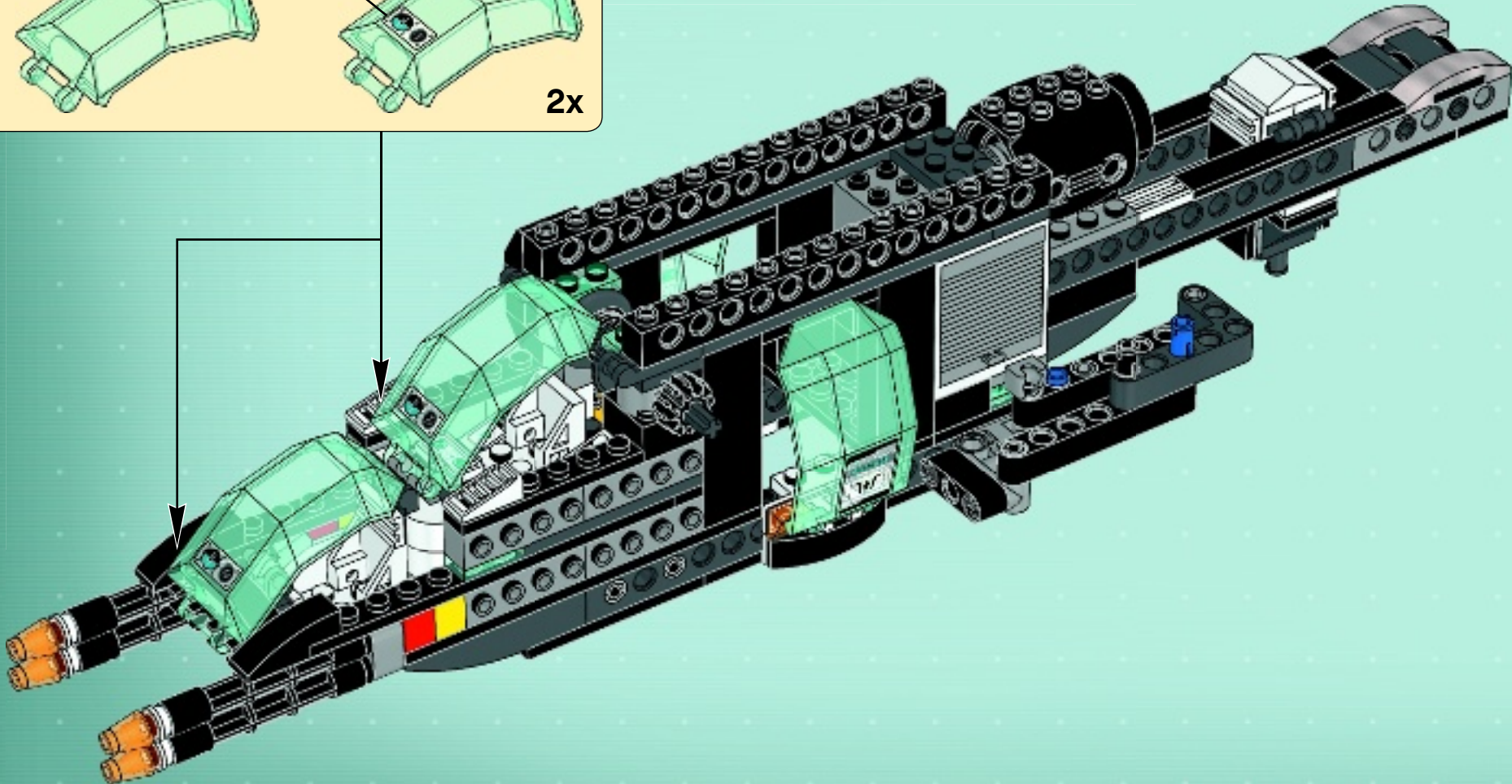
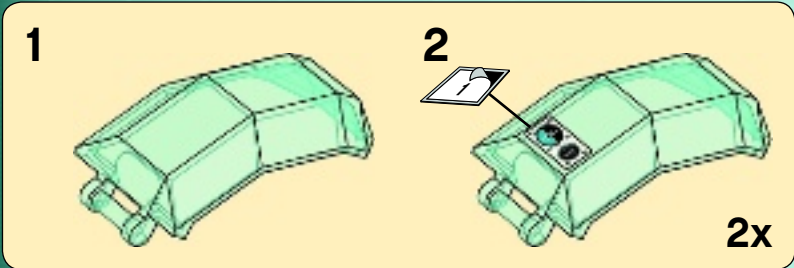

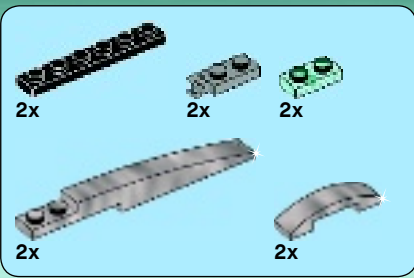

42

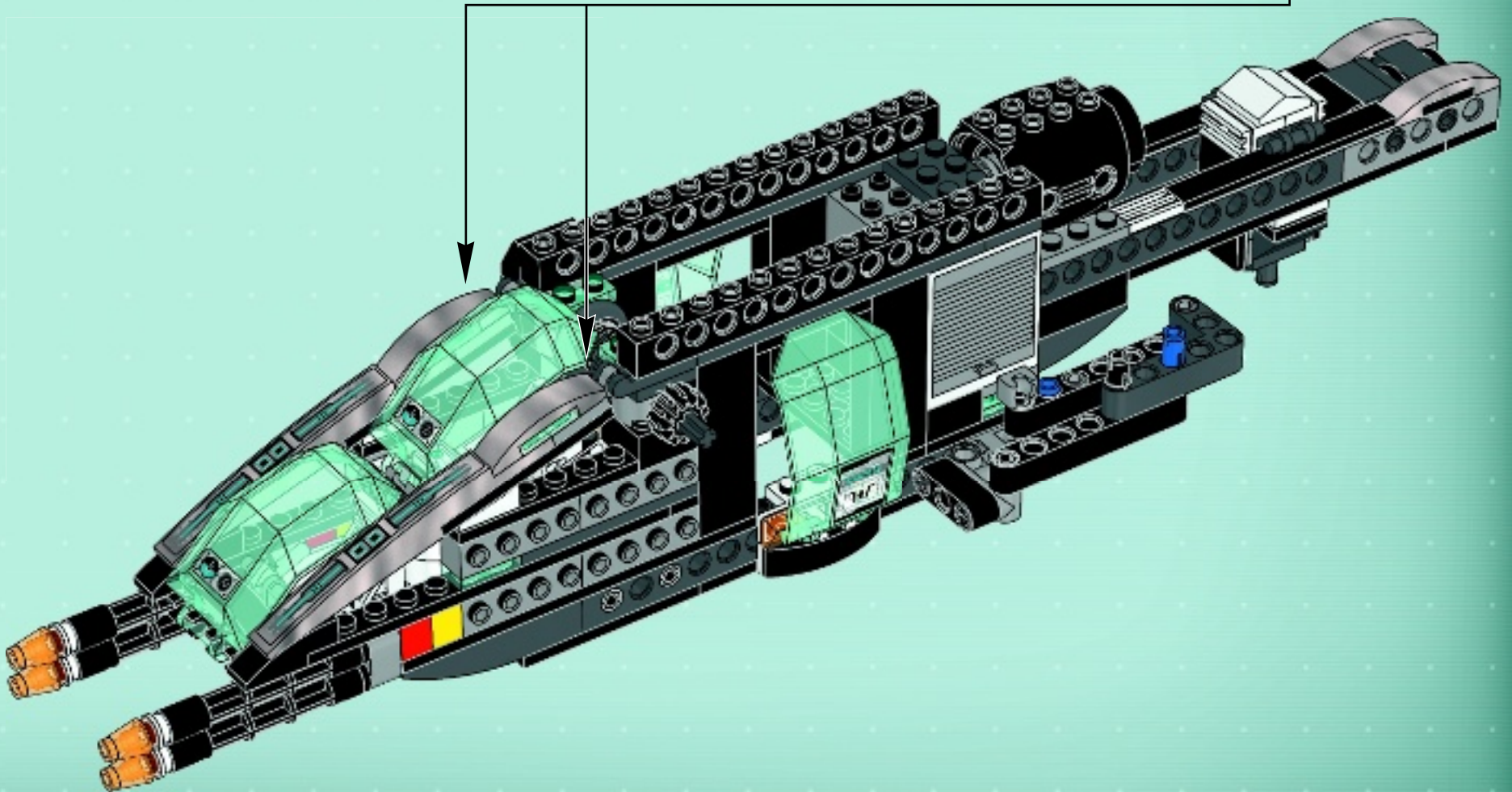
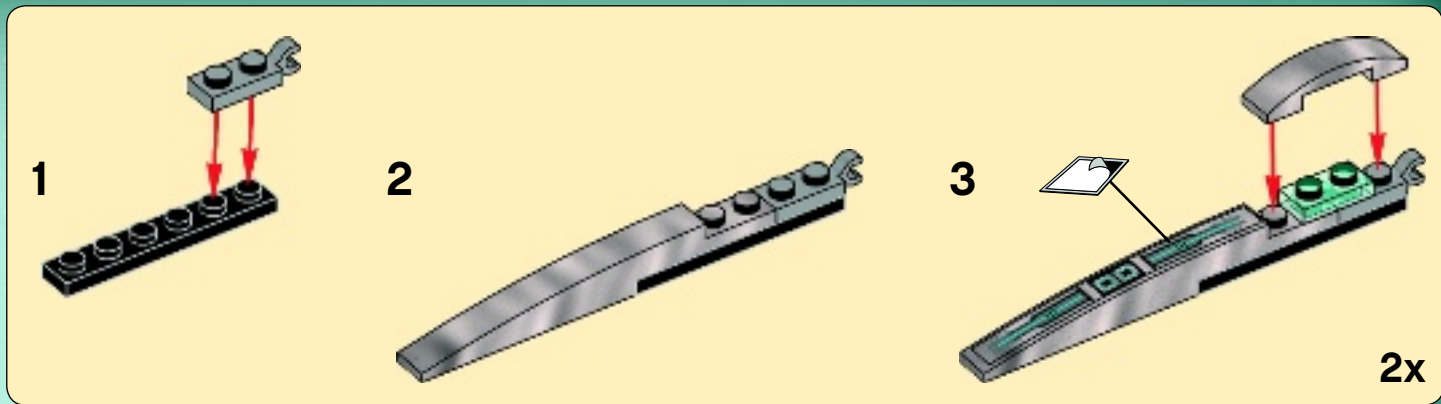

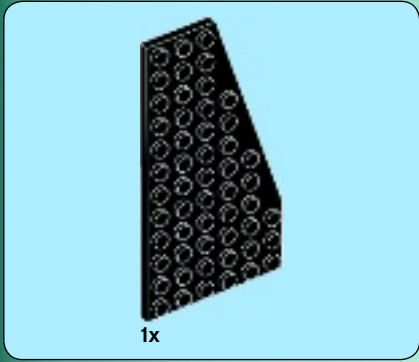
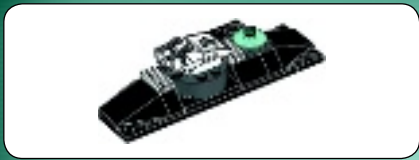

1x

1

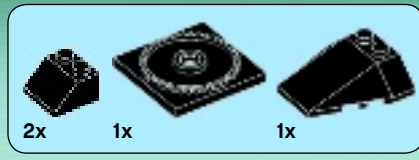

2x

1x

1x

2

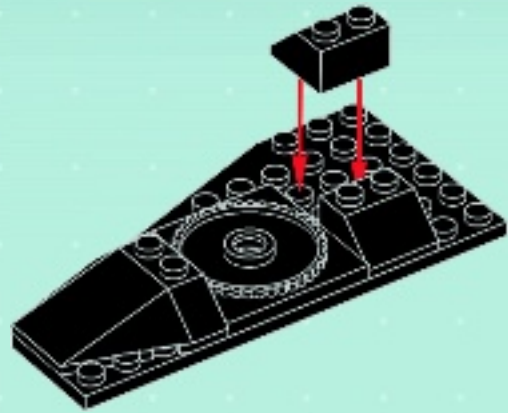

1x

3





4



5



6

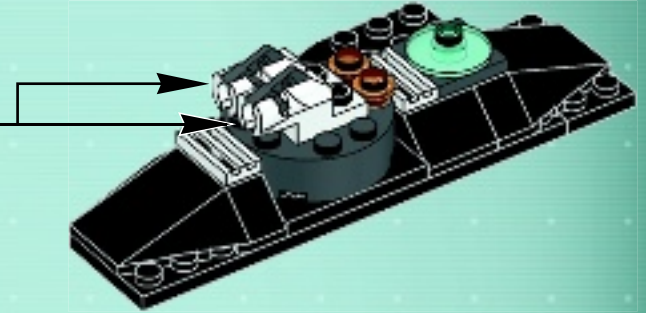
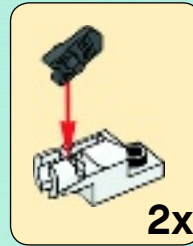

7

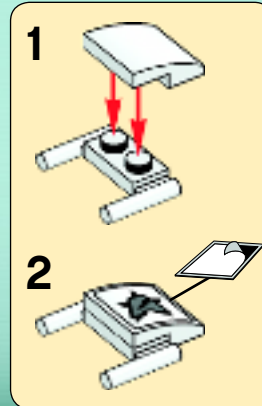

43

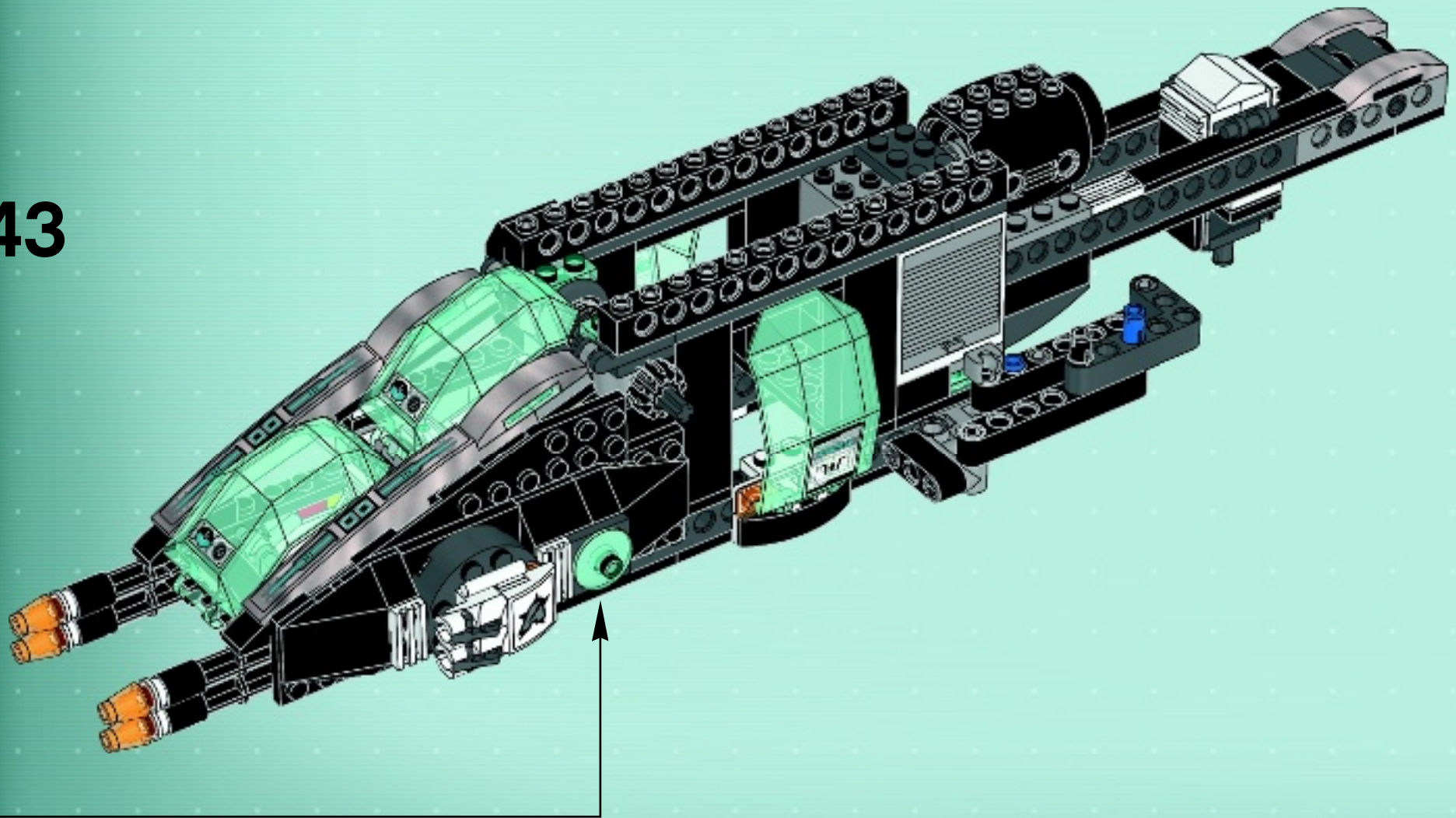

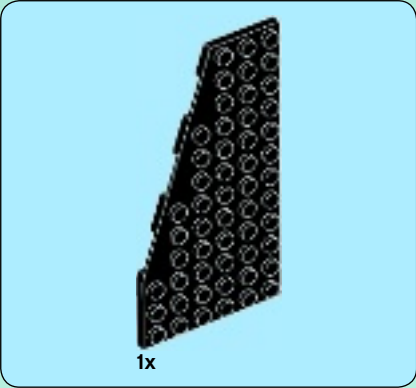
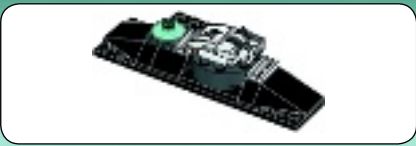

1



2

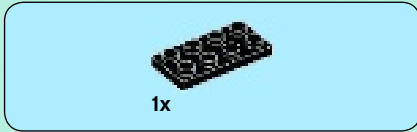
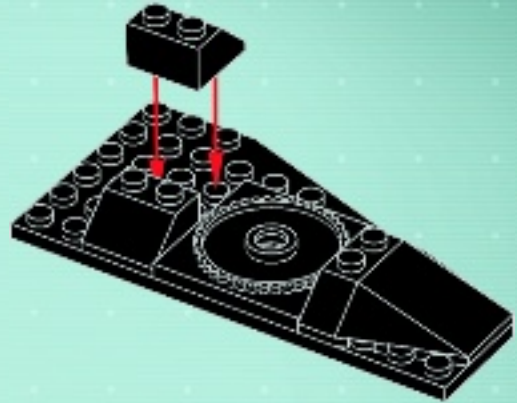

3





1x

4

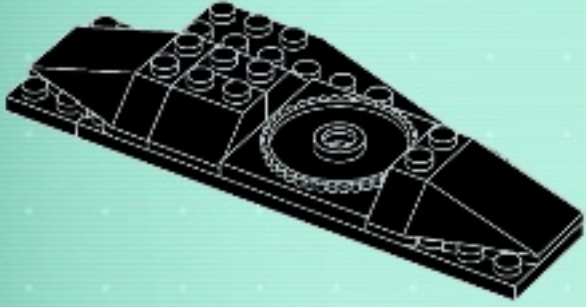

2x



1x



1x

5



2x



2x



1x



2x



6

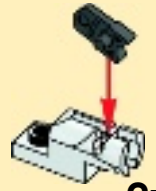

2x



1x



1x

7

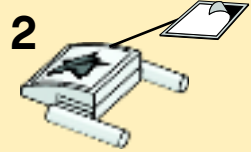
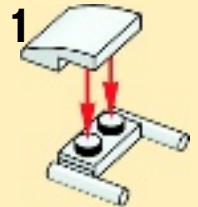

44

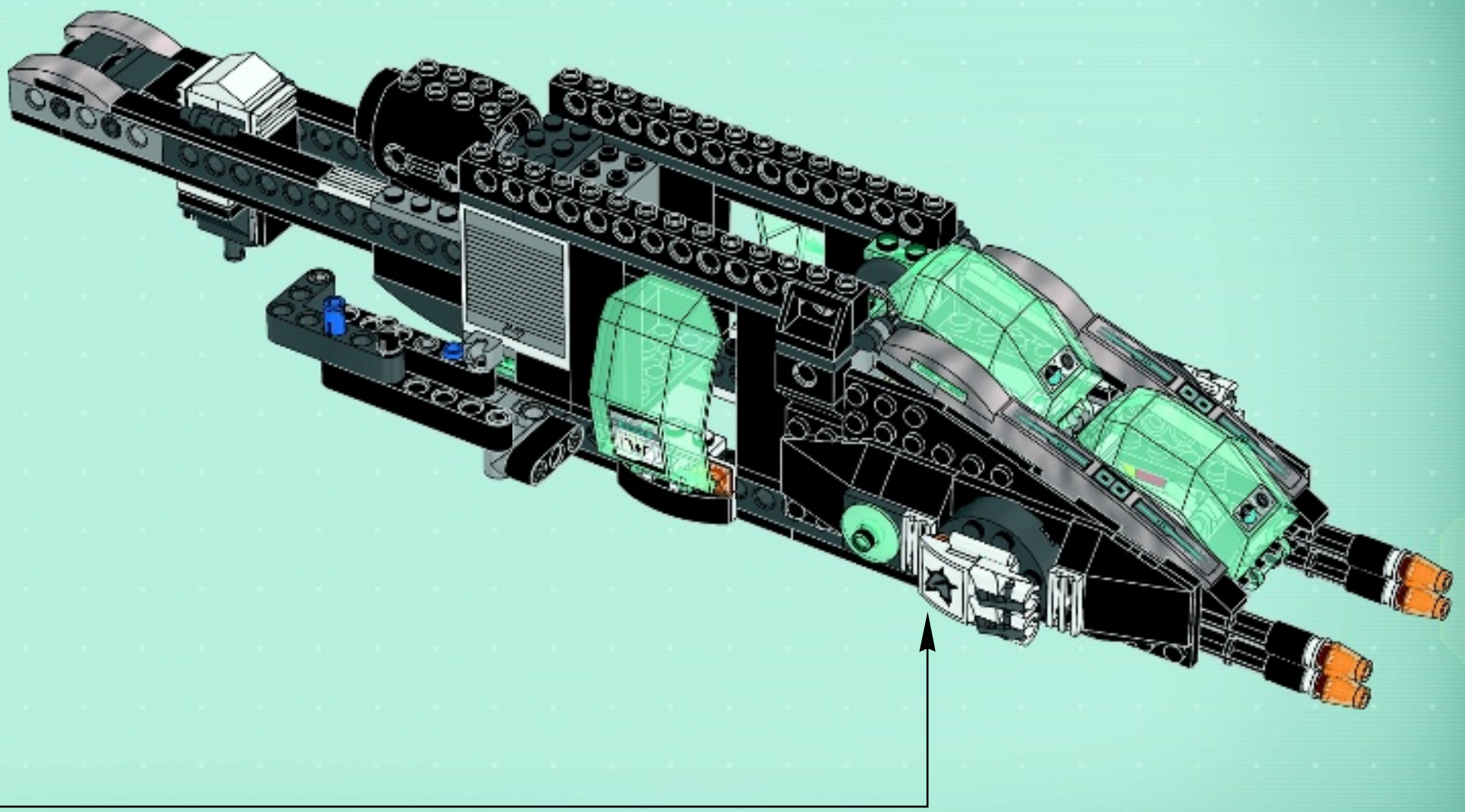
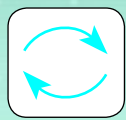

30
20
10
10
20
30



4x



45

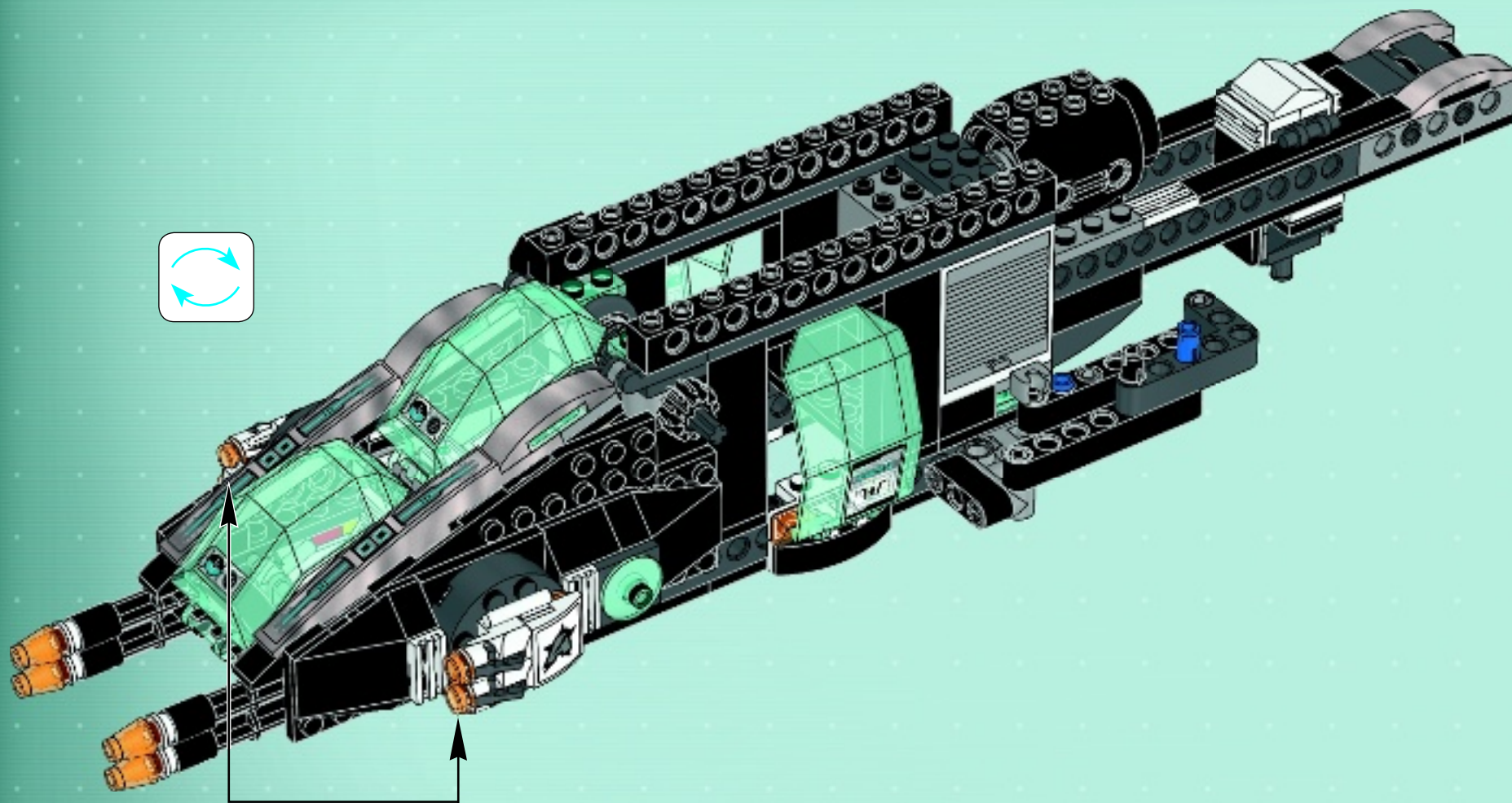
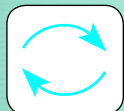

4x



4

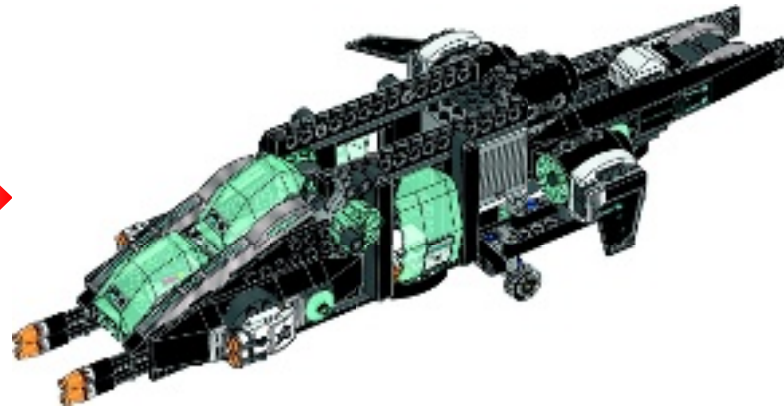

46

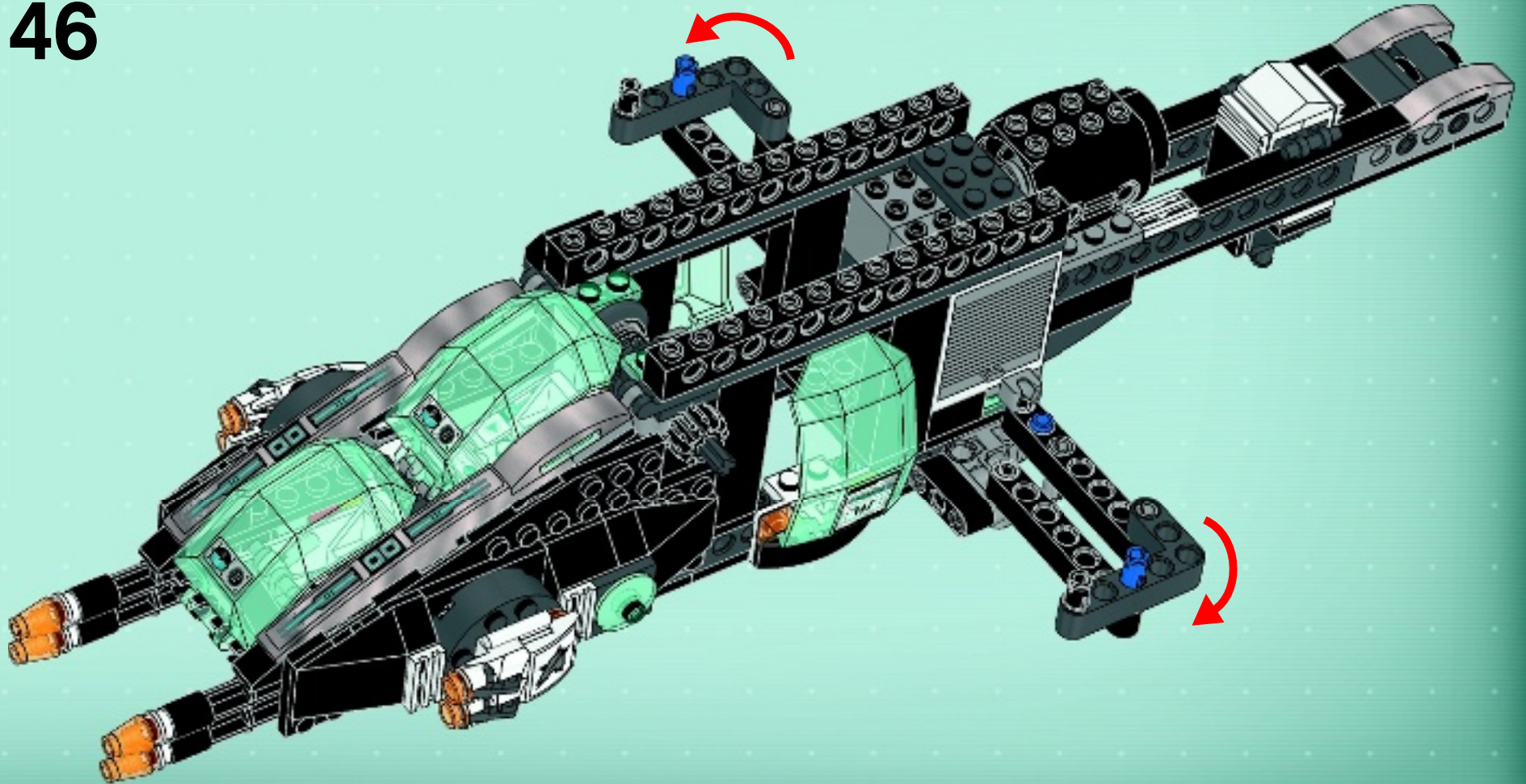

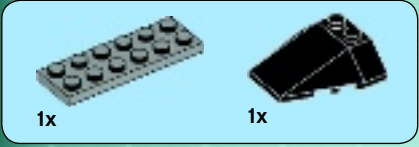

1

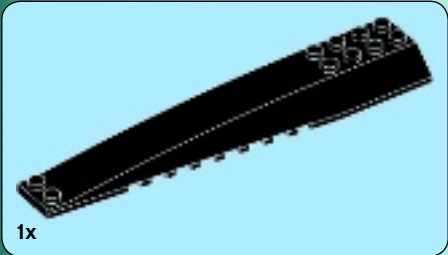
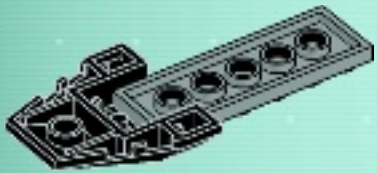

2

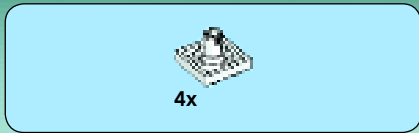
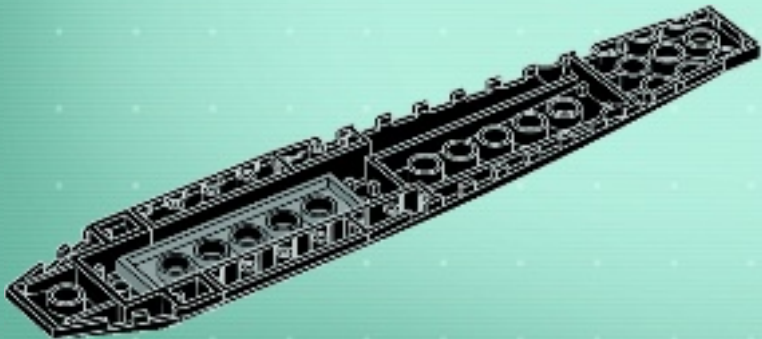

3

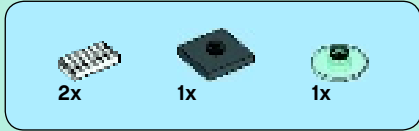
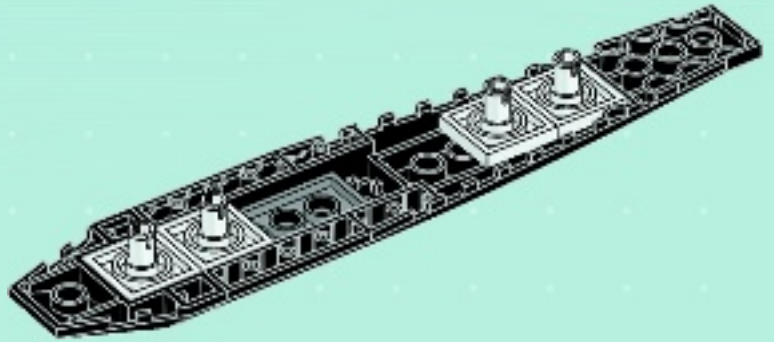

4

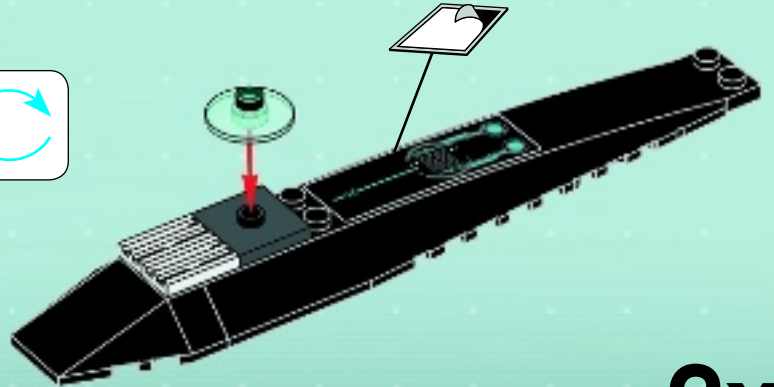
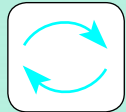

2x

47

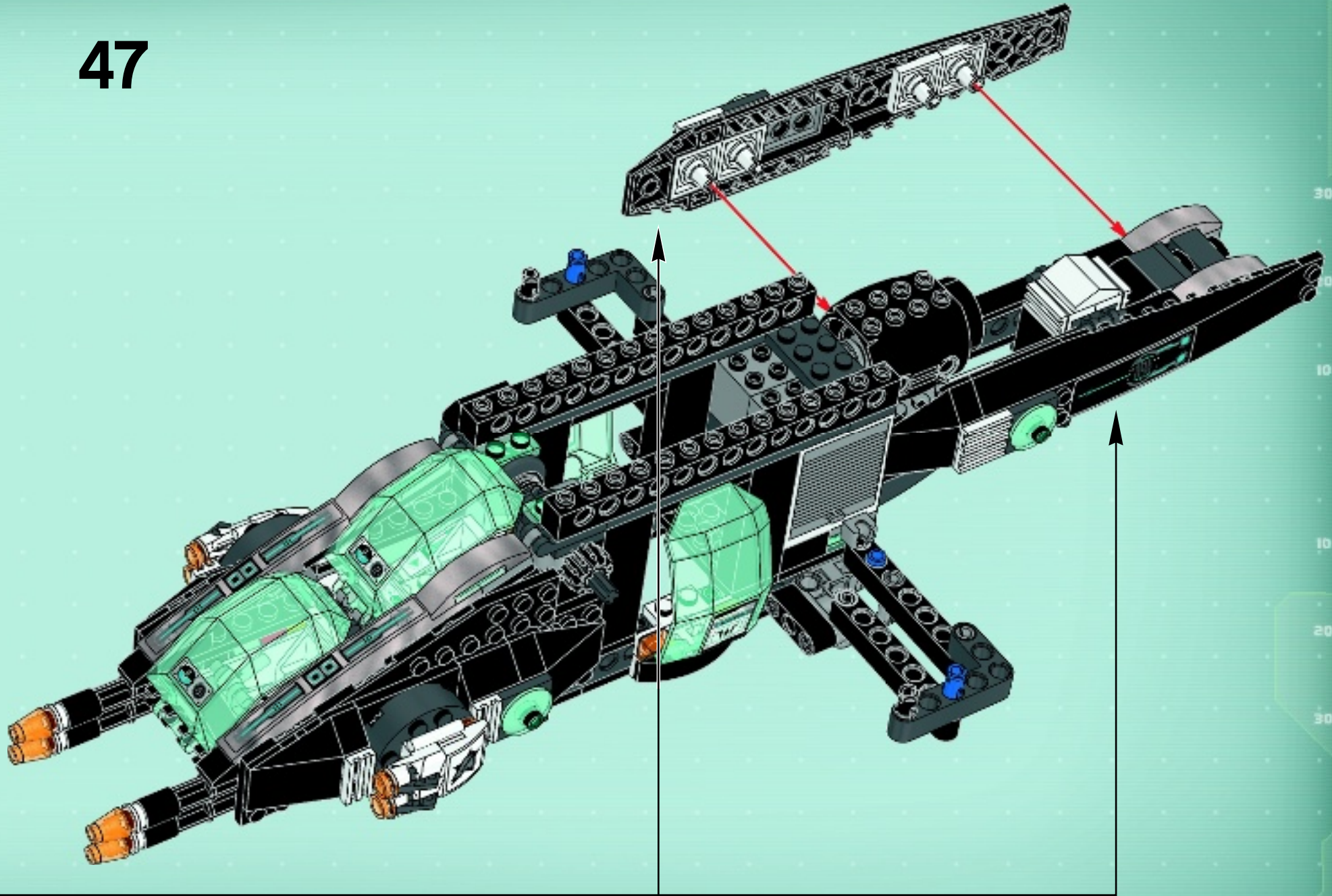

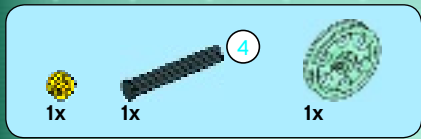
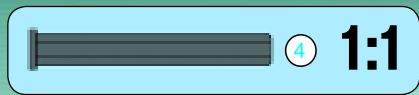

1



2

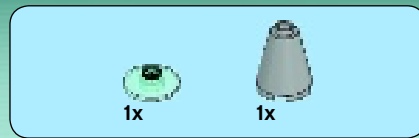

3

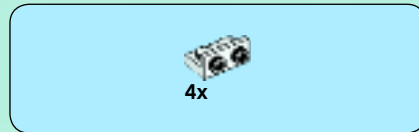
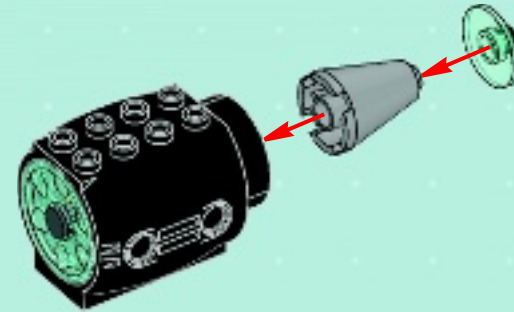

4





5



6

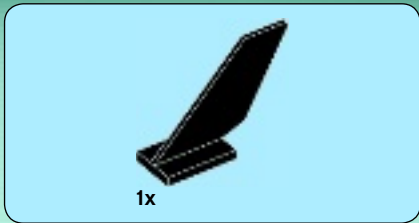
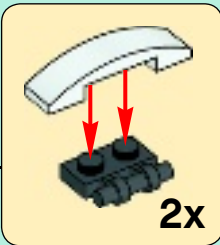

7



2x

48

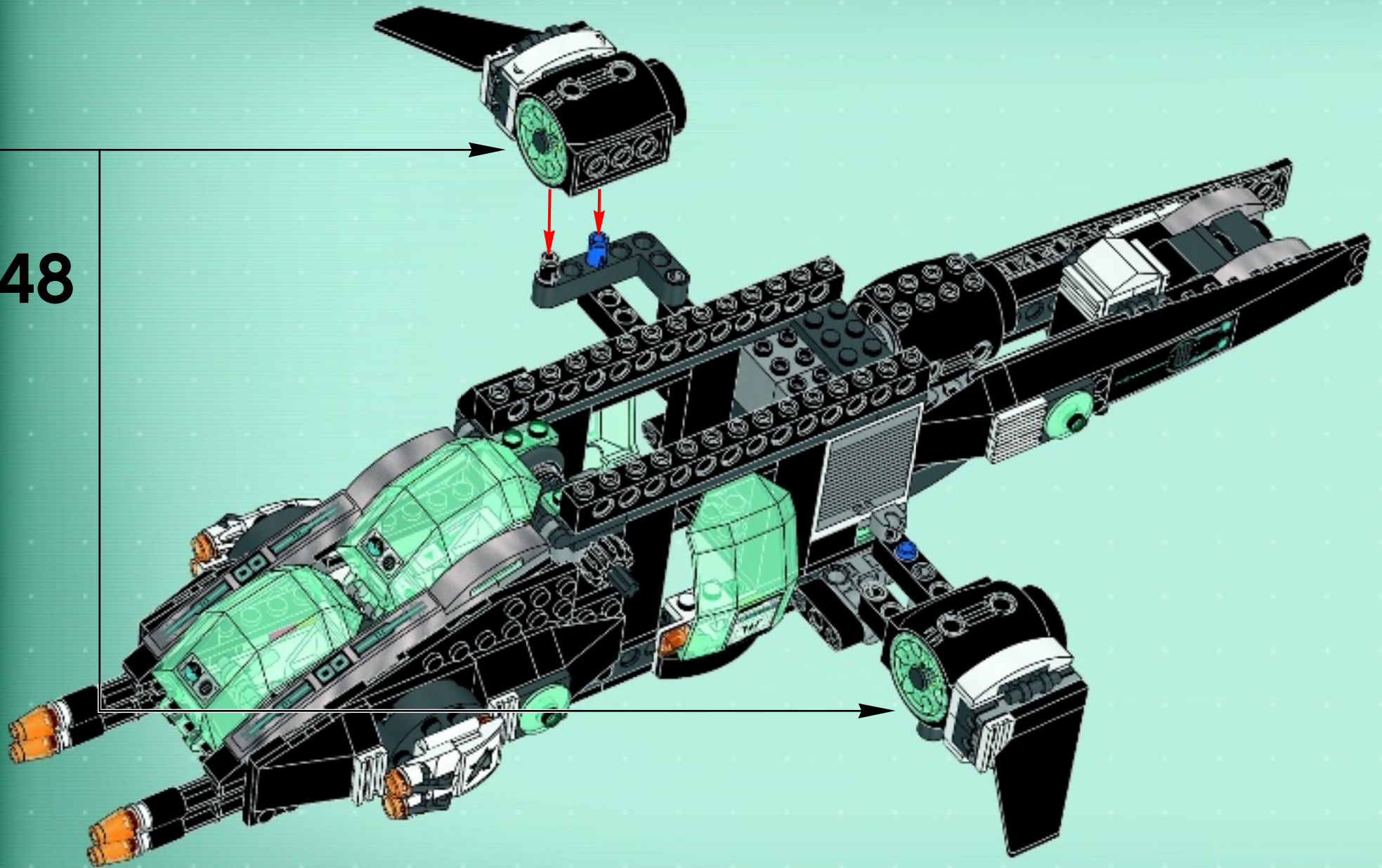

49

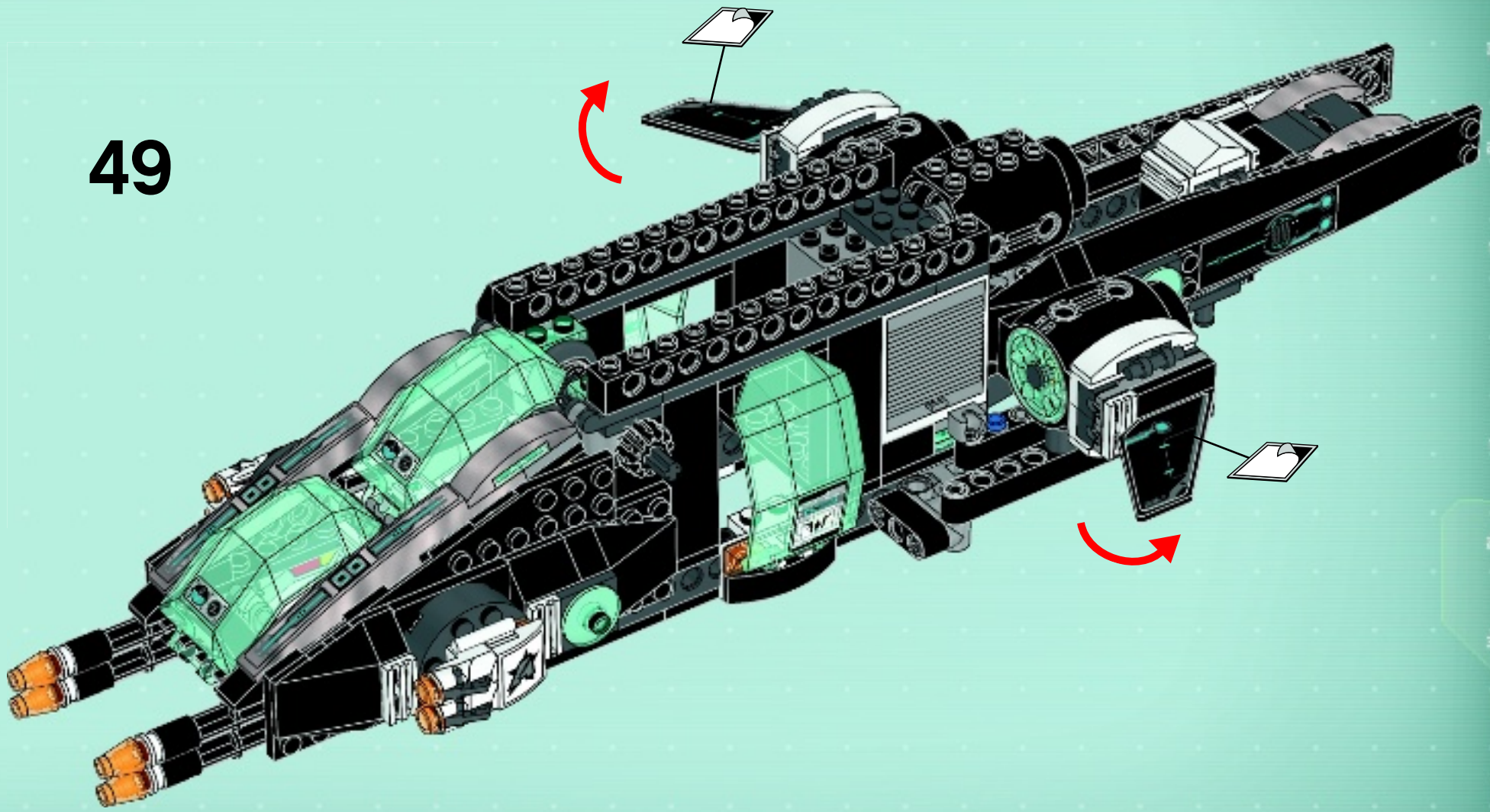

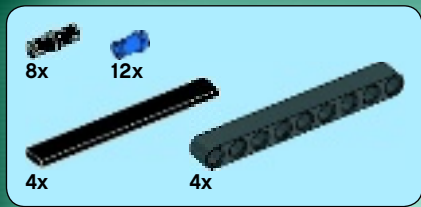

50

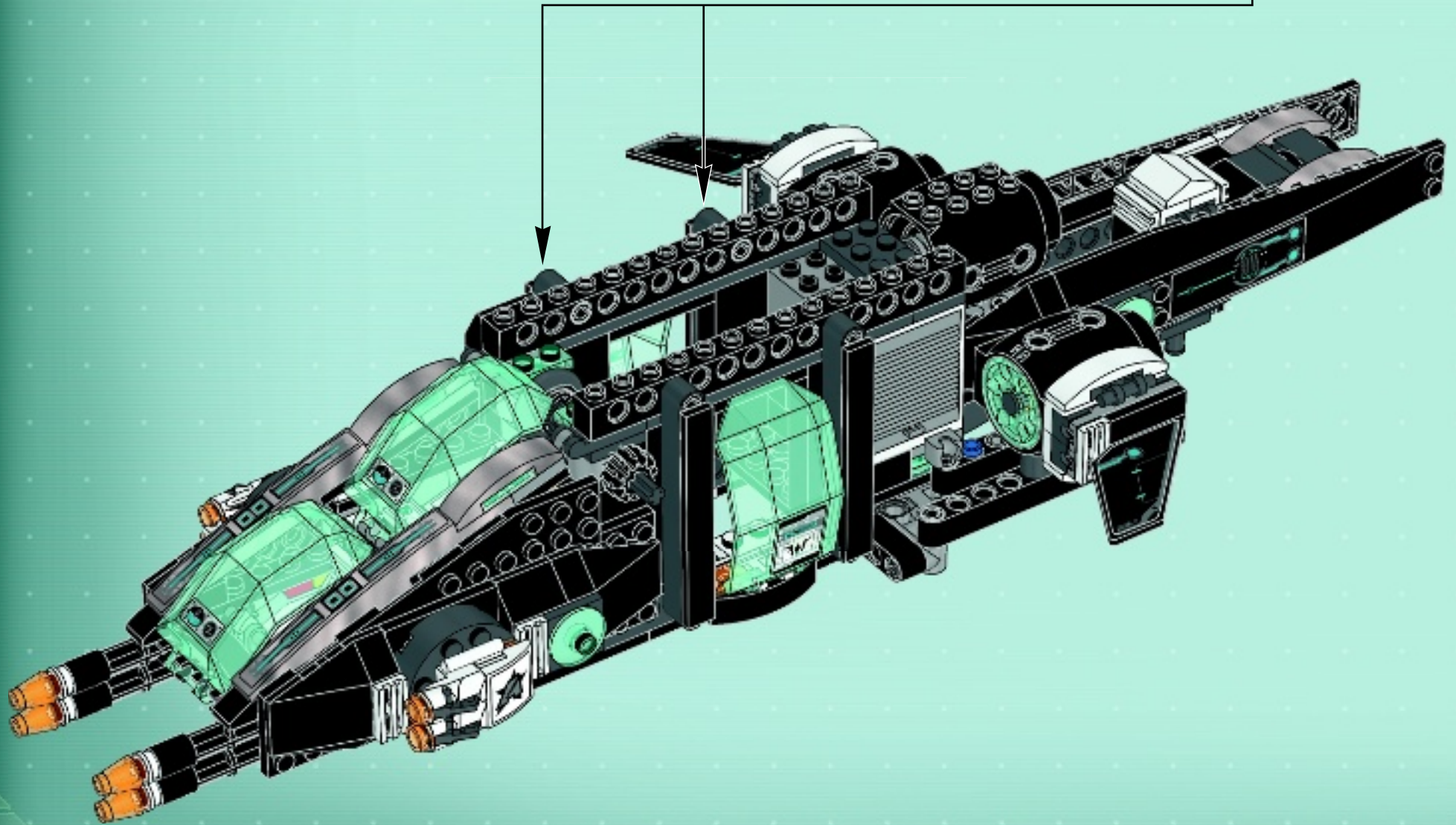
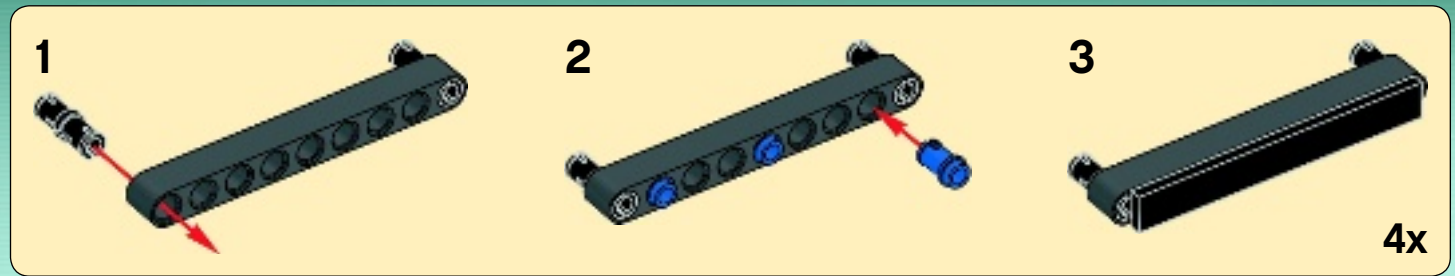



51

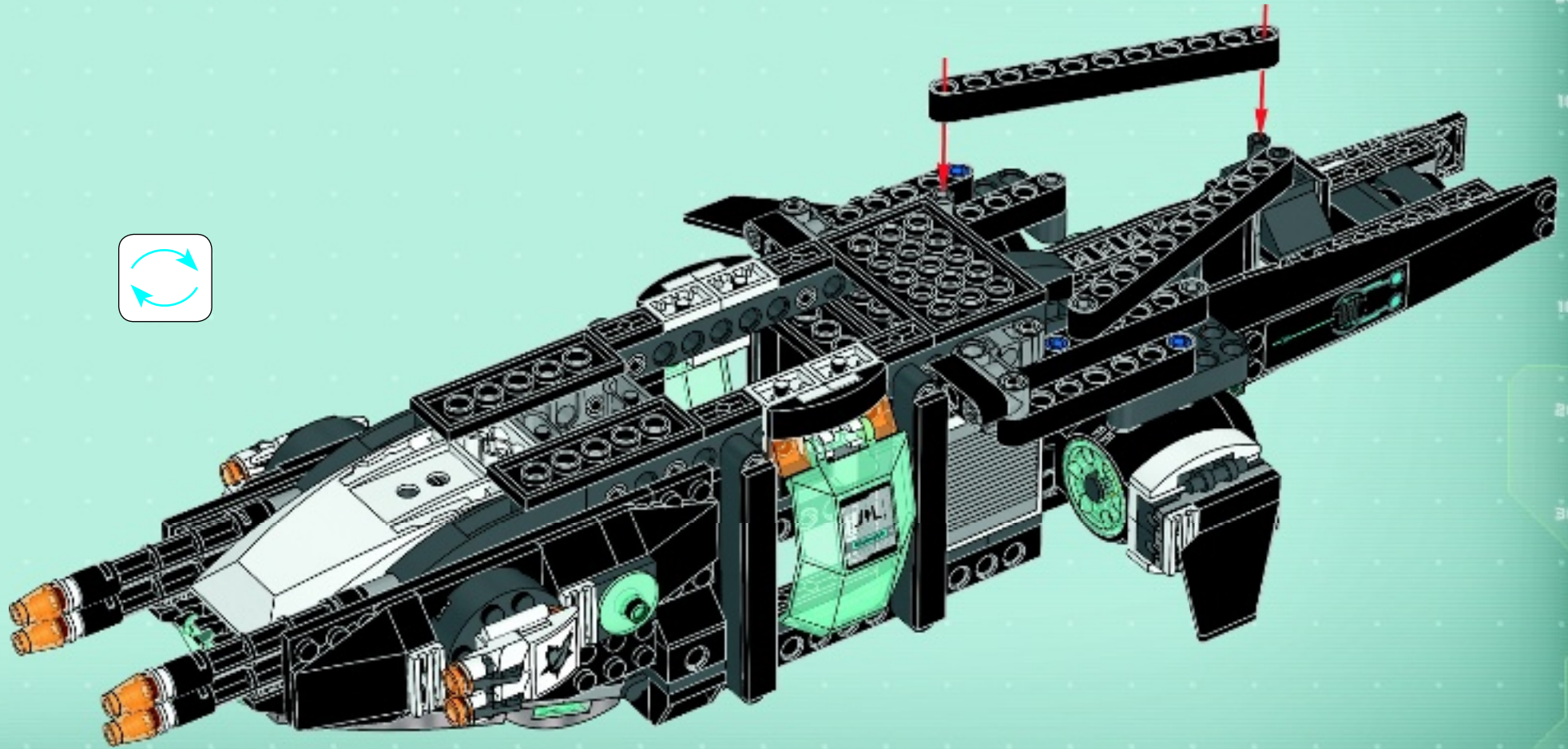
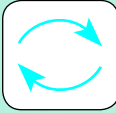



2x



2x

52

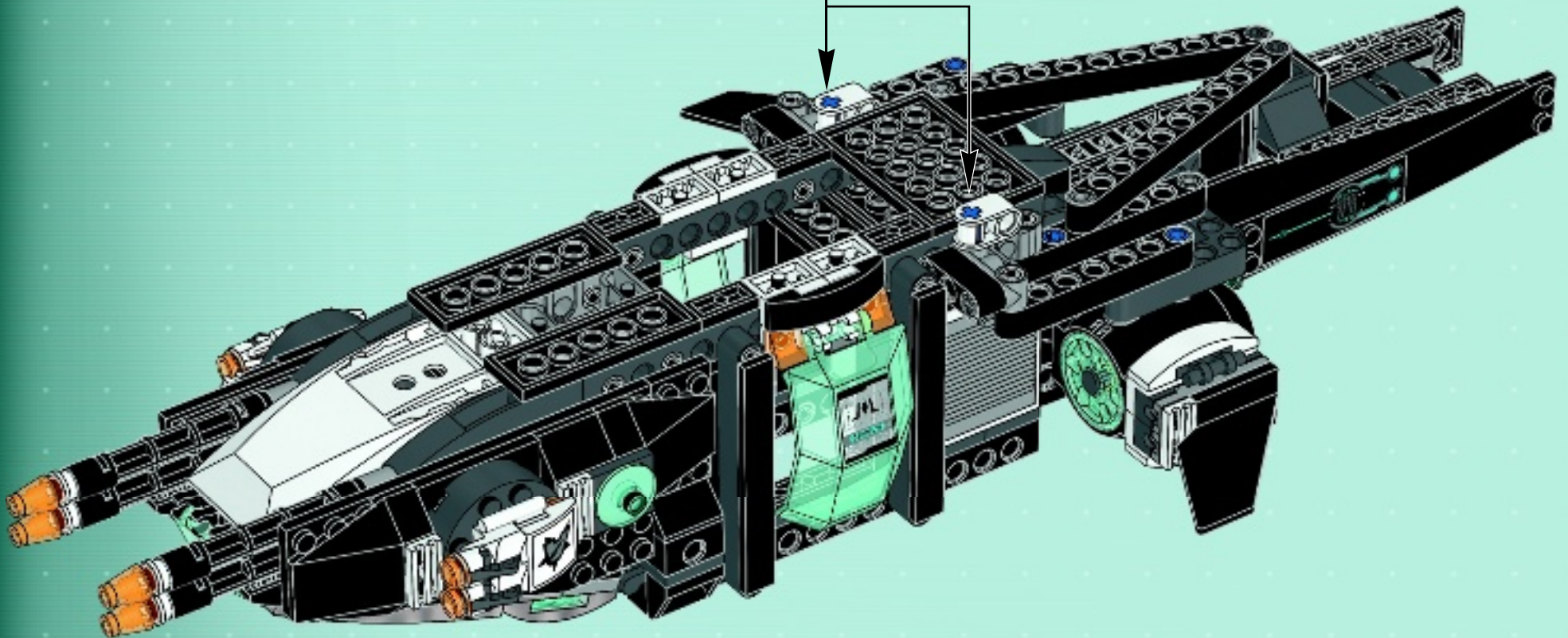
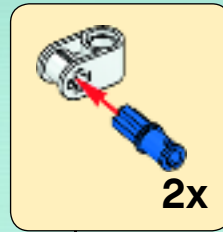



53

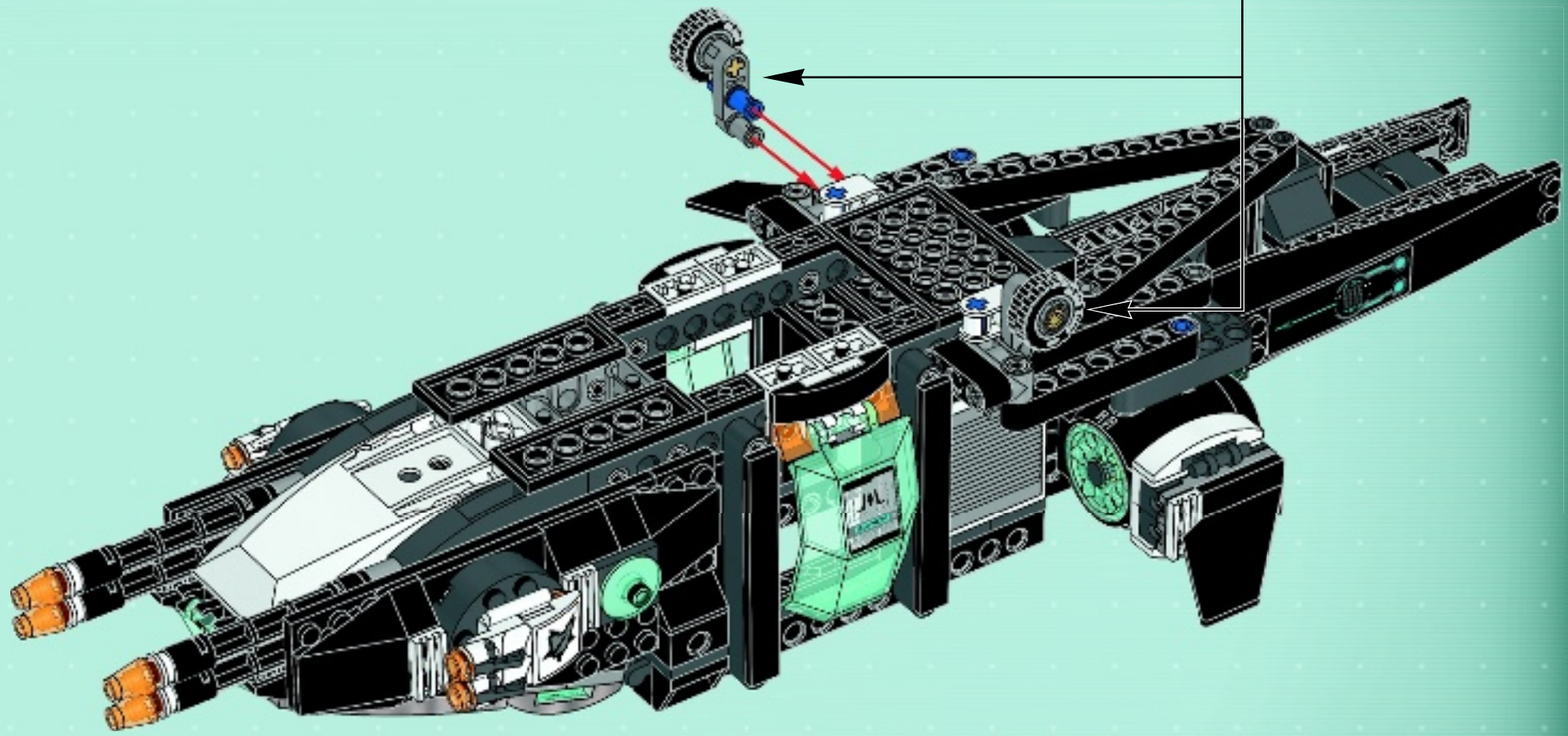
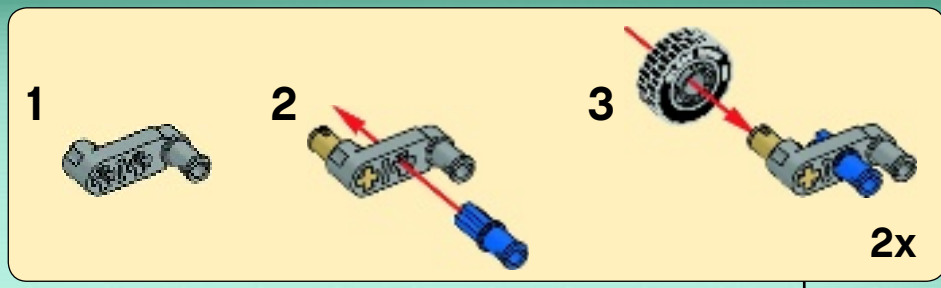



2x

2x

1x

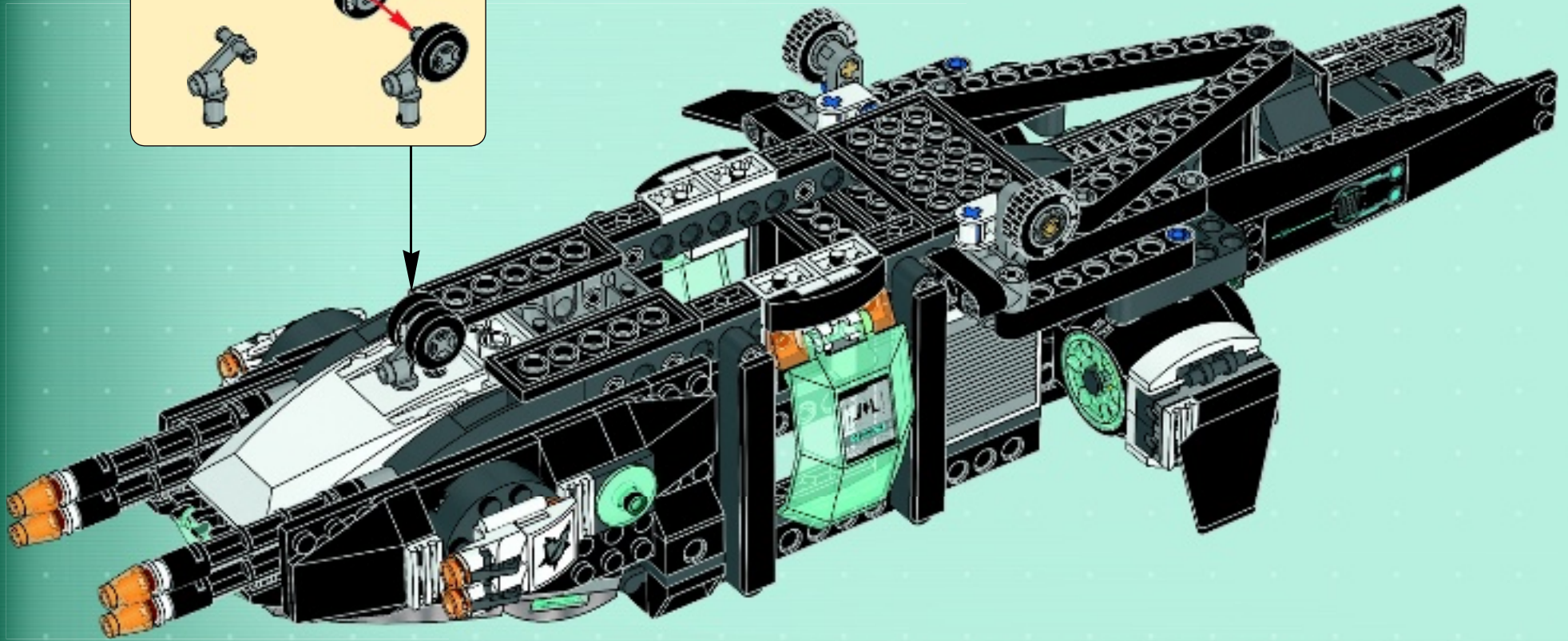
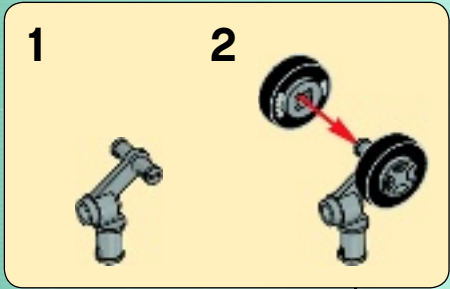
54



- 1x 
- 2x 
- 1x 

55

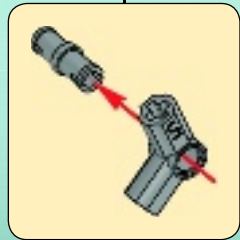
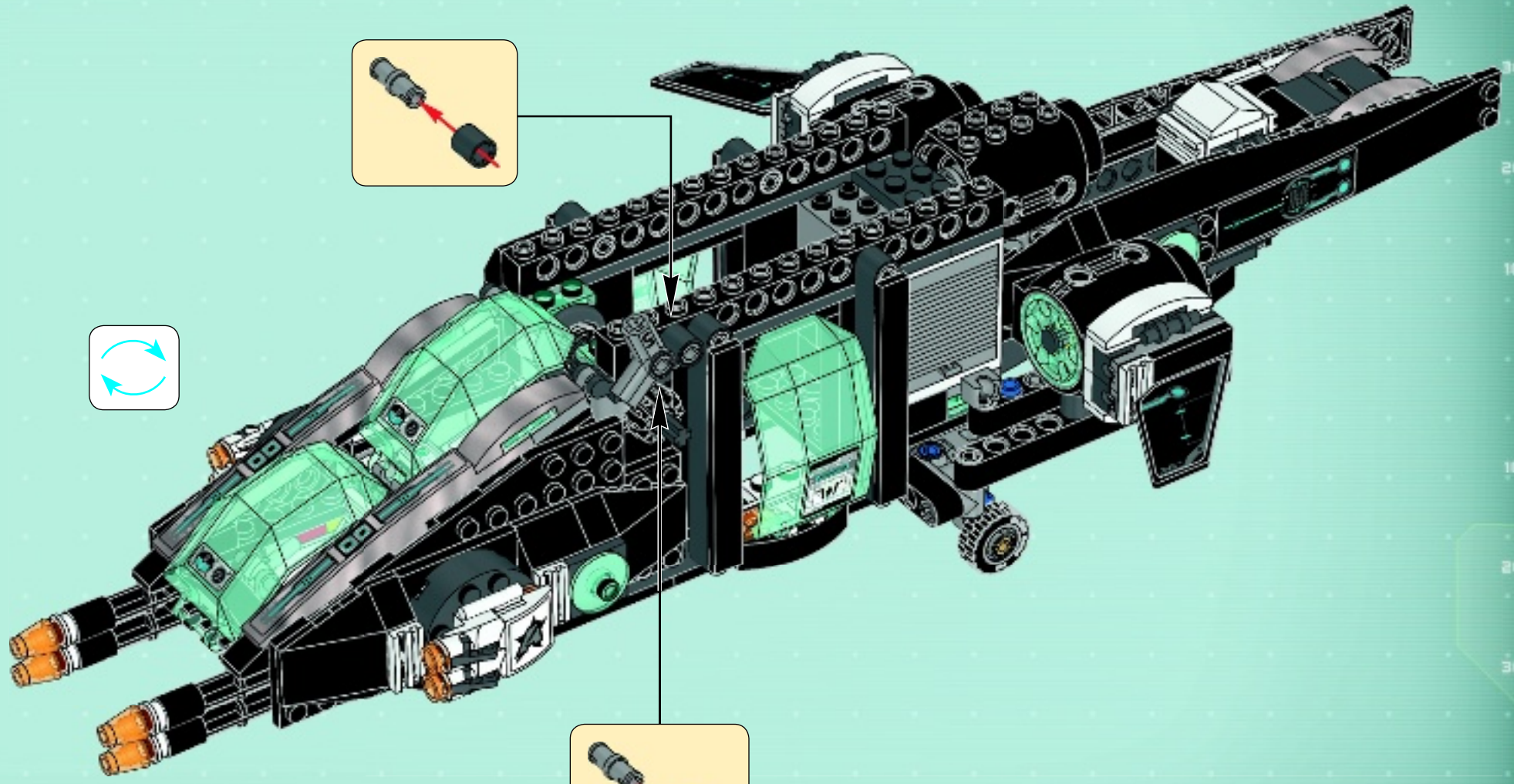
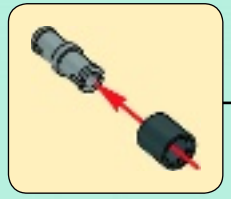
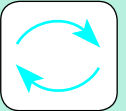

1x

1x

1x

56

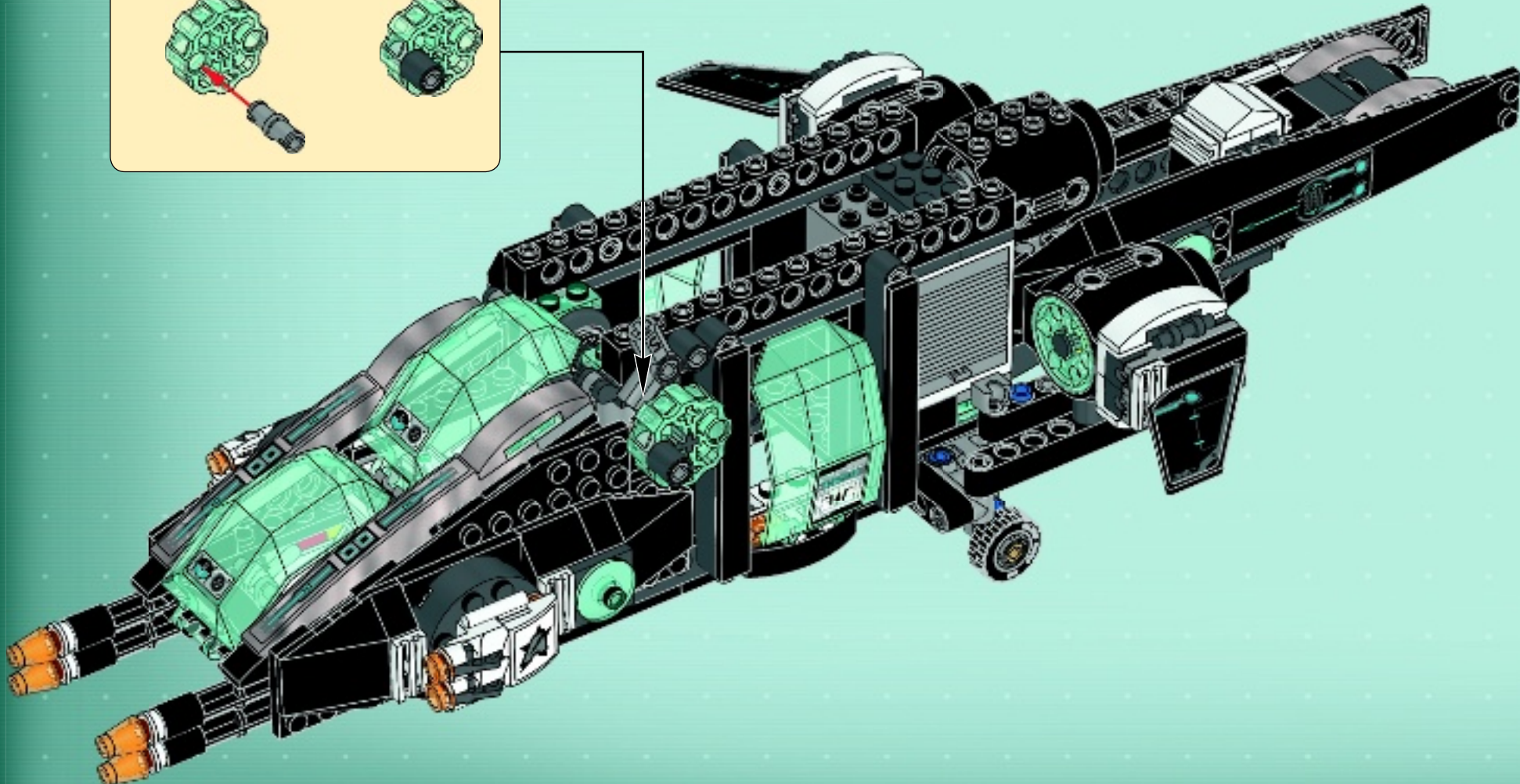
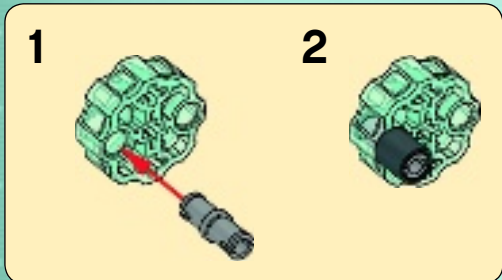

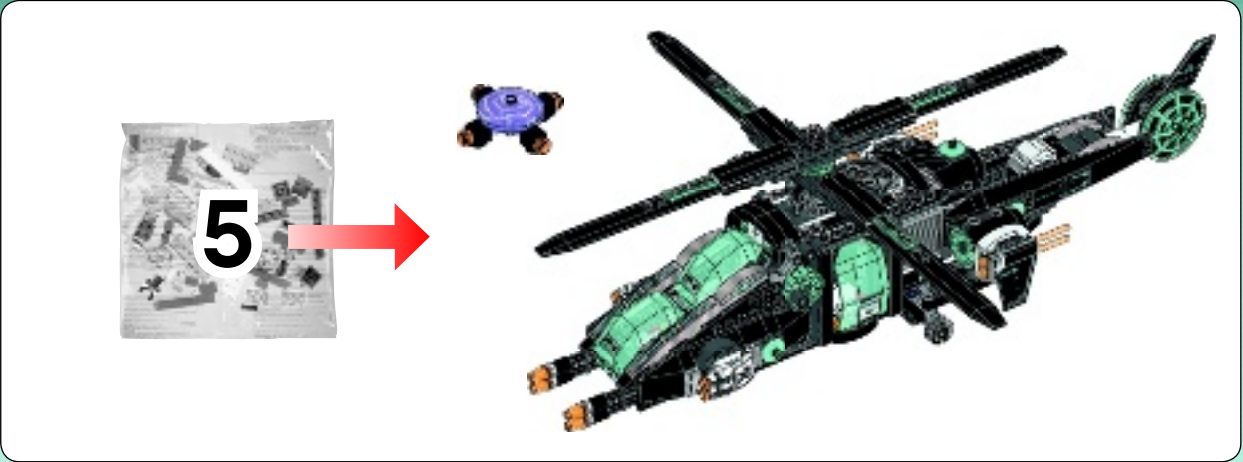

57

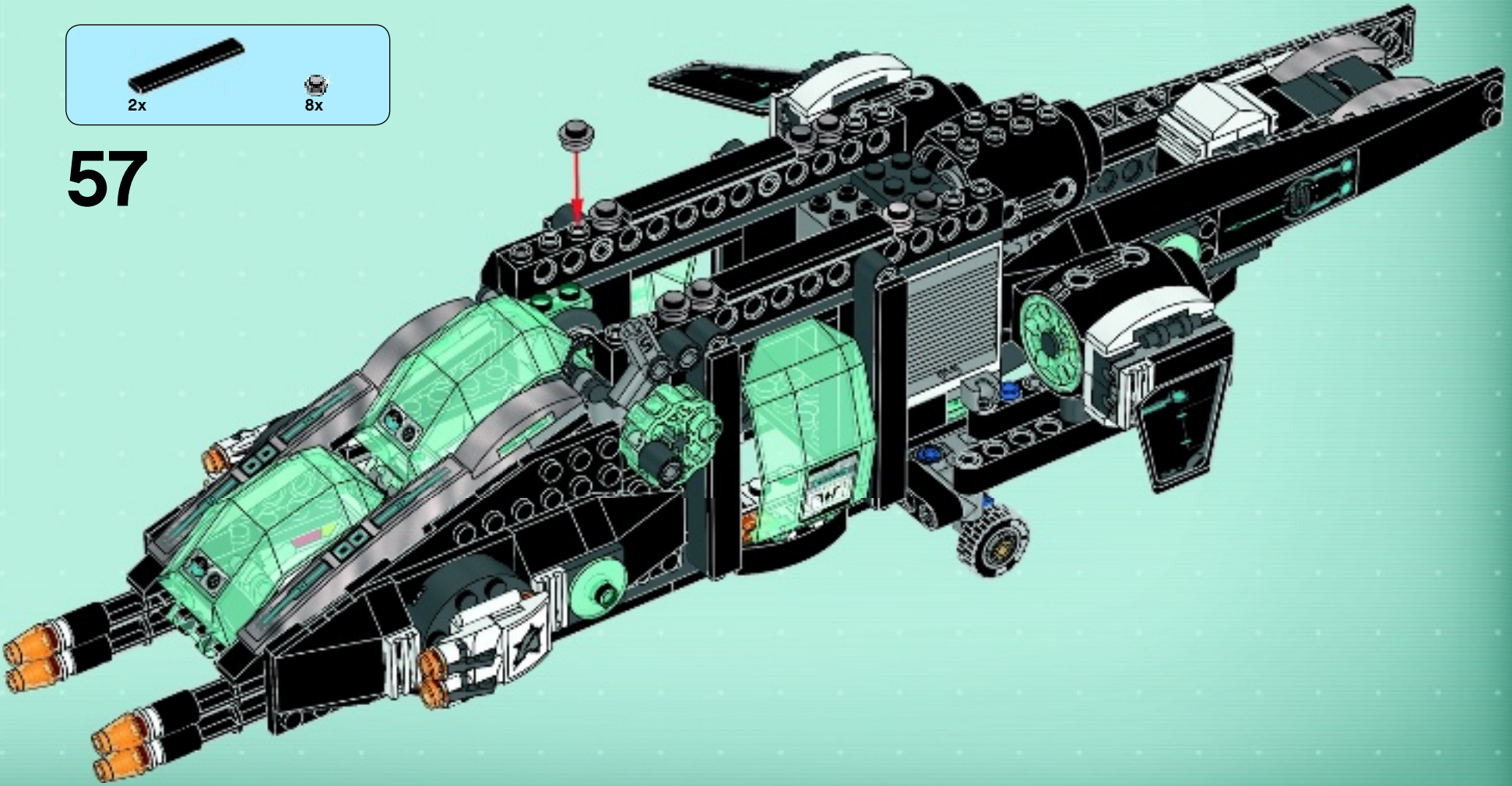

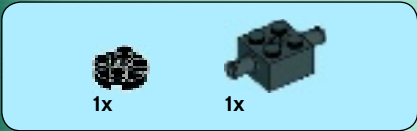

1

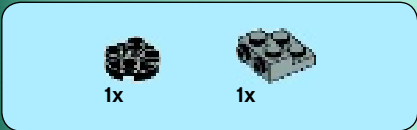

2

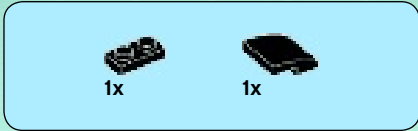
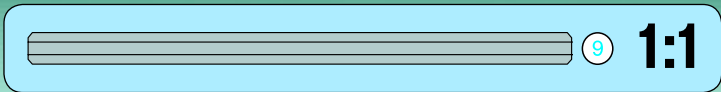

3

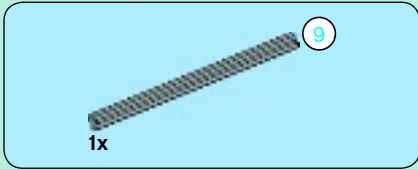
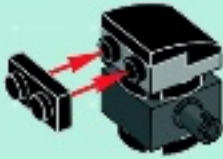

4



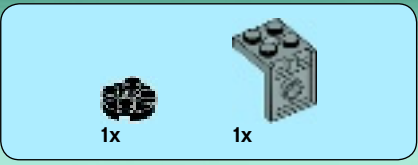

5

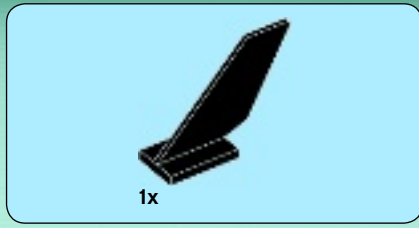
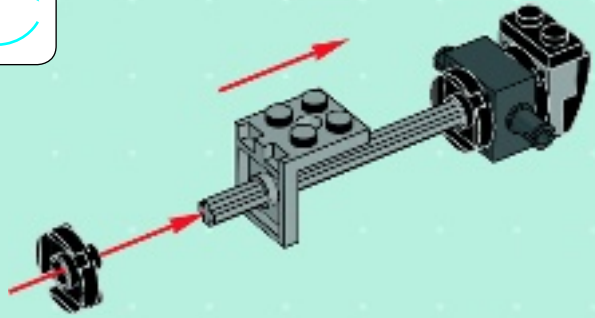
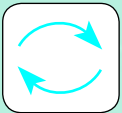

6

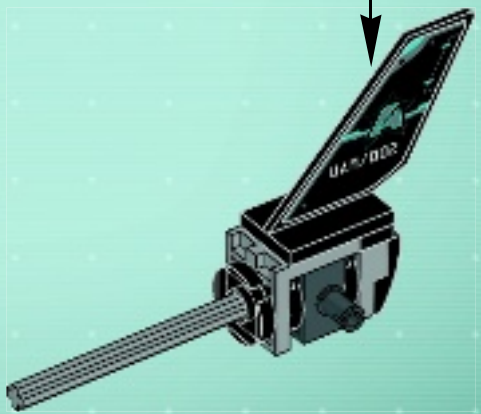
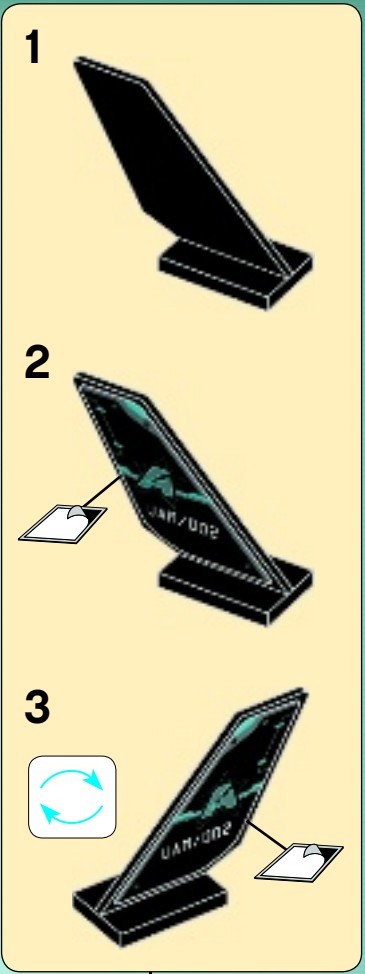



7

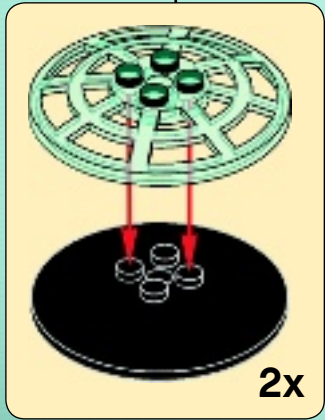
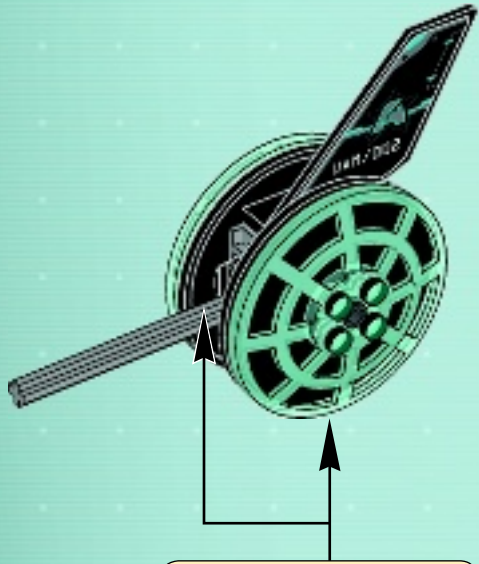

8

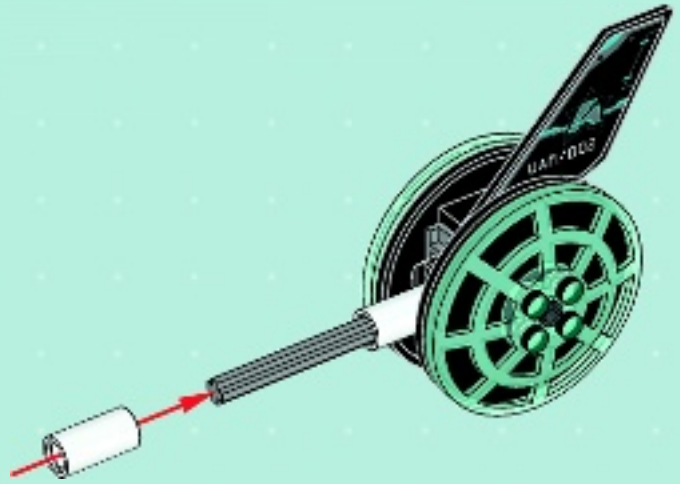

58

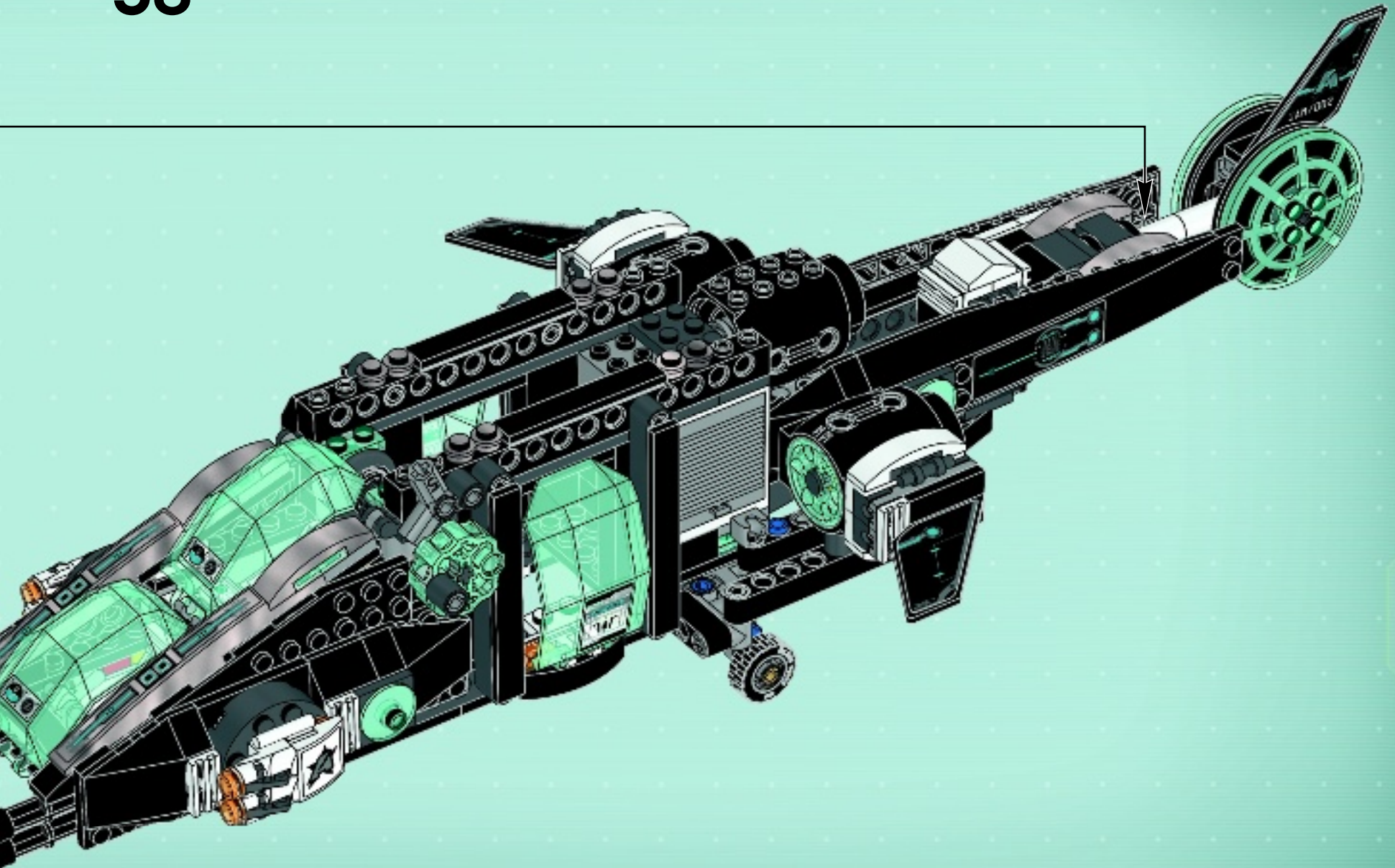

30
20
10
10
20
30

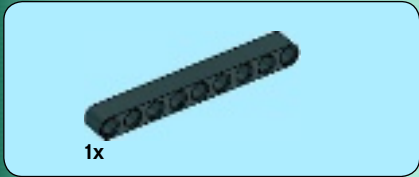
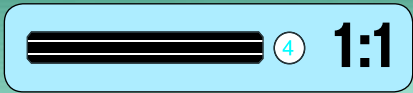
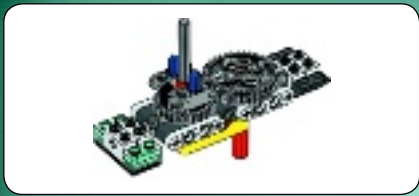

1



2

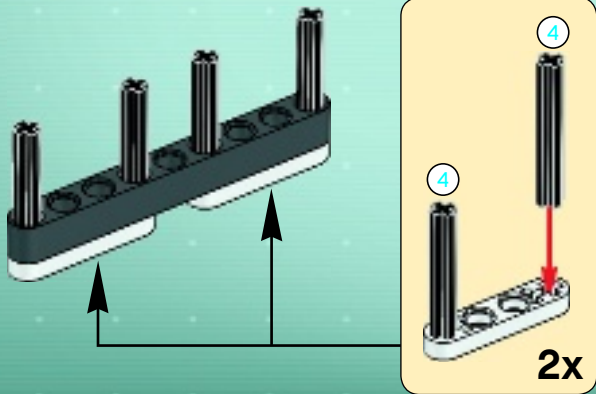

3

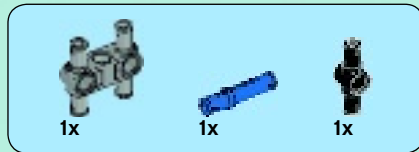
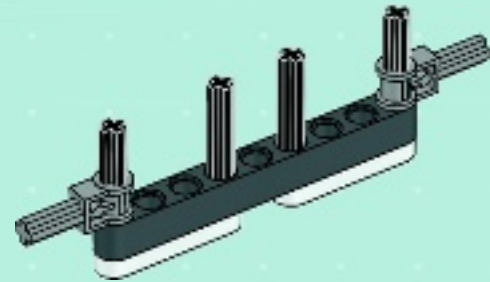

4





5

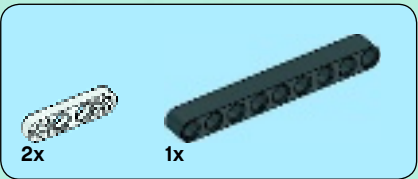
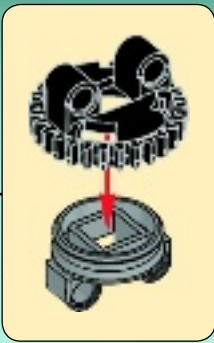
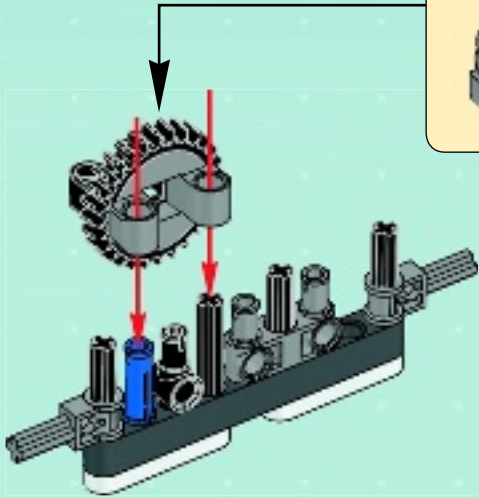

6

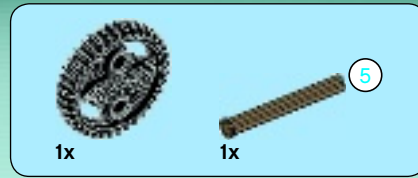
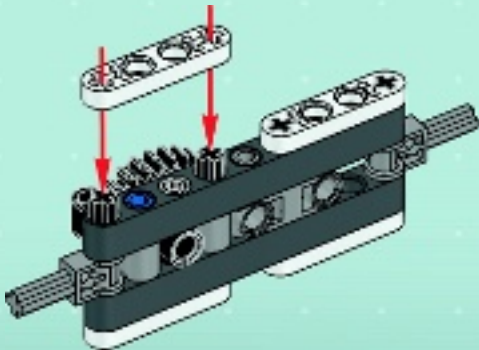

7

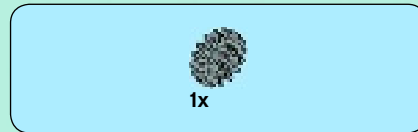
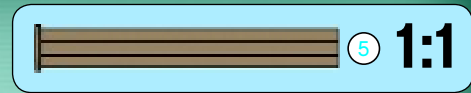
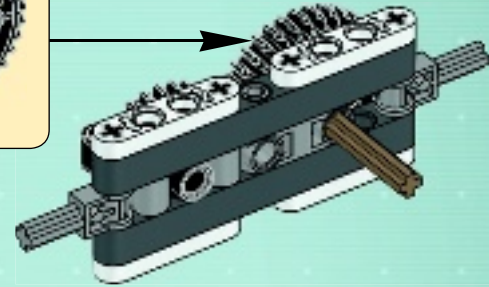
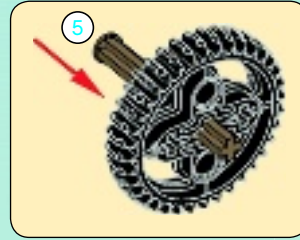

8

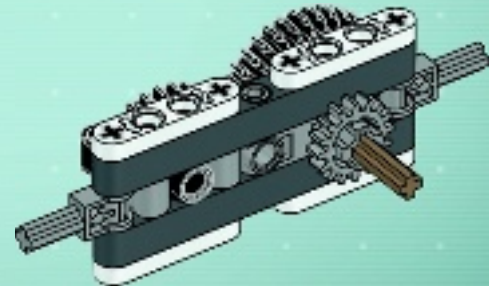

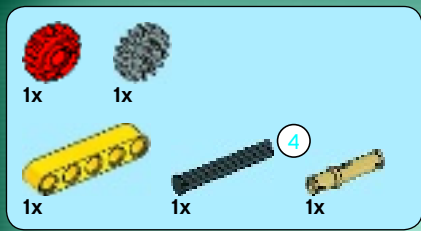

9

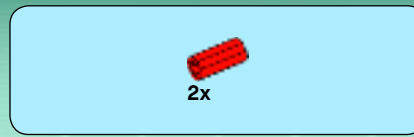
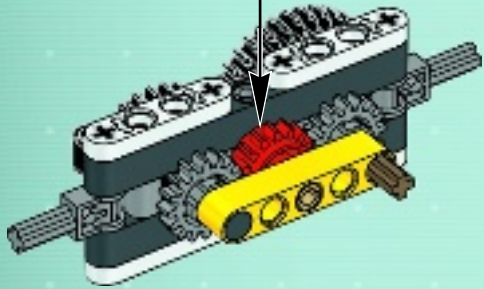
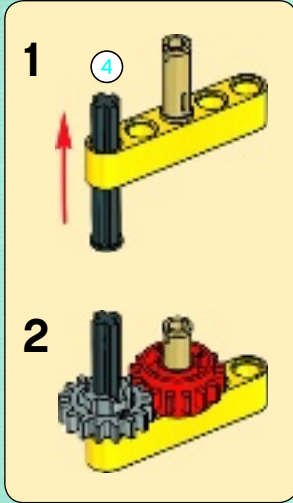

10

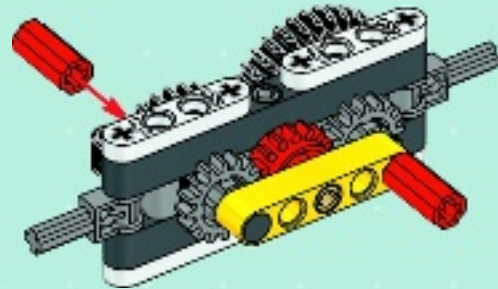



11

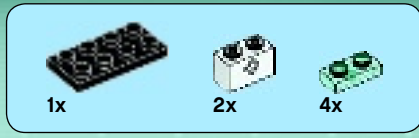
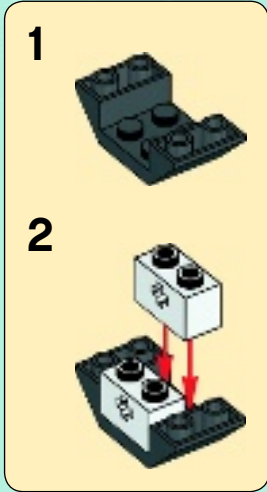

12

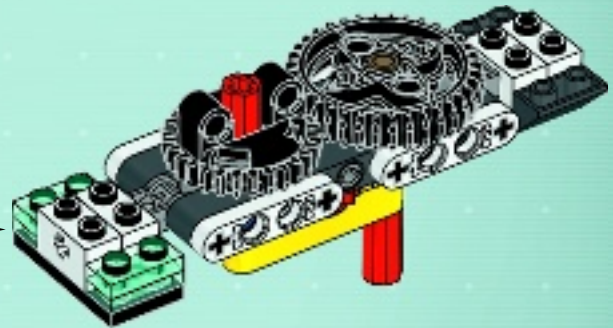
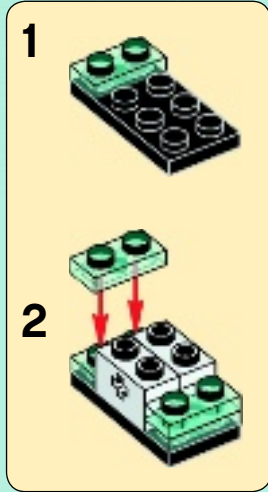

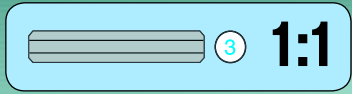
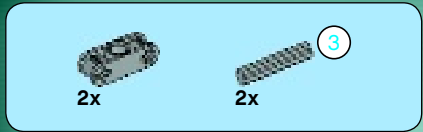

13

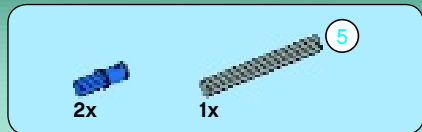
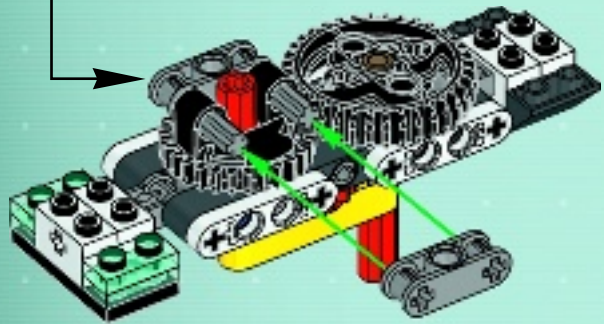
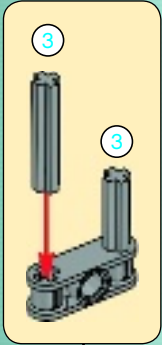

14

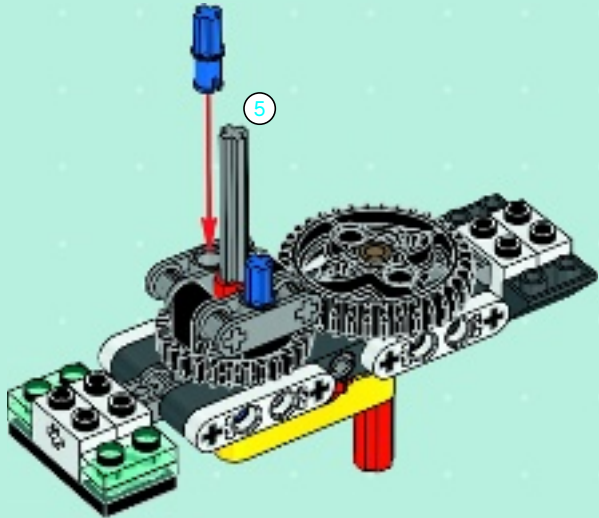

59

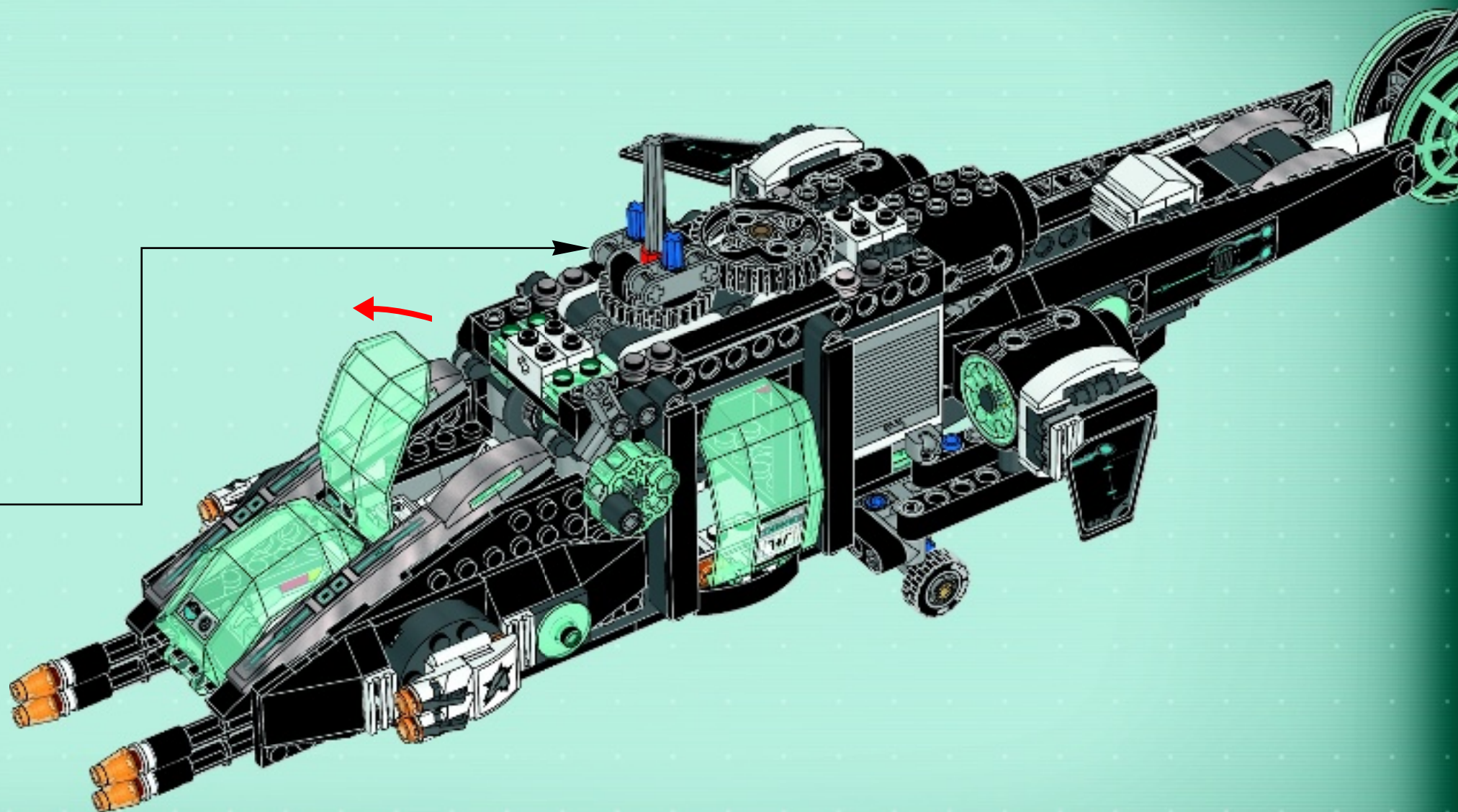



2x



1x



2x

60

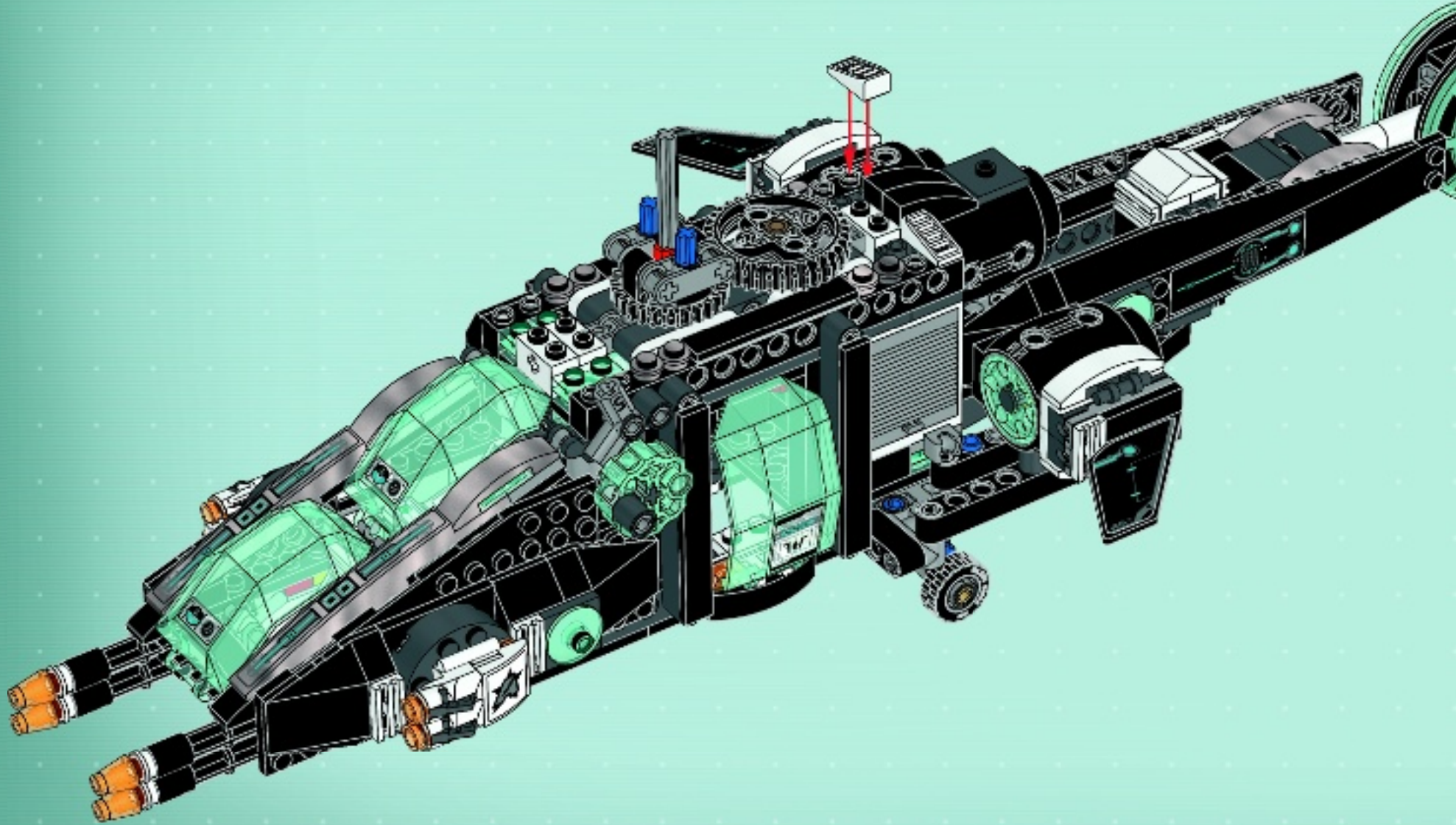



6x



1x

61

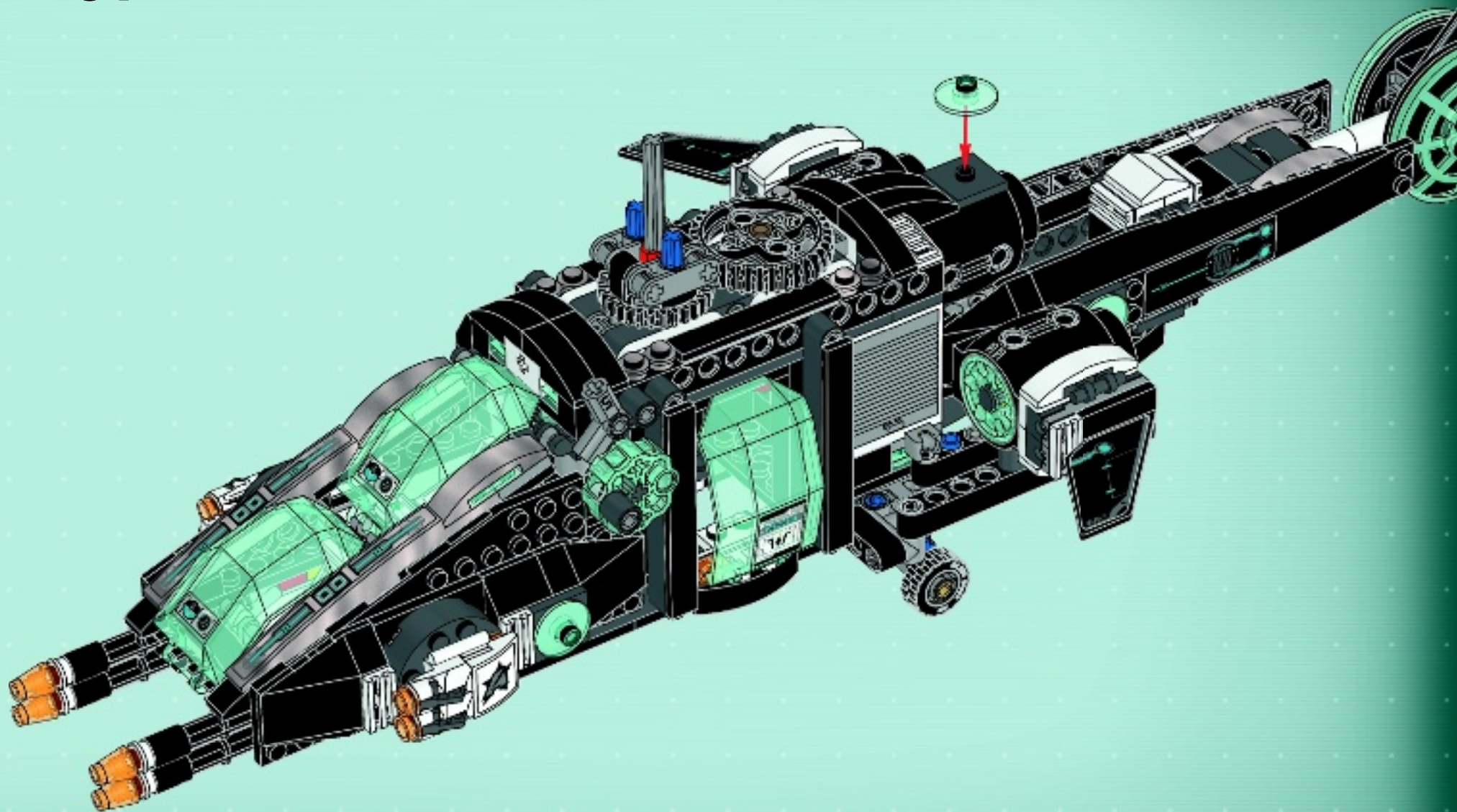

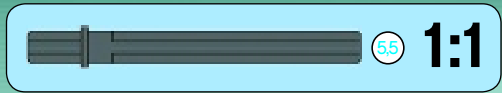
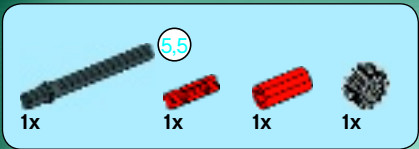

62

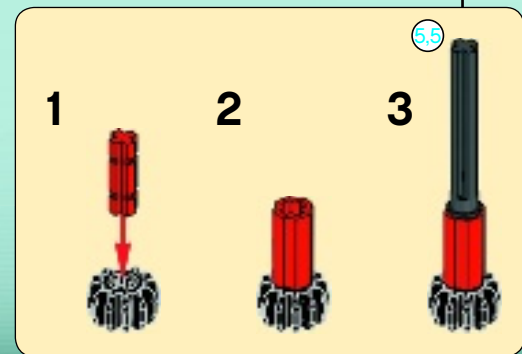
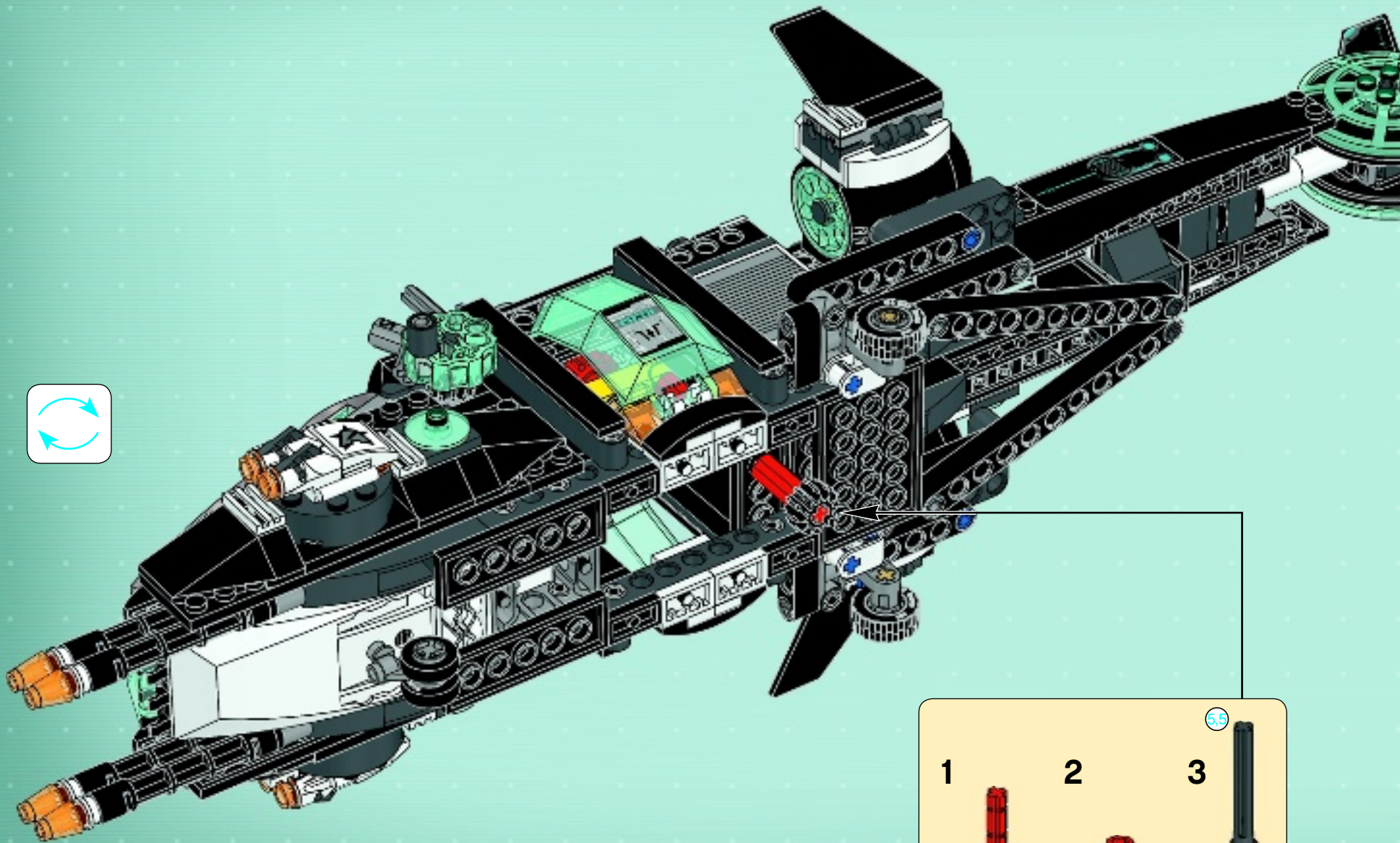

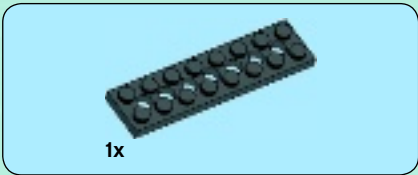

1



2

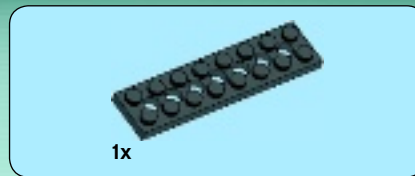

3



4

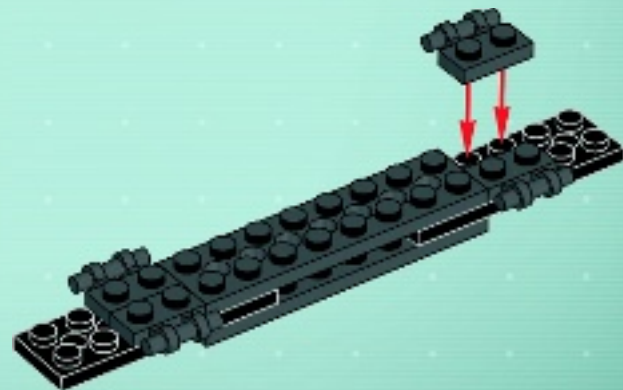

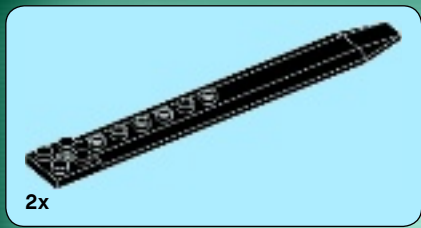

5



6

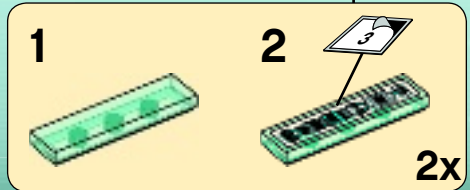
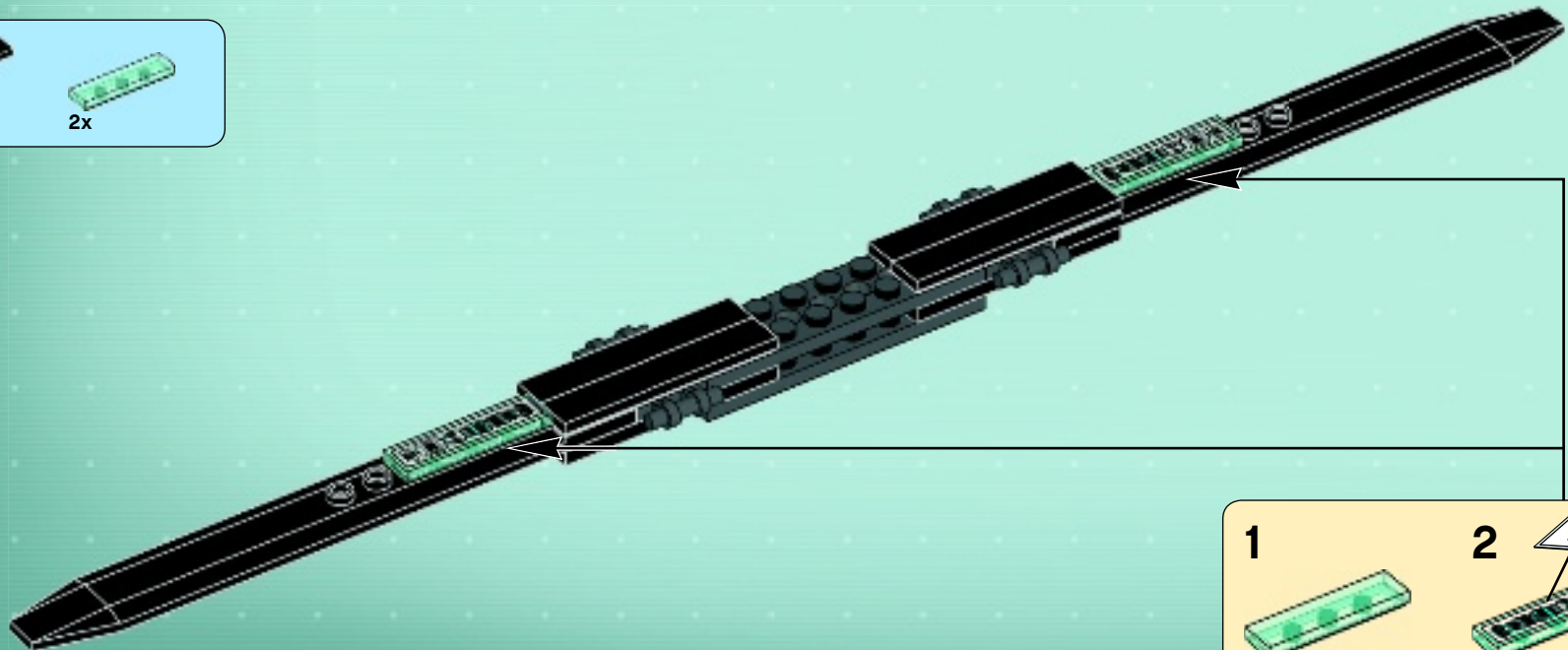

63

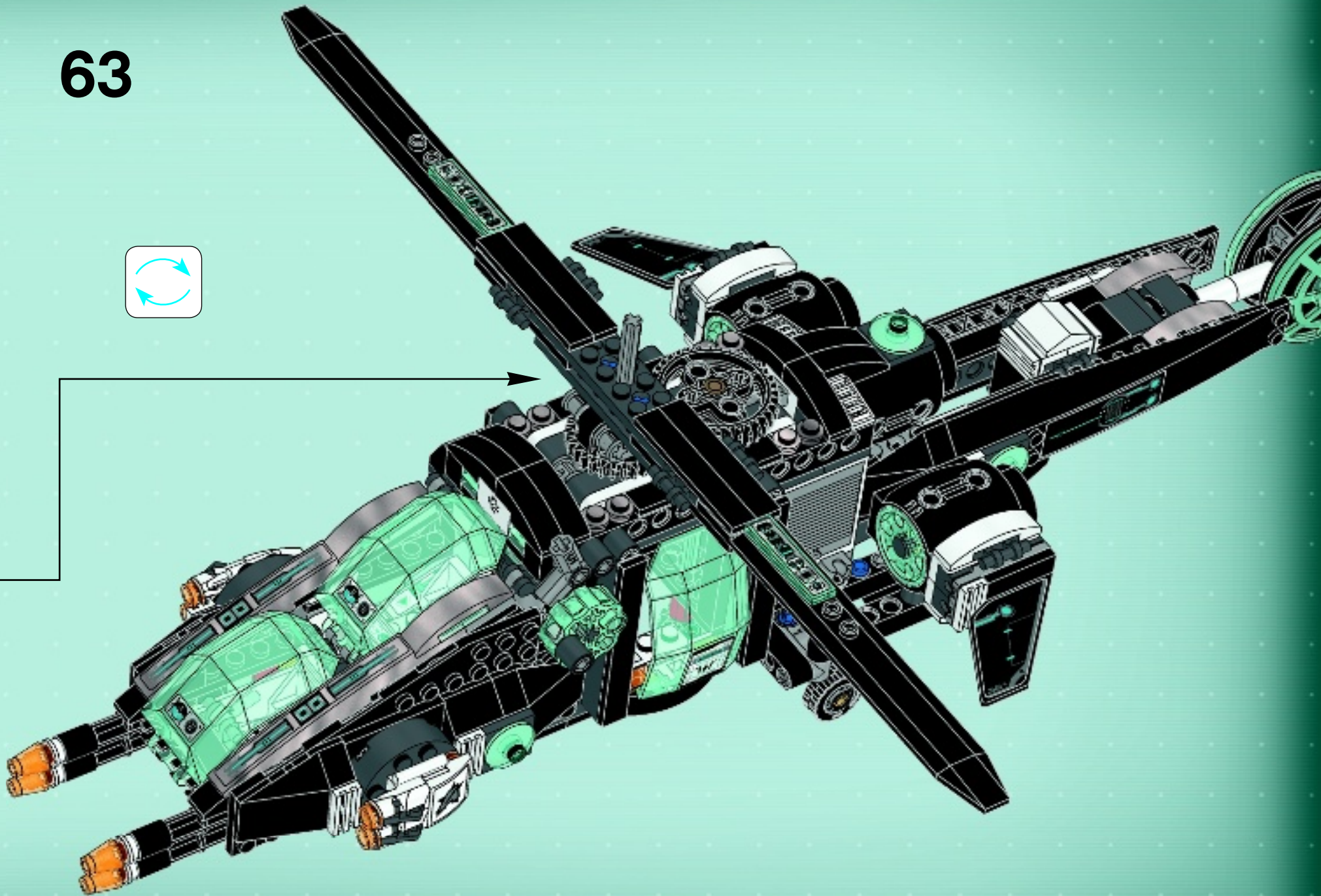
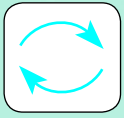



1x

64



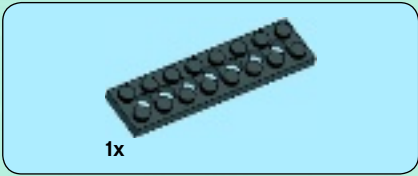
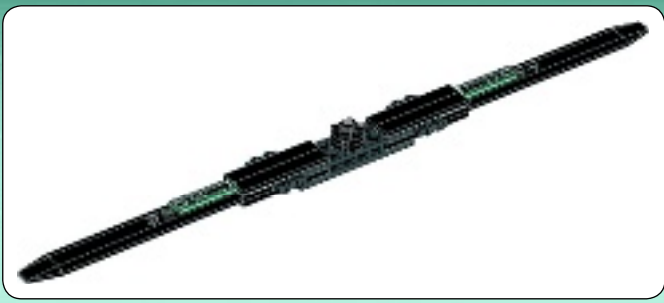

1



2

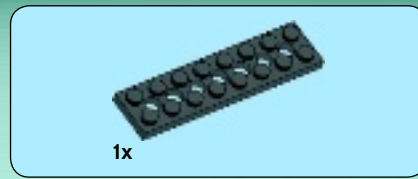

3

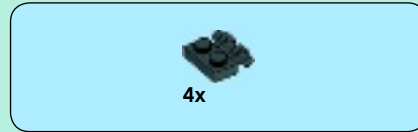

4

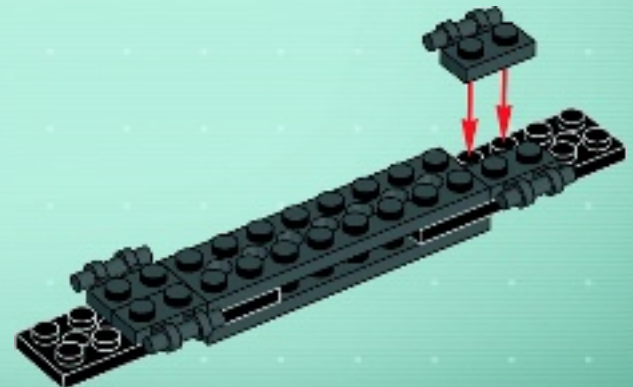

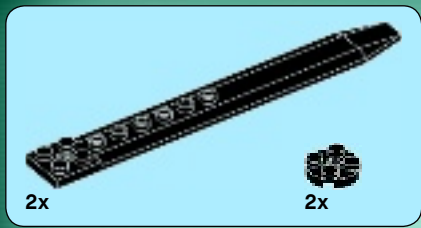

5

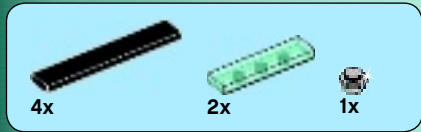
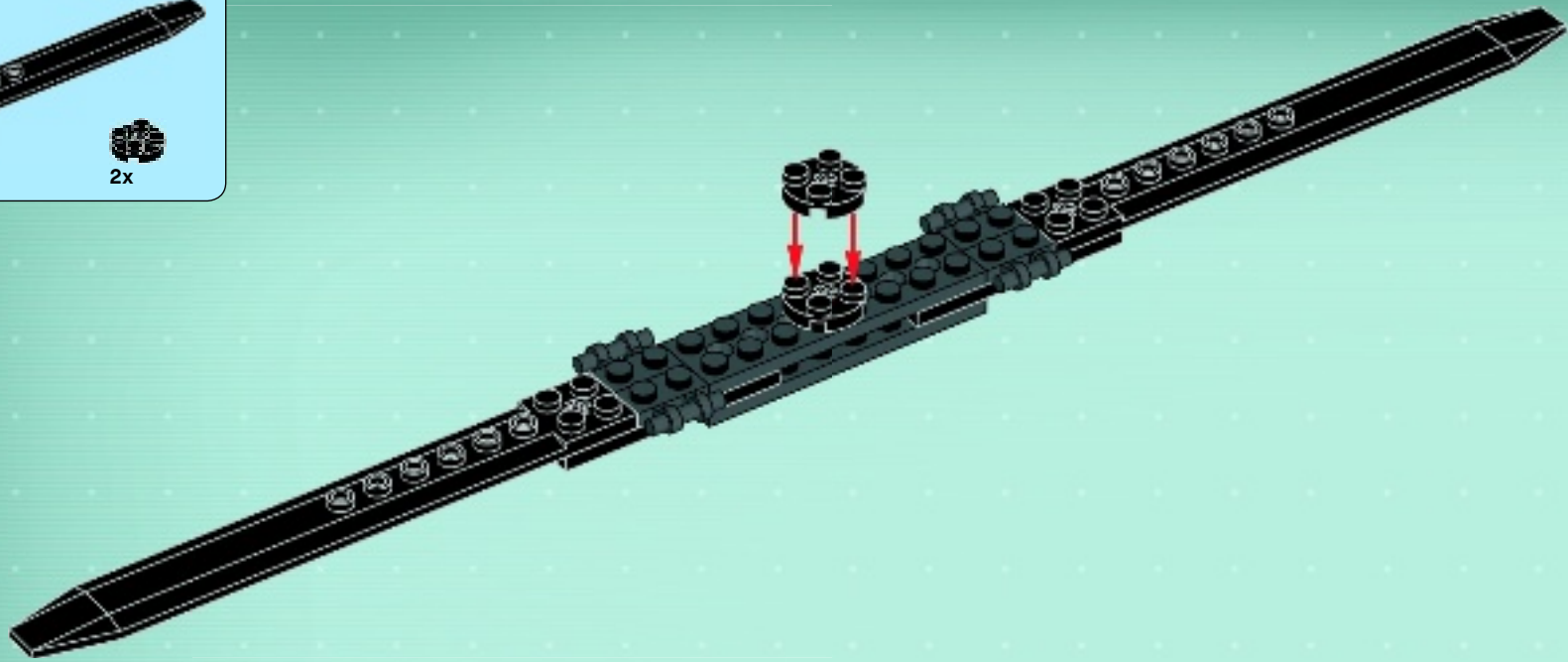

6

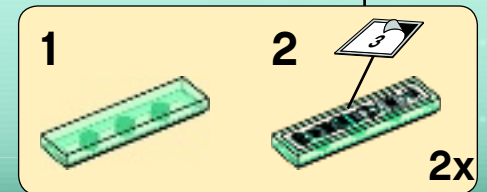
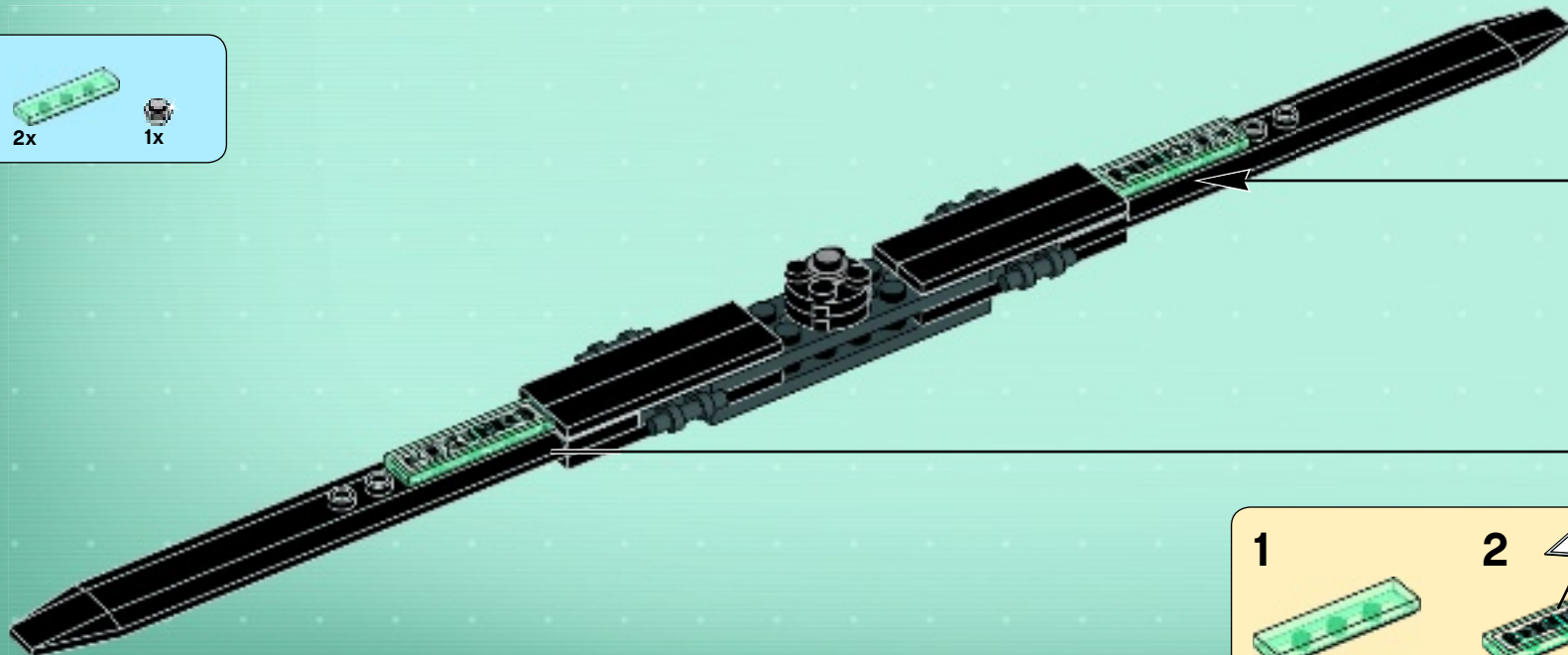

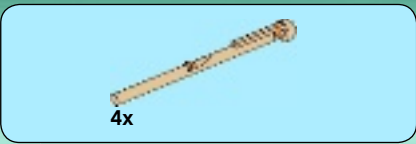

65

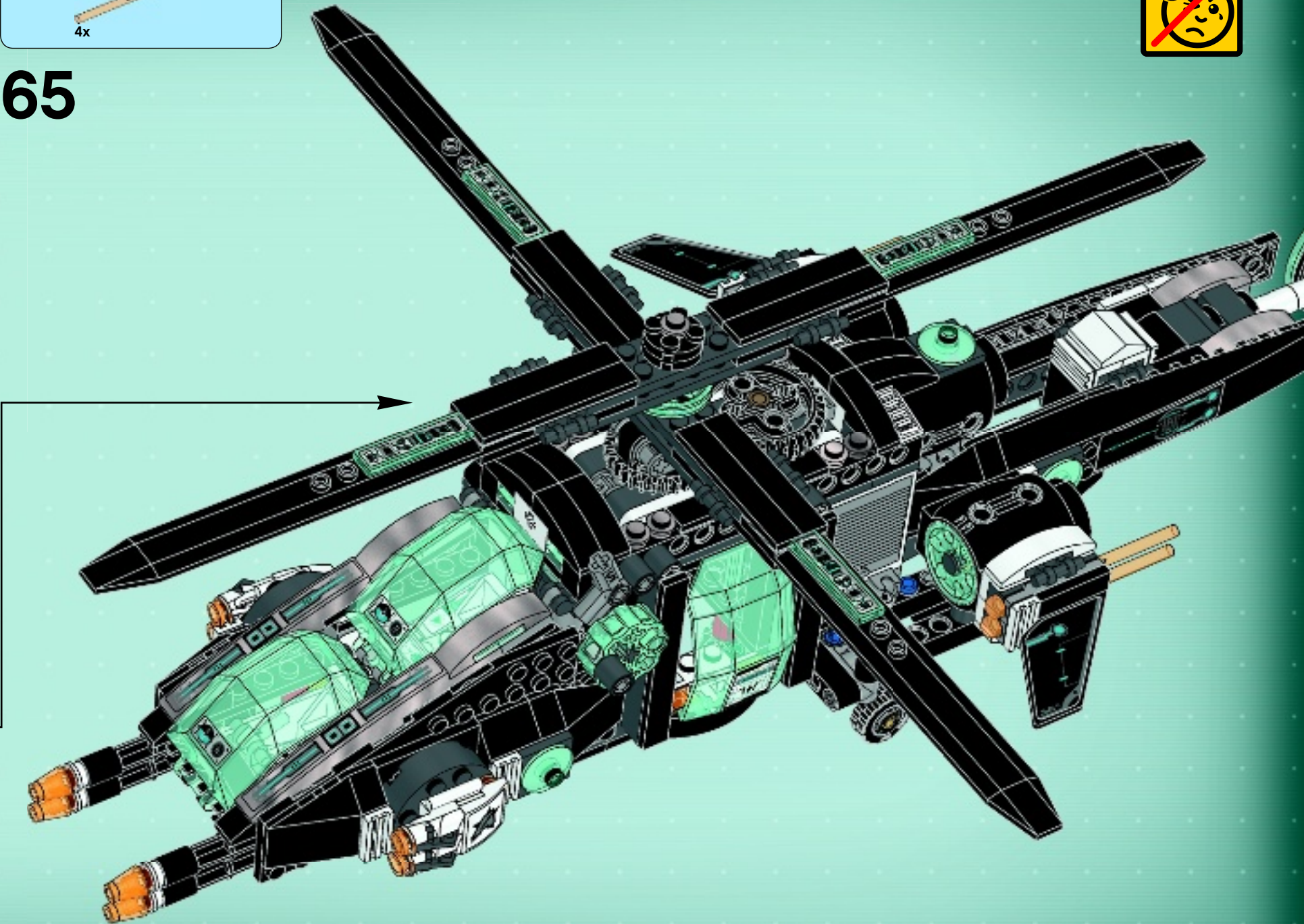



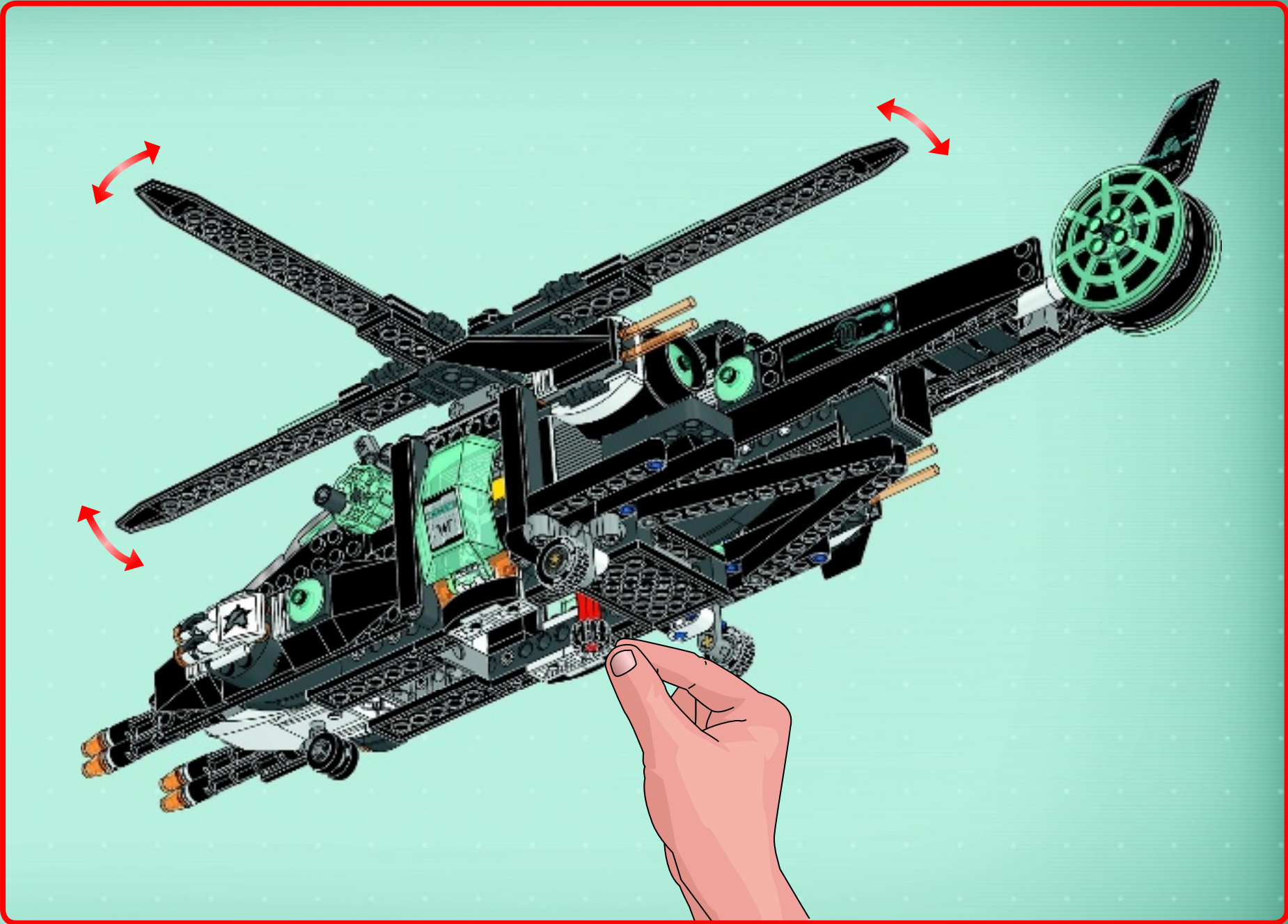



1



2



3

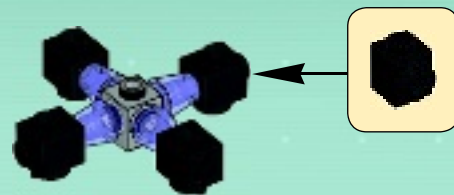

4



5



**Download the app and use the AppBrick
Gadget to complete the mission!**

**Télécharge l'appli et utilise le gadget
AppliBrique pour réussir la mission !**

**¡Descarga la app y usa el AppBrick
para completar la misión!**



Apple, the Apple logo, iPad, iPhone and iPod touch are trademarks of Apple Inc., registered in the U.S. and other countries. App Store is a service mark of Apple Inc. Apple, le logo Apple, iPad, iPhone et iPod touch sont des marques de commerce d'Apple Inc., déposées aux Etats-Unis et dans d'autres pays. App Store est une marque de service d'Apple Inc. Apple, el logotipo de Apple, iPad, iPhone e iPod touch son marcas comerciales de Apple Inc. registradas en EE. UU. y otros países. App Store es una marca de servicio de Apple Inc. Google Play is a trademark of Google Inc. Google Play est une marque de commerce de Google Inc. Google Play es una marca comercial de Google Inc.

Unlock the secrets with the new AppBrick Gadgets

Découvre les secrets avec les nouveaux gadgets AppliBrique

Descubre los secretos con los nuevos AppBricks





ULTRA AGENTS



70168



70169



70166



70167



70170



42037

42038





42039

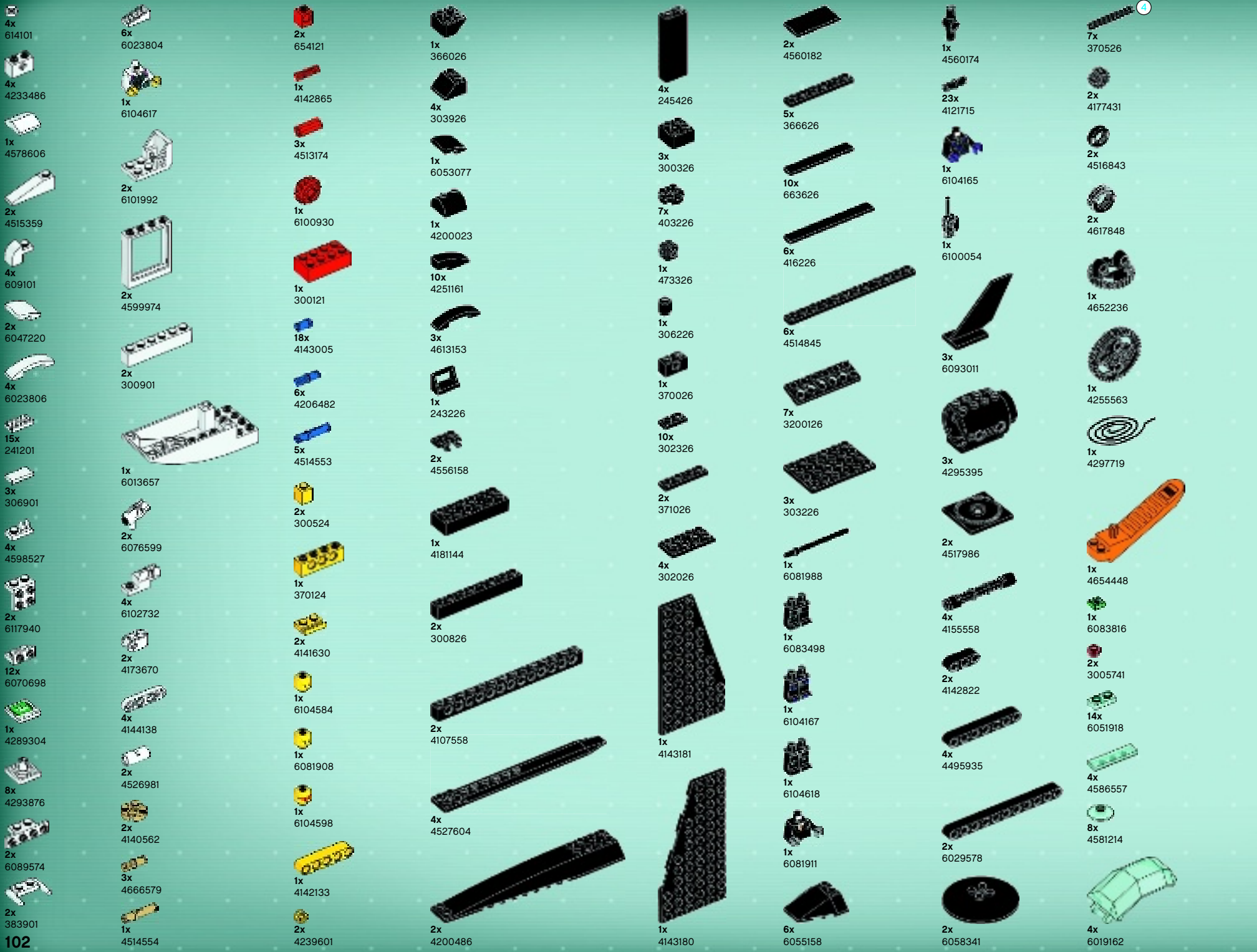

4x 614101
 4x 4233486
 1x 4578606
 2x 4515359
 4x 609101
 2x 6047220
 4x 6023806
 15x 241201
 3x 306901
 4x 4598527
 2x 6117940
 12x 6070698
 1x 4289304
 8x 4293876
 2x 6089574
 2x 383901
102

6x 6023804
 1x 6104617
 2x 6101992
 2x 4599974
 2x 300901
 1x 6013657
 2x 6076599
 4x 6102732
 2x 4173670
 4x 4144138
 2x 4526981
 2x 4140562
 3x 4666579
 1x 4514554

2x 654121
 1x 4142865
 3x 4513174
 1x 6100930
 1x 300121
 18x 4143005
 6x 4206482
 5x 4514553
 2x 300524
 1x 370124
 2x 4141630
 1x 6104584
 1x 6081908
 1x 6104598
 1x 4142133
 2x 4239601

1x 366026
 4x 303926
 1x 6053077
 1x 4200023
 10x 4251161
 3x 4613153
 1x 243226
 2x 4556158
 1x 4181144
 2x 300826
 2x 4107558
 4x 4527604
 2x 4200486

4x 245426
 3x 300326
 7x 403226
 1x 473326
 1x 306226
 1x 370026
 10x 302326
 2x 371026
 4x 302026
 1x 4143181
 1x 4143180

2x 4560182
 5x 366626
 10x 663626
 6x 416226
 6x 4514845
 7x 3200126
 3x 303226
 1x 6081988
 1x 6083498
 1x 6104167
 1x 6104618
 1x 6081911
 6x 6055158

1x 4560174
 23x 4121715
 1x 6104165
 1x 6100054
 3x 6093011
 3x 4295395
 2x 4517986
 4x 4155558
 2x 4142822
 4x 4495935
 2x 6029578
 2x 6058341

7x 370526
 2x 4177431
 2x 4516843
 2x 4617848
 1x 4652236
 1x 4255563
 1x 4297719
 1x 4654448
 1x 6083816
 2x 3005741
 14x 6051918
 4x 4586557
 8x 4581214
 4x 6019162



GO TO WWW.LEGO.COM/PRODUCTFEEDBACK AND GIVE US YOUR SHORT **FEEDBACK** ABOUT THIS LEGO® SET FOR A CHANCE TO WIN A COOL LEGO PRIZE.

LEGO.com/productfeedback

GEWINNE



Erzähle uns auf www.LEGO.com/productfeedback

etwas über die Erfahrungen, die du mit diesem LEGO® Set gemacht hast, und sichere dir die Chance auf einen coolen LEGO Preis!

GAGNE



Rends-toi sur www.LEGO.com/productfeedback

et donne-nous quelques commentaires sur ce produit LEGO® pour avoir une chance de gagner un prix LEGO !

GANAN



Visita www.LEGO.com/productfeedback

y envíanos tu opinión acerca de este set LEGO®. ¡Participarás en el sorteo de un premio LEGO!

获取奖品



登录 www.LEGO.com/productfeedback

给出关于此乐高®套装的简短反馈，就有机会获得炫酷乐高奖品

경품 당첨 기회



www.LEGO.com/productfeedback

페이지로 이동하여 이 레고® 세트에 대한 간략한 피드백을 보내 주시고 멋진 레고 경품을 탈 수 있는 기회도 잡으십시오

ЗАПОЛНИ АНКЕТУ И ПОЛУЧИ ПРИЗ



Перейди по ссылке www.LEGO.com/productfeedback

ответь всего на несколько вопросов об этом наборе LEGO®, и у тебя появится шанс выиграть замечательный приз от компании LEGO.