



# CITY

60132



 [LEGO.com/city](https://www.lego.com/city)



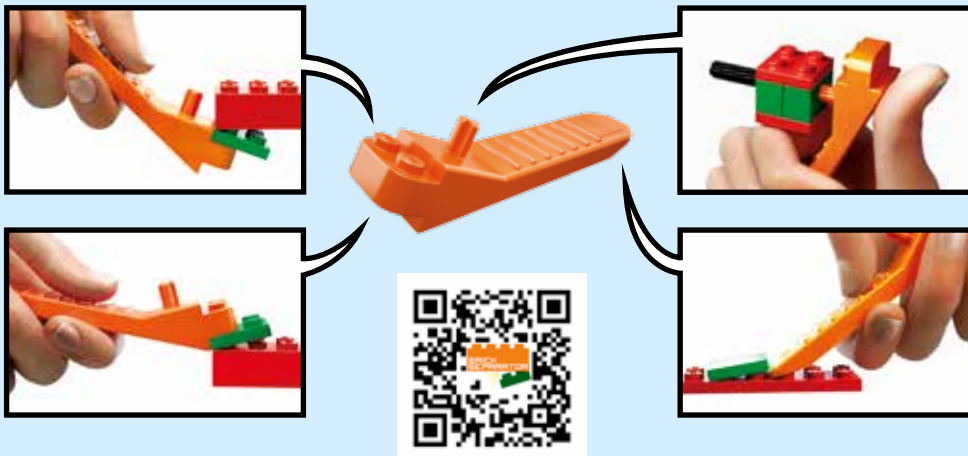

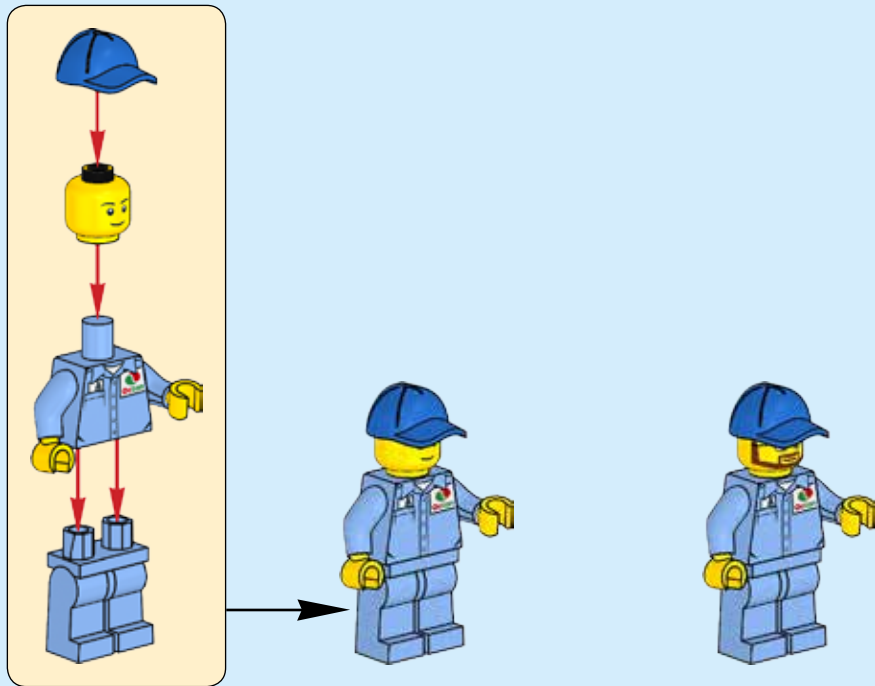

1



2

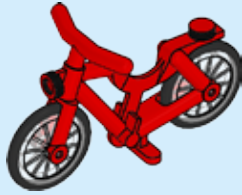

3

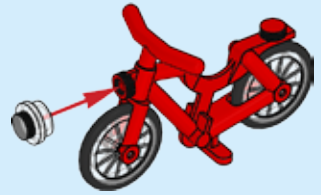



1x

**1**

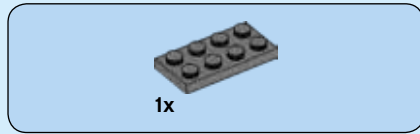

1x

**2**

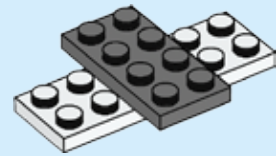



2x



2x

3

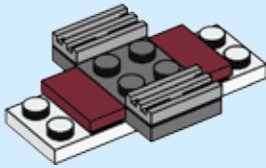

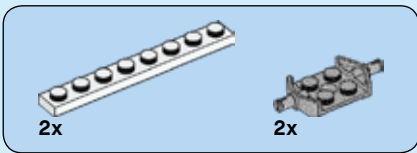

4

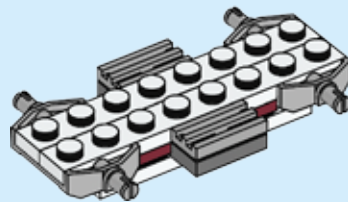
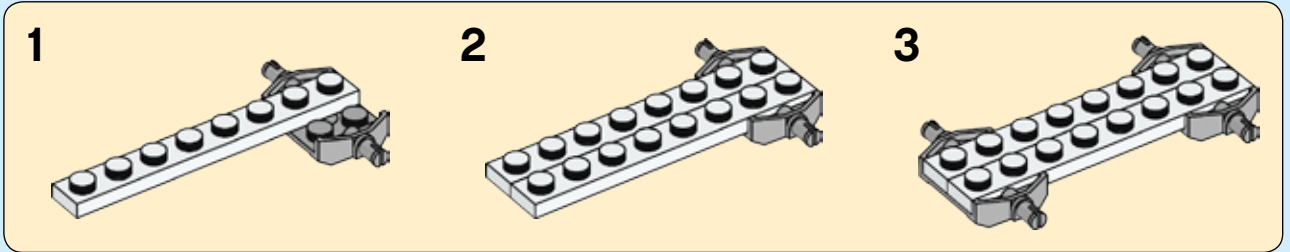



1x



1x

5

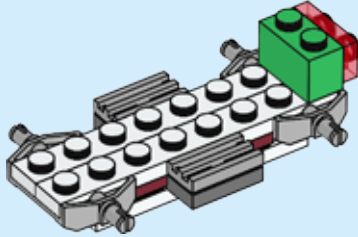
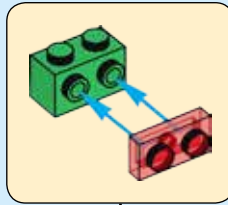





6

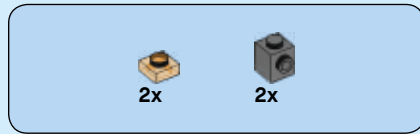
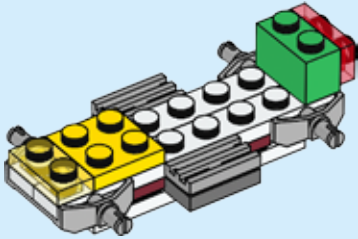

7

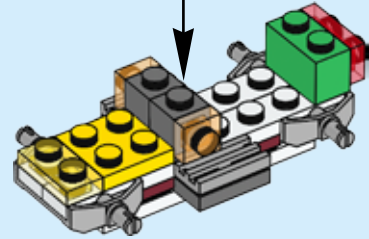
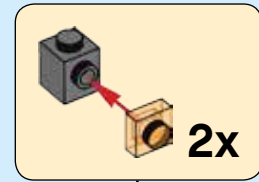



1x



1x

# 8

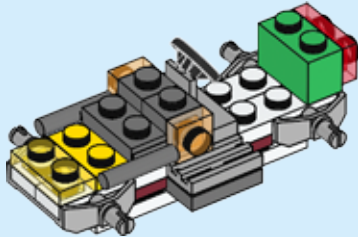

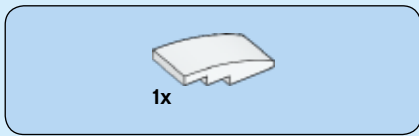

9

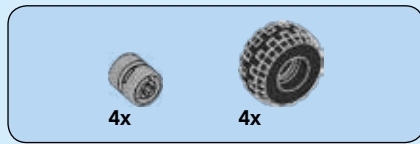
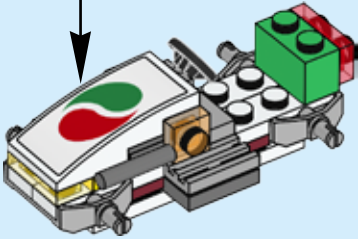
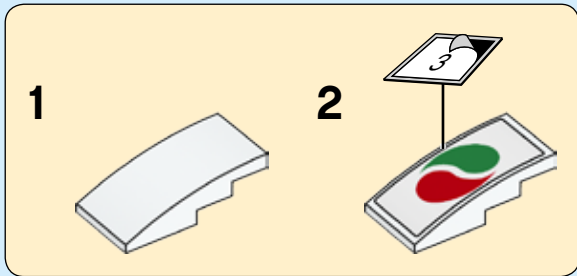

10

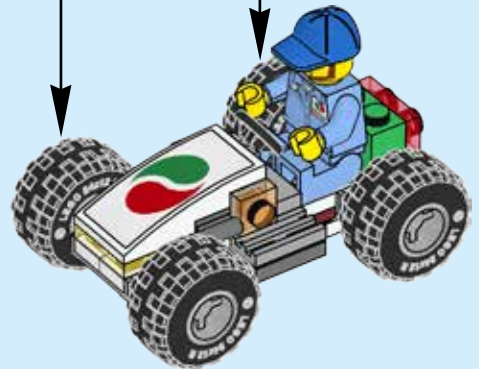
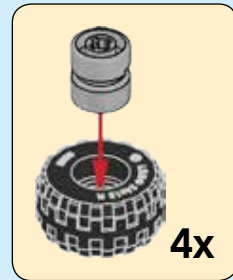

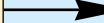
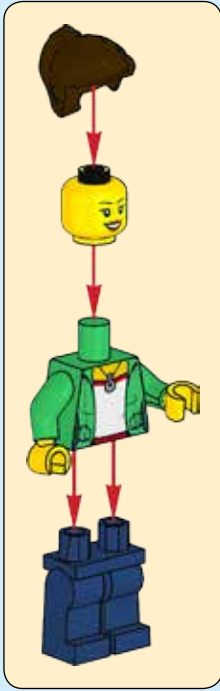

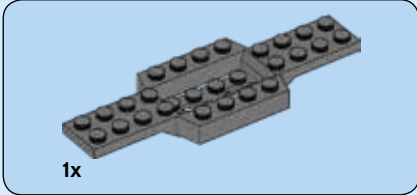

1

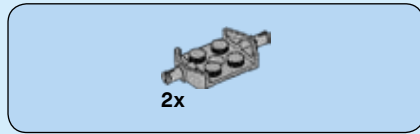
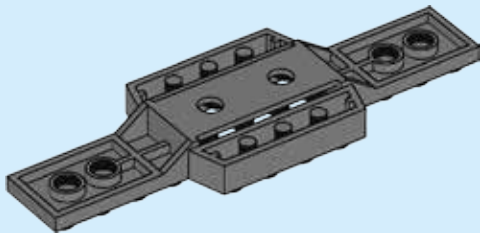

2

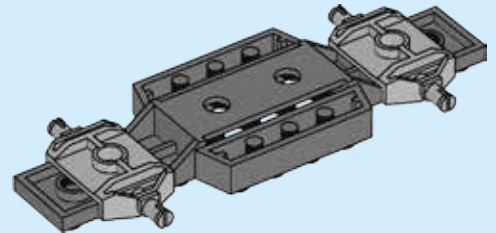



2x

3

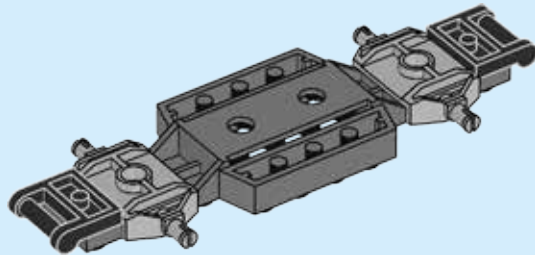



# 4

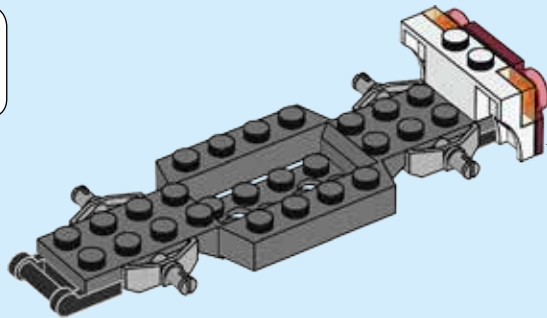
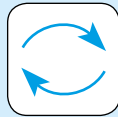
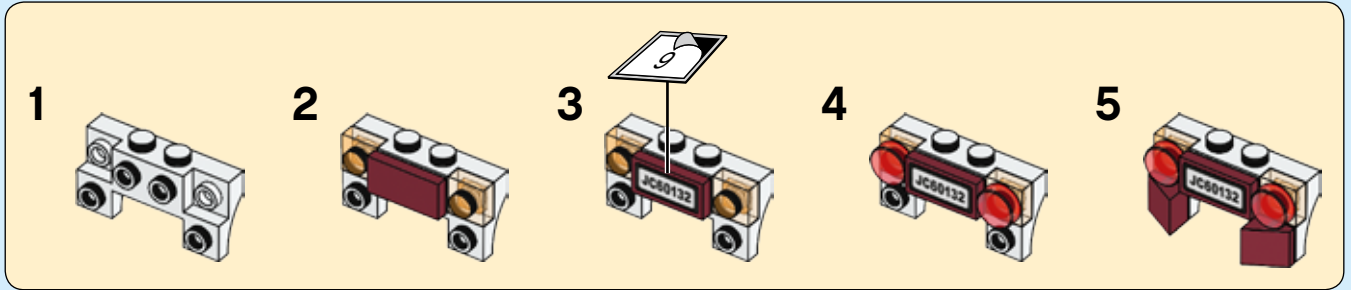

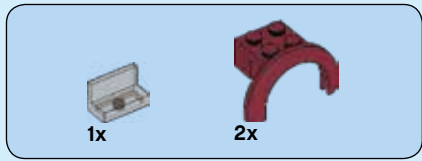

5

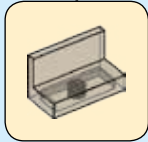
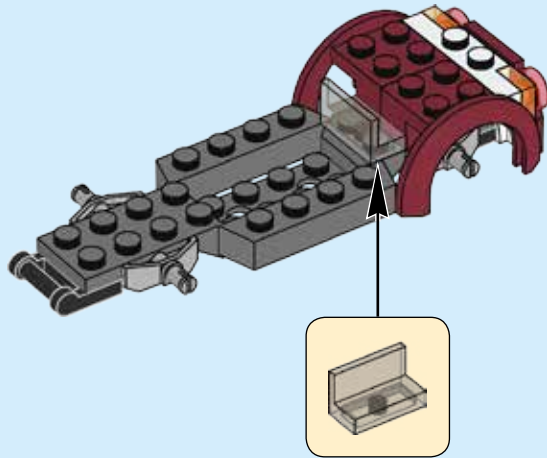





1x



1x

# 6

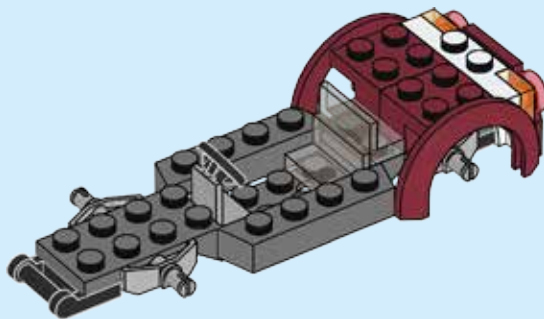

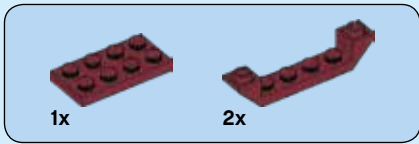

7

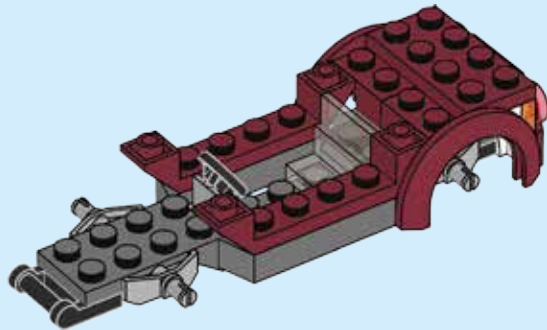



8

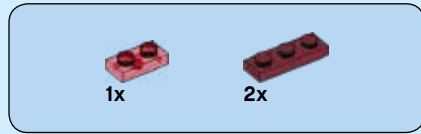
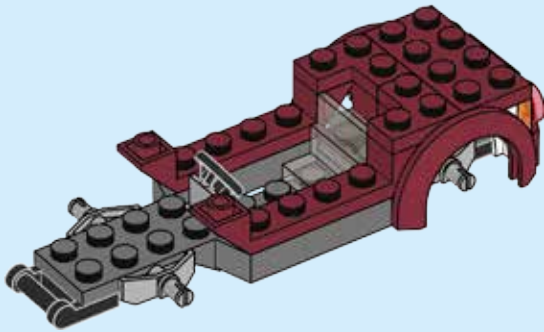

9

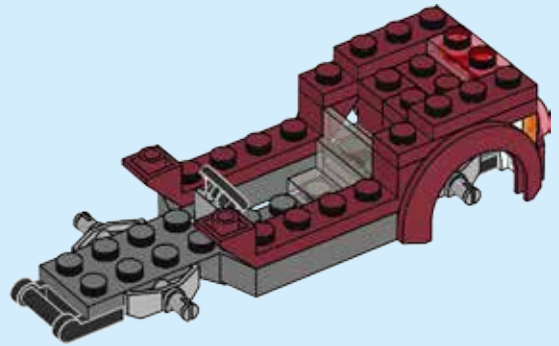



1x



1x

# 10

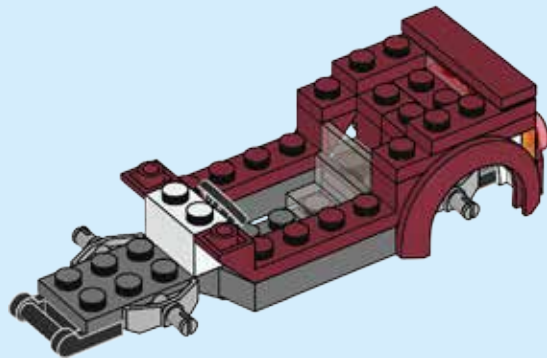

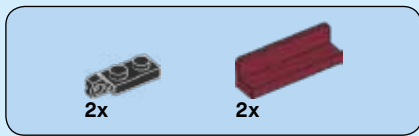

# 11

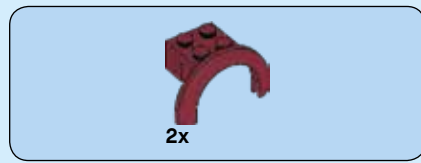
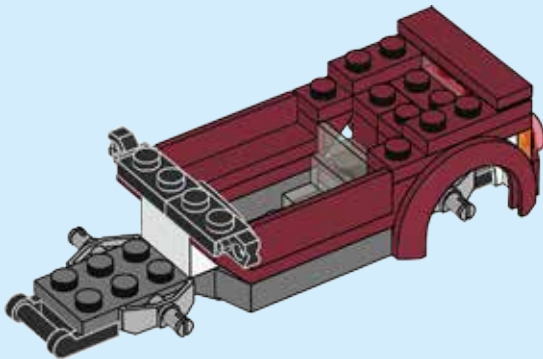

# 12

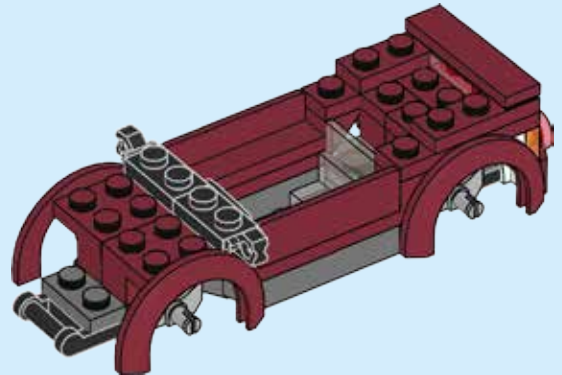

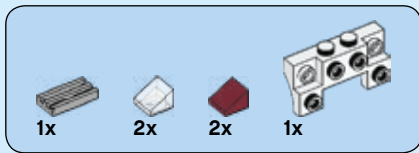

# 13

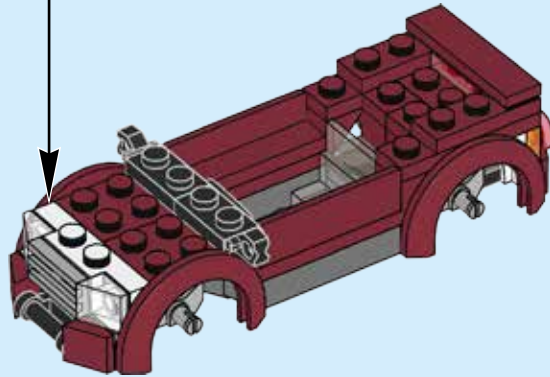
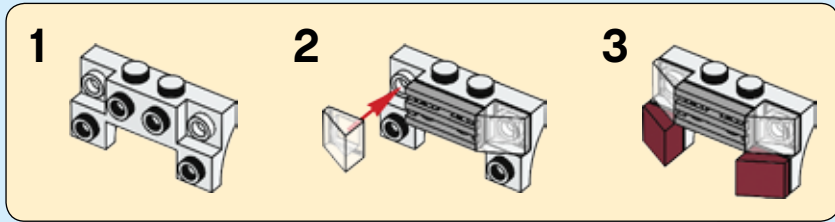

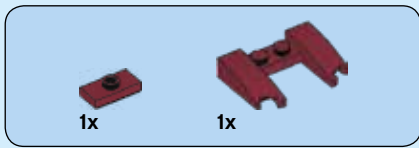

# 14

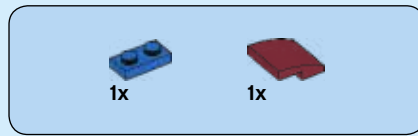
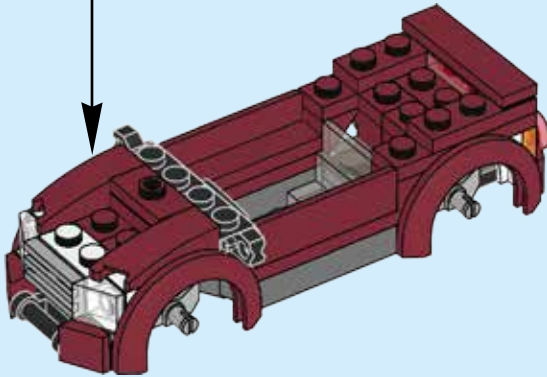
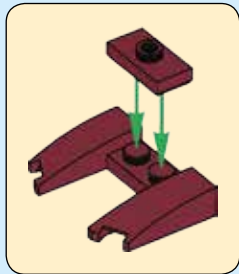

# 15

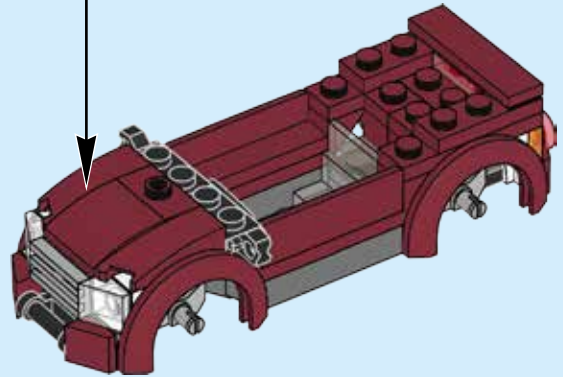
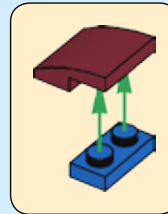

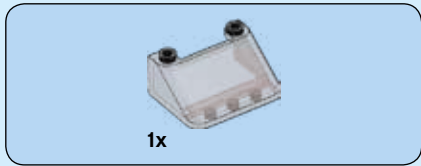

16

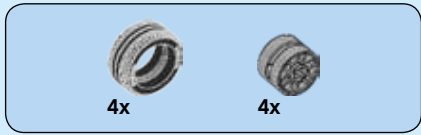
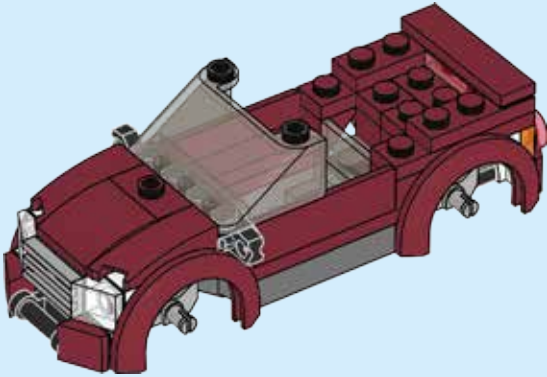

17

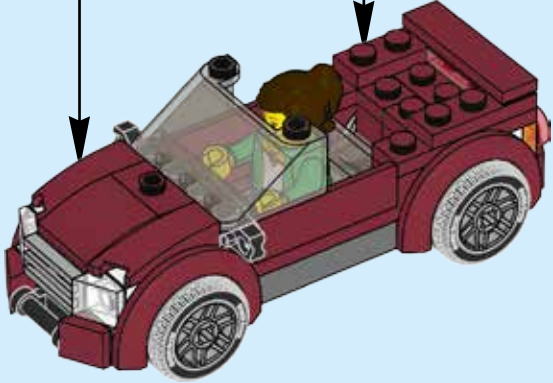
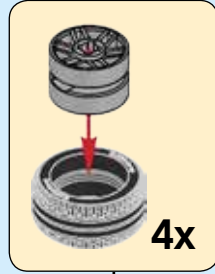



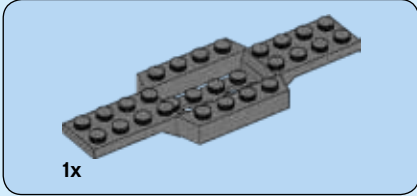
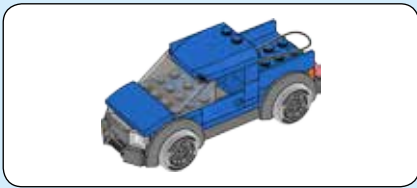

**1**

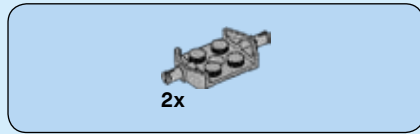
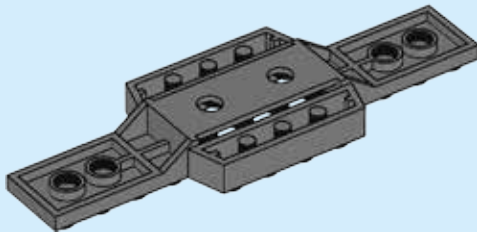

**2**

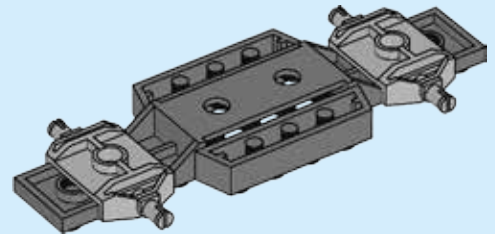



1x

**3**

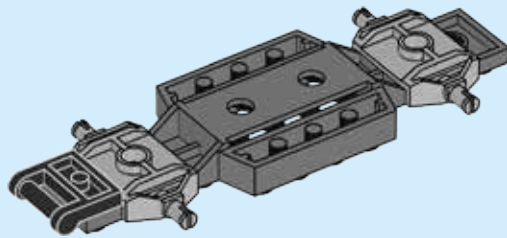

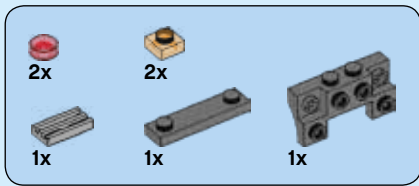

# 4

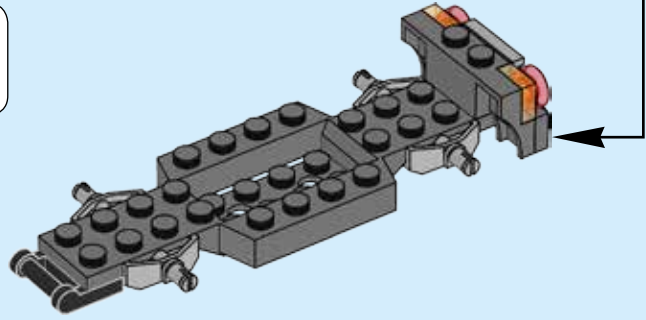
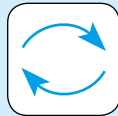
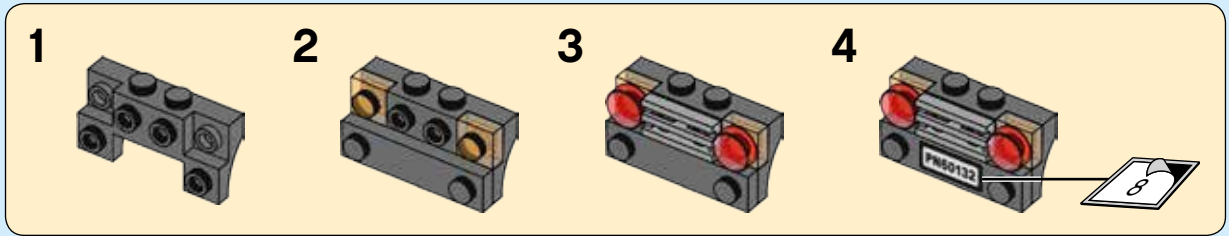



2x

5

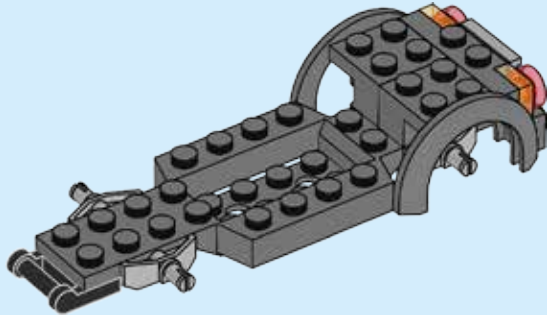

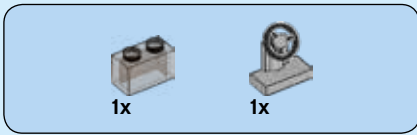

6

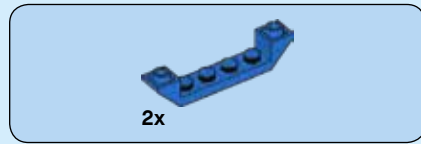
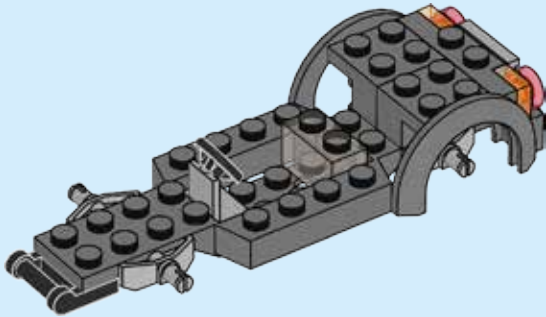

7

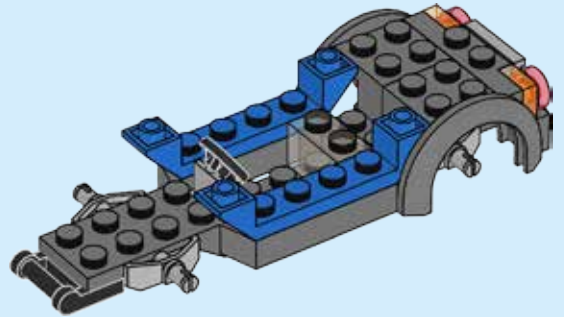

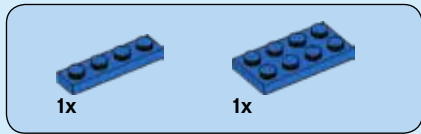

8

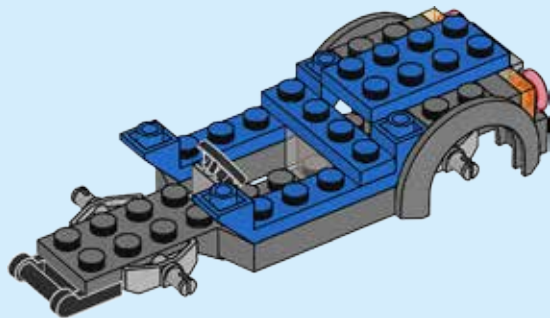

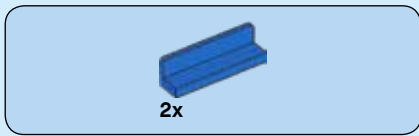

9

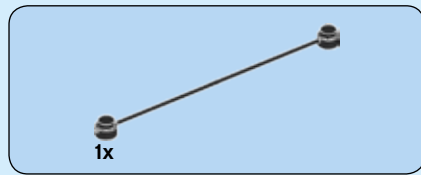
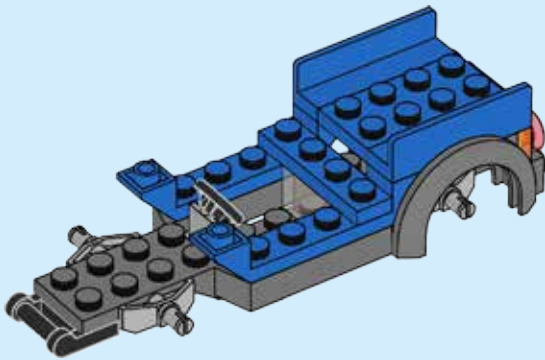

10

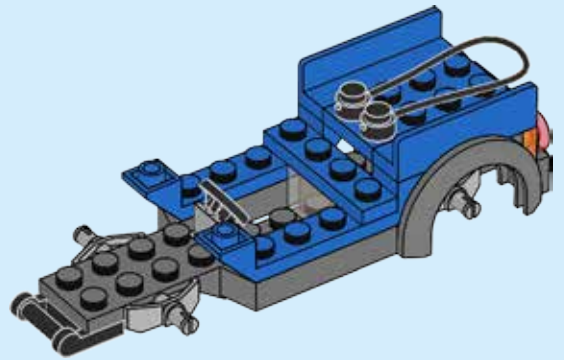



# 11

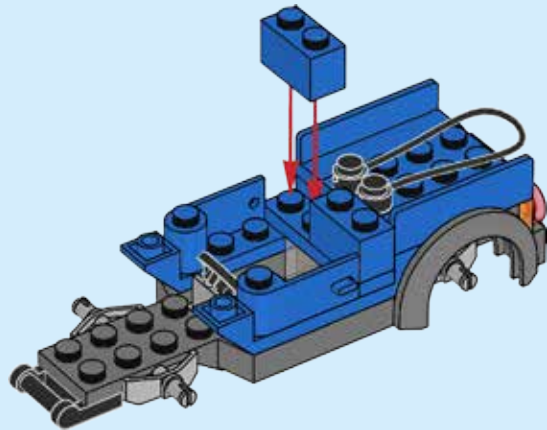



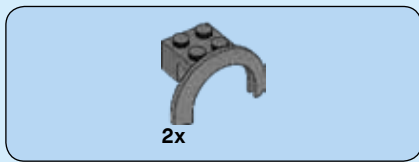

12

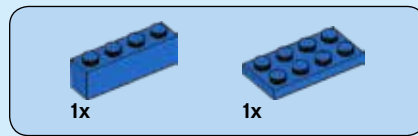
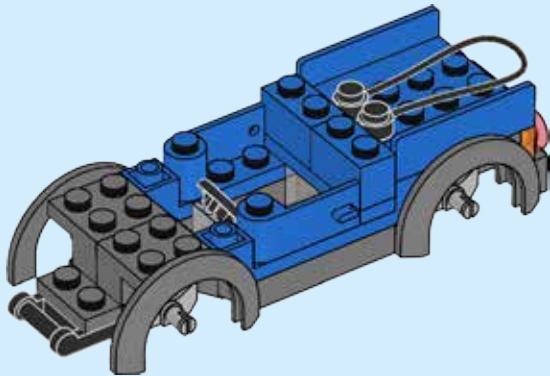

13

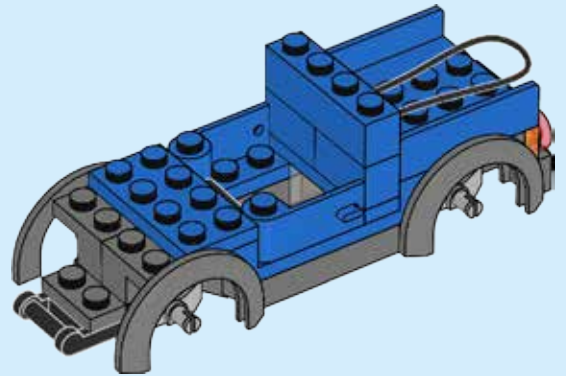

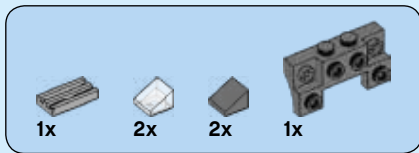

# 14

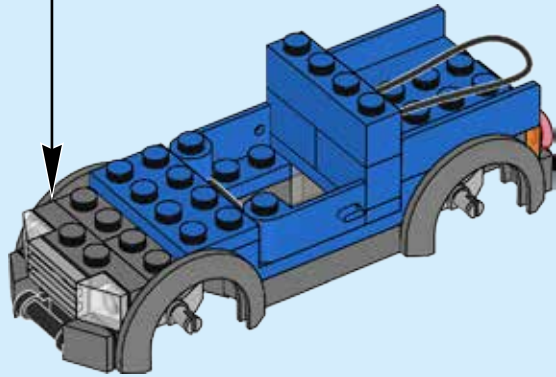
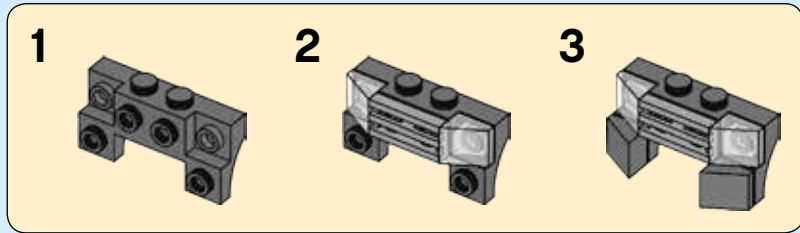

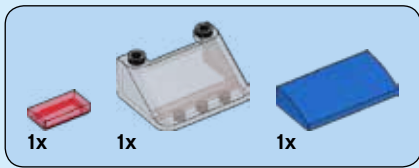

15

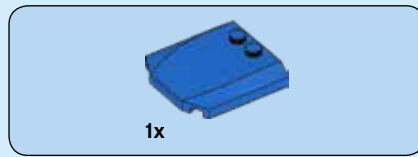
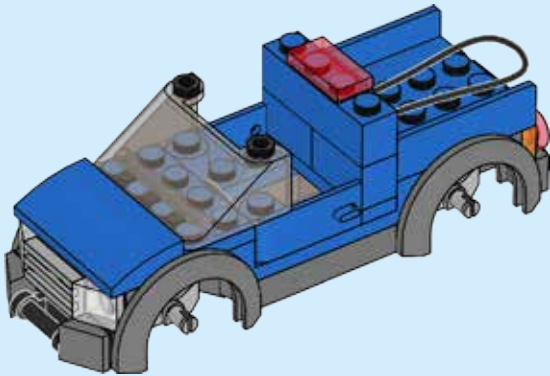

16

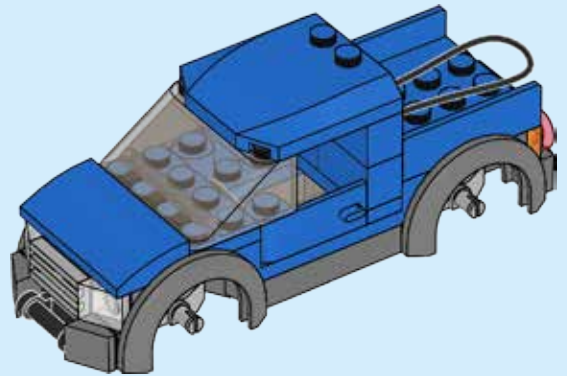

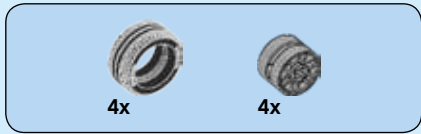

17

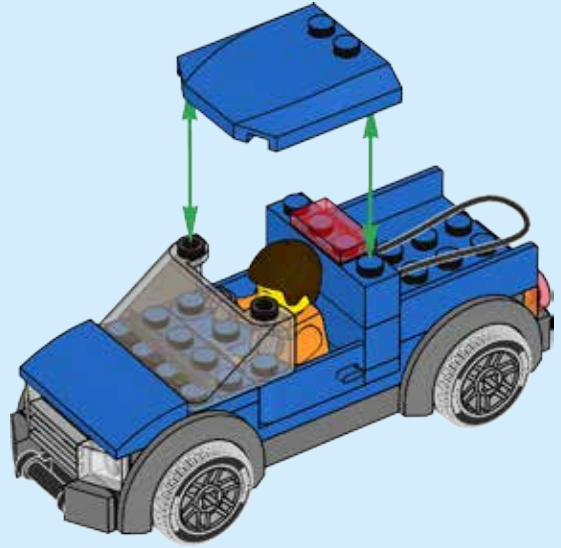
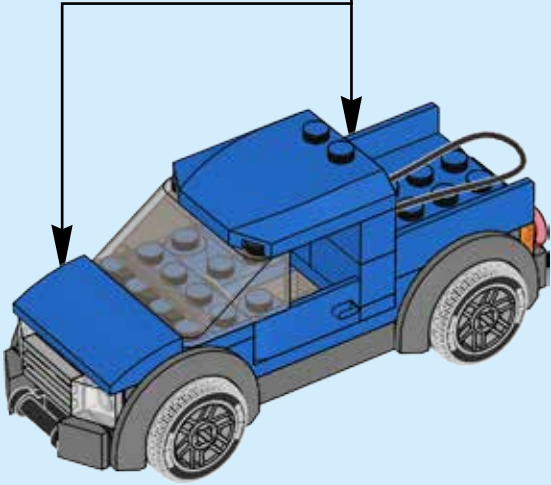
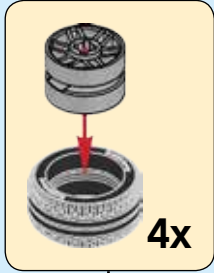

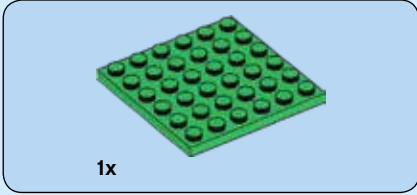

1

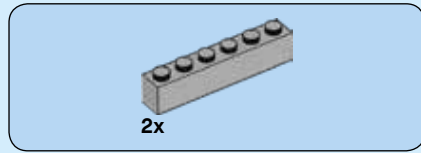
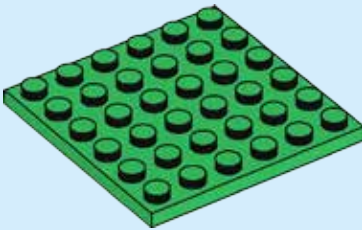

2

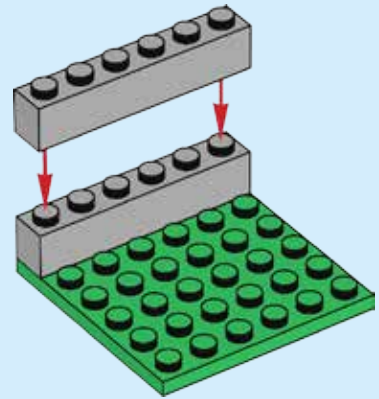

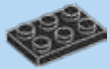

1x



3x

**3**

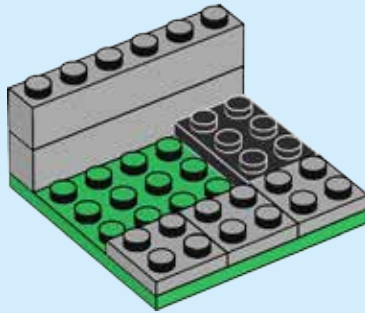



4

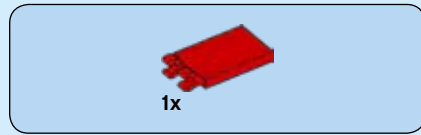
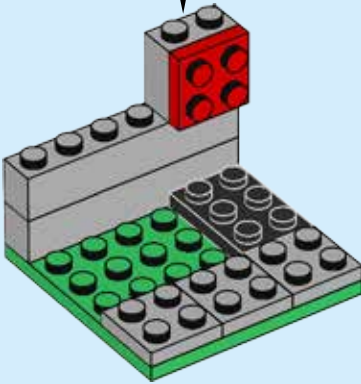
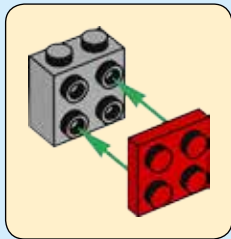

5

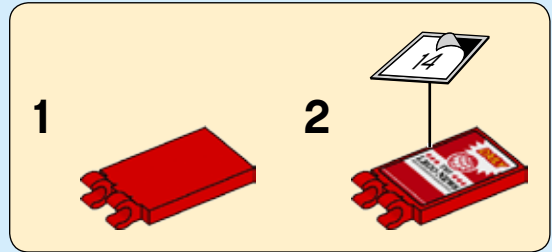

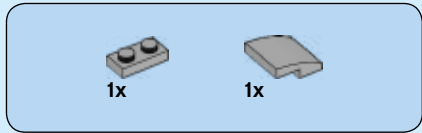

6

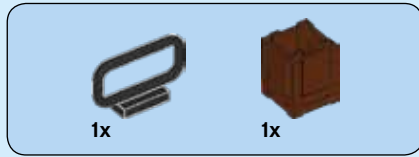
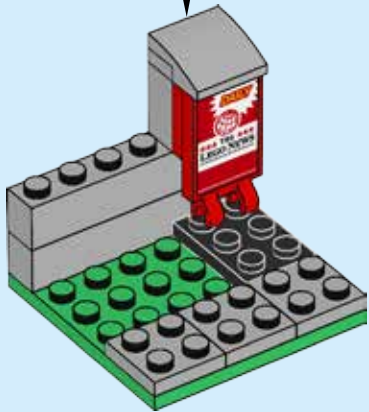
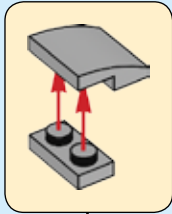

7





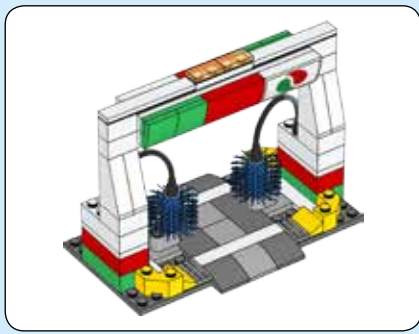

**1**

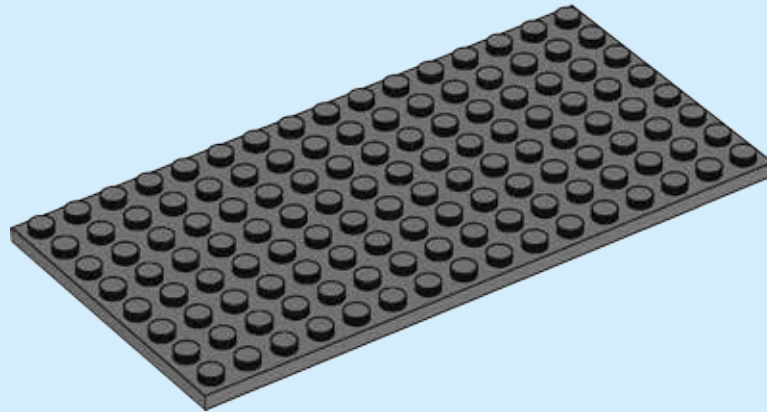

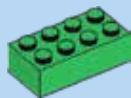

2x

2

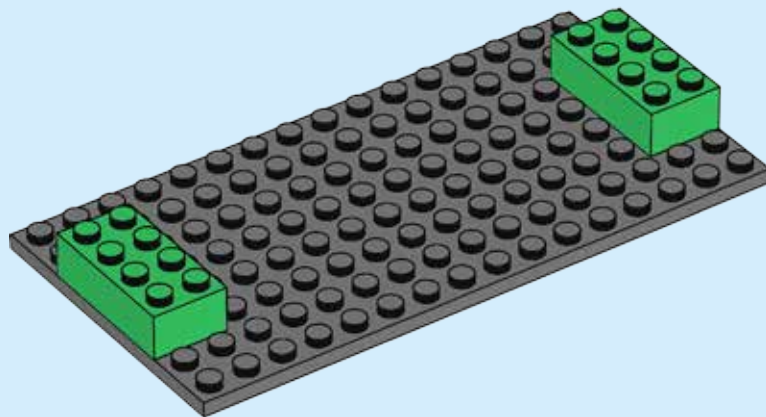

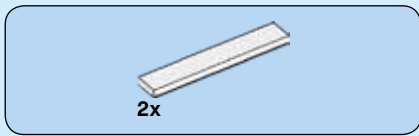

**3**

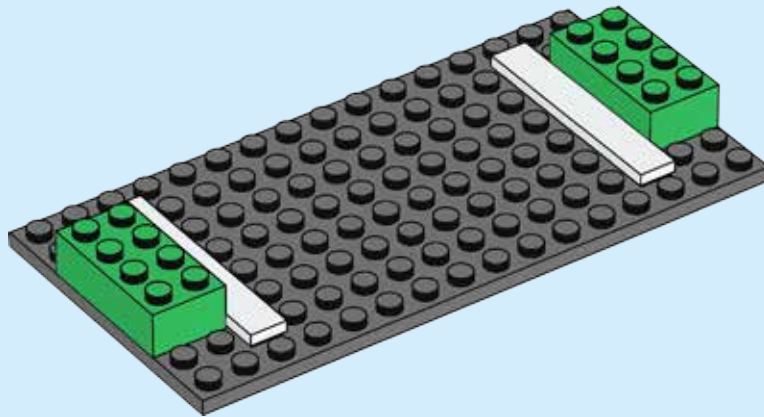



4x

4

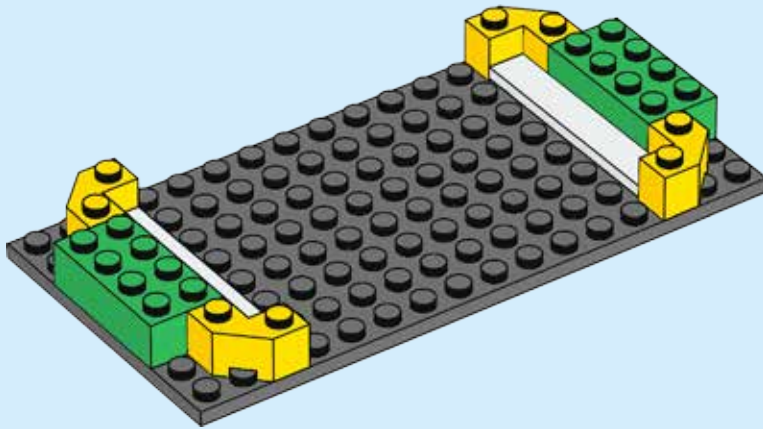

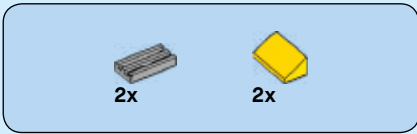

5

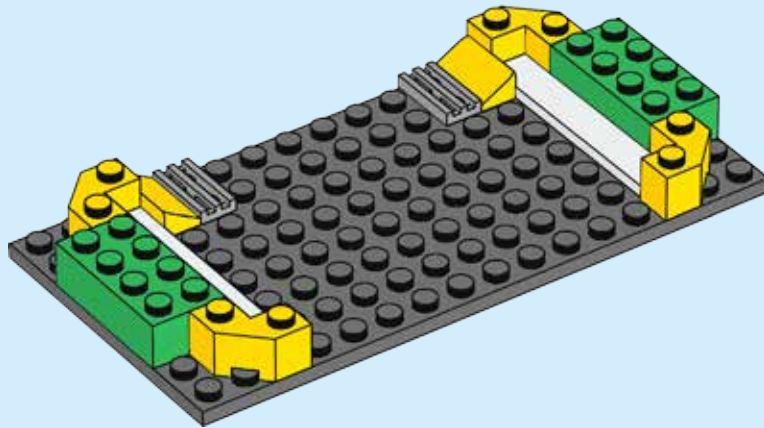

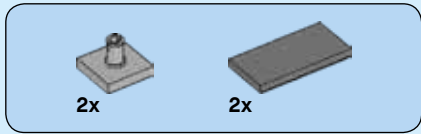

6

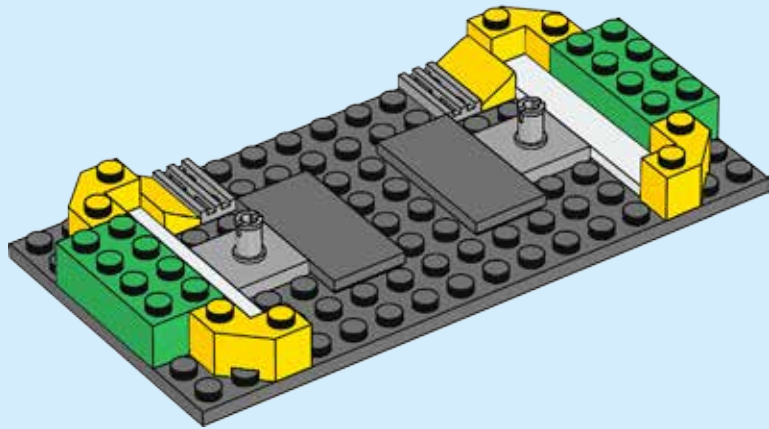

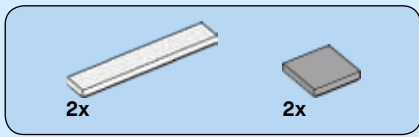

7

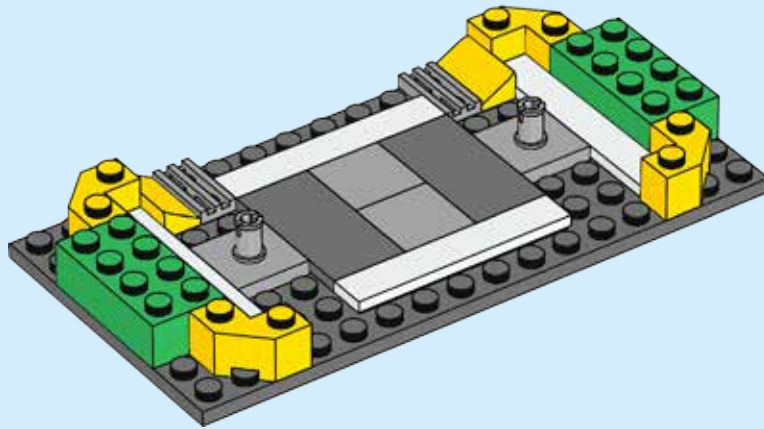



4x



2x

8

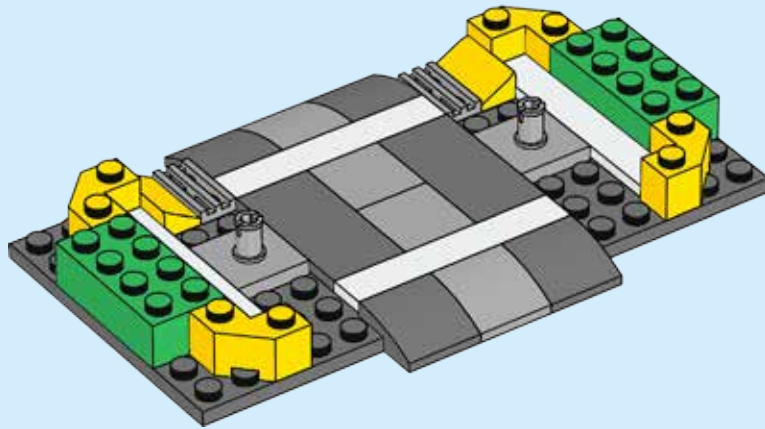



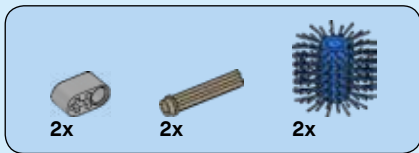

9

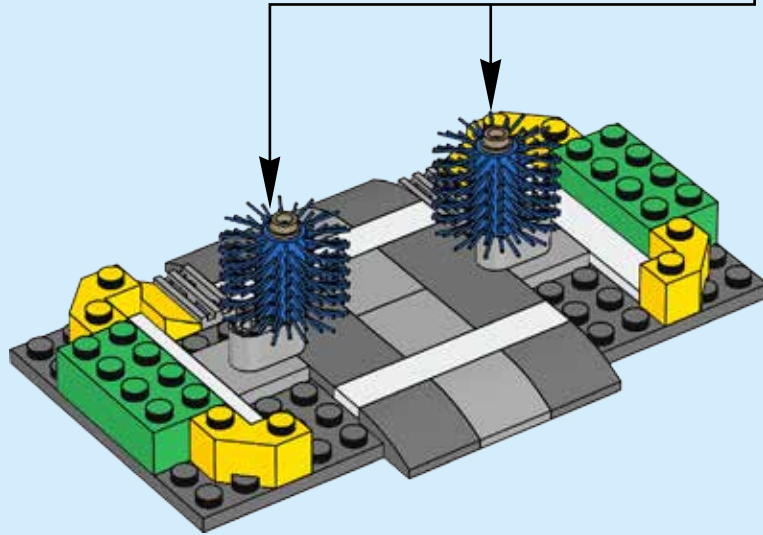
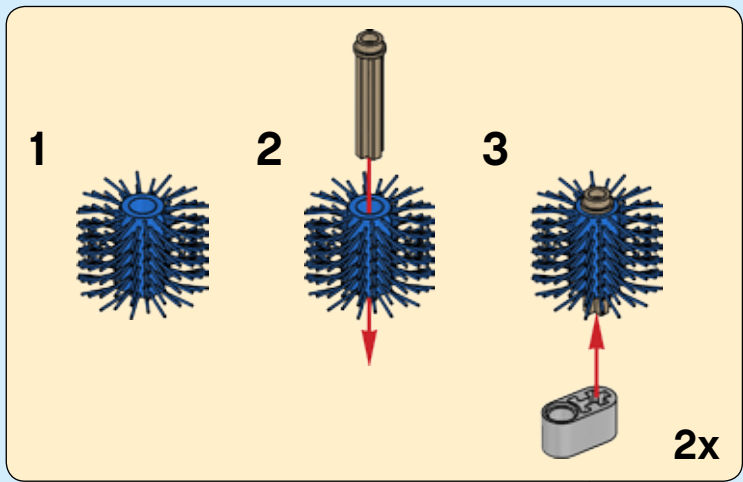



2x

# 10

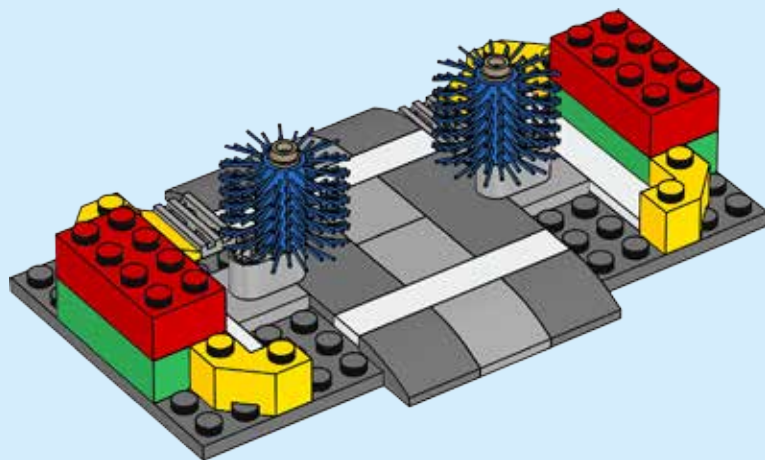



2x

# 11

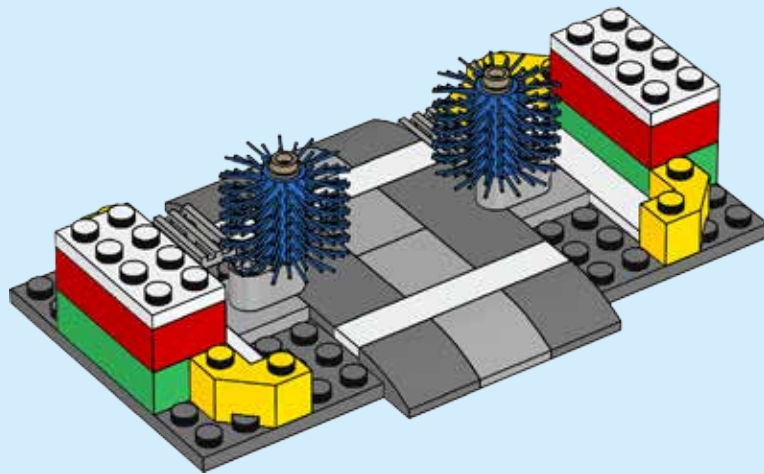



2x

# 12

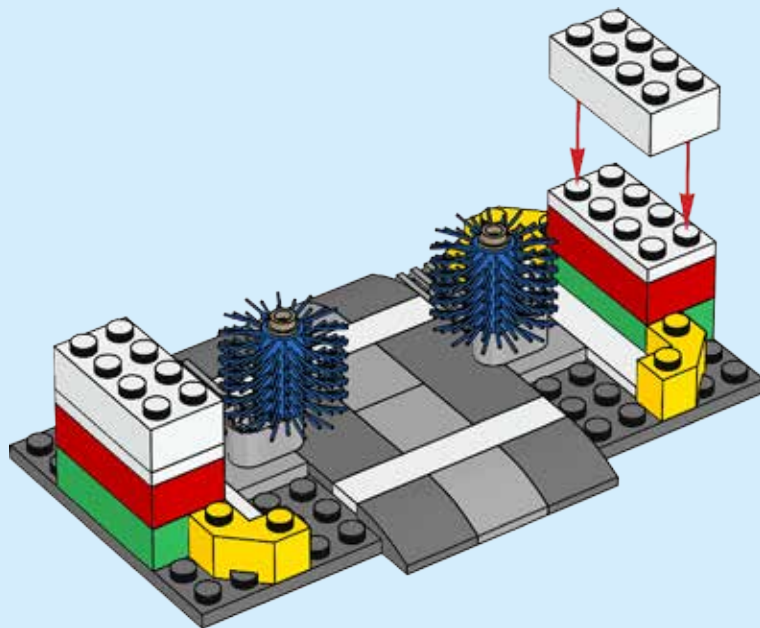



2x

# 13

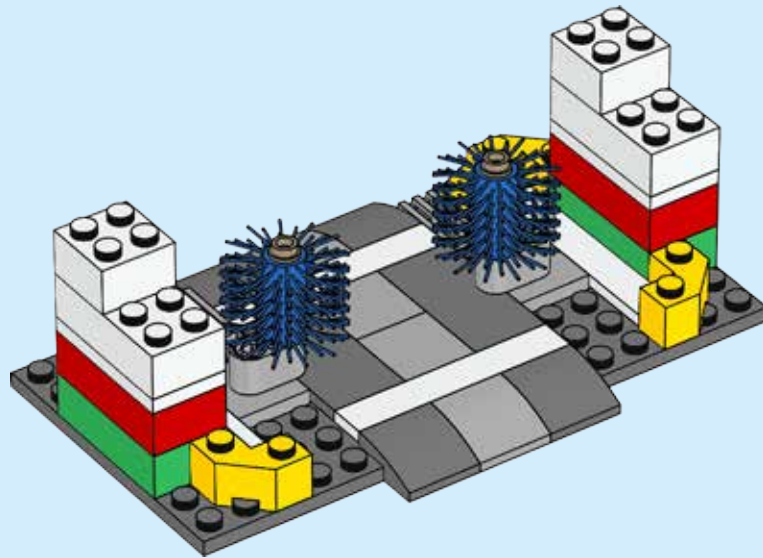

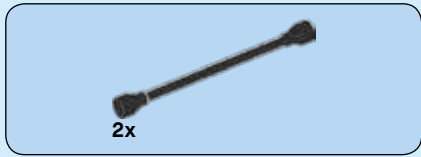

14

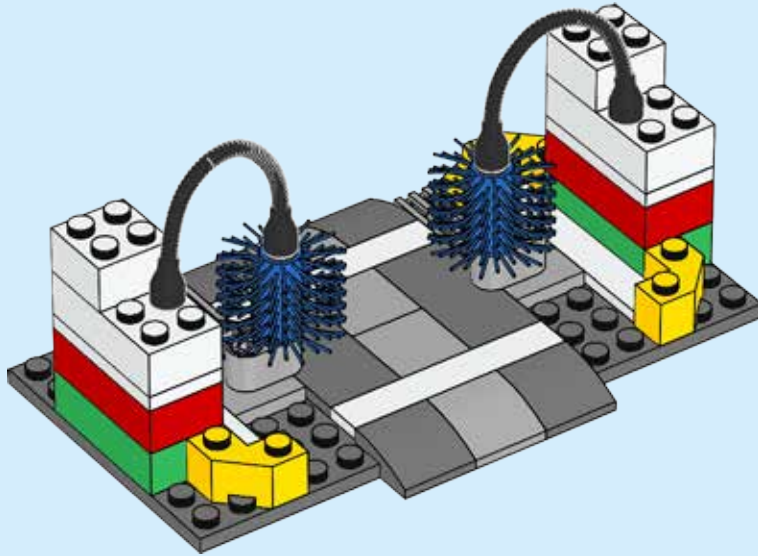

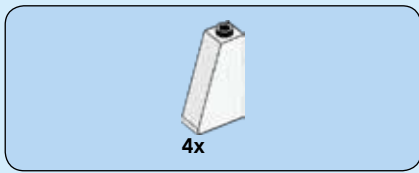

15

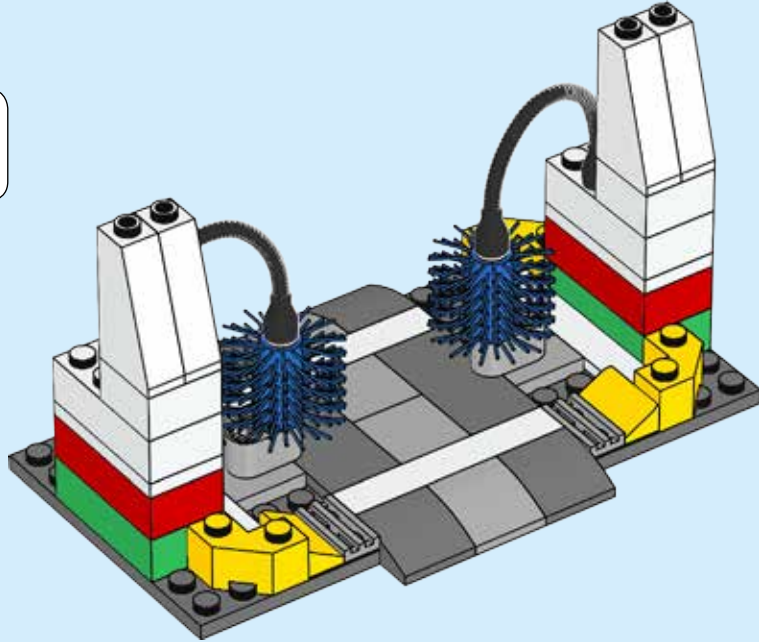
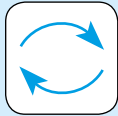

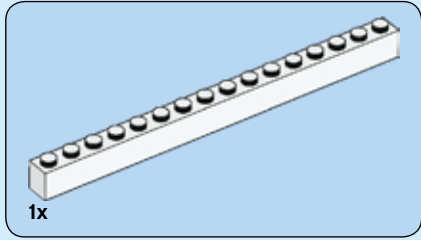
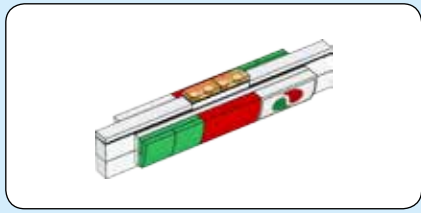

16

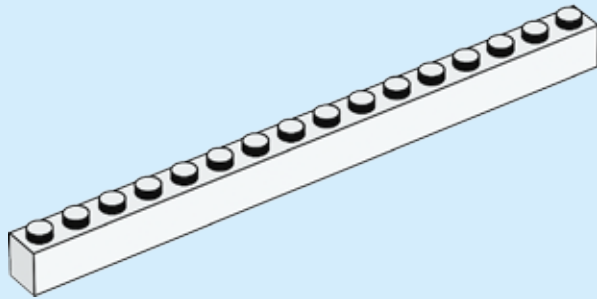



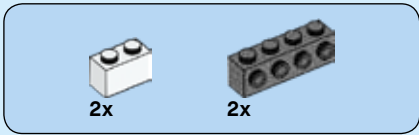

17

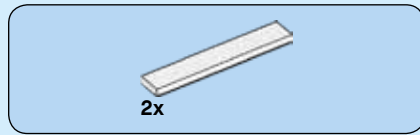
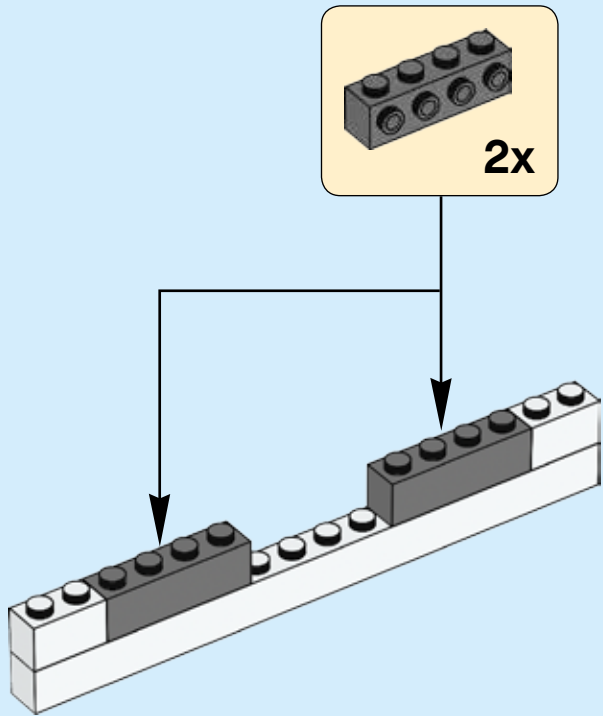

18

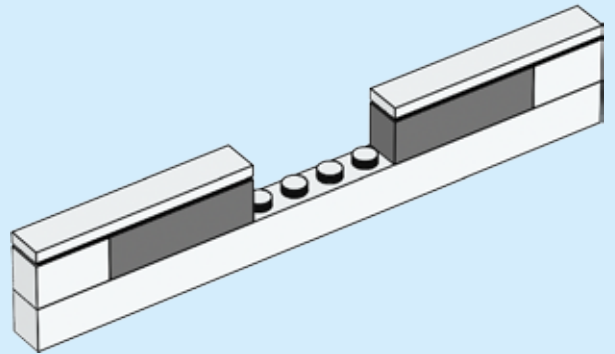

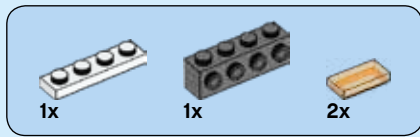

# 19

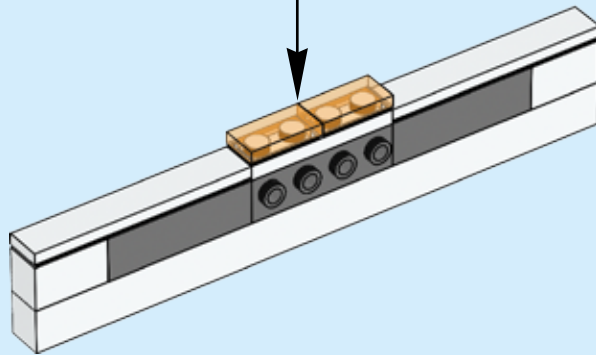
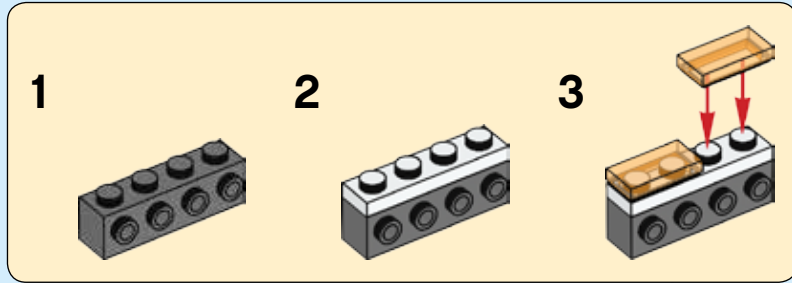

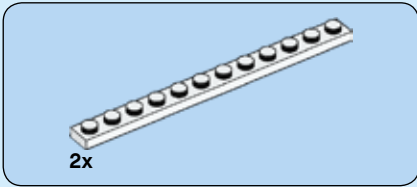
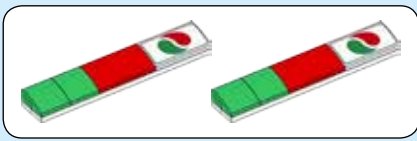

20

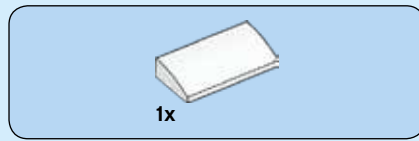
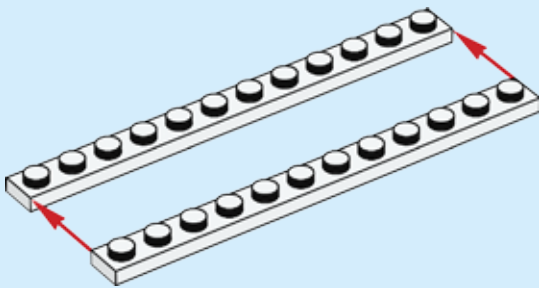

21

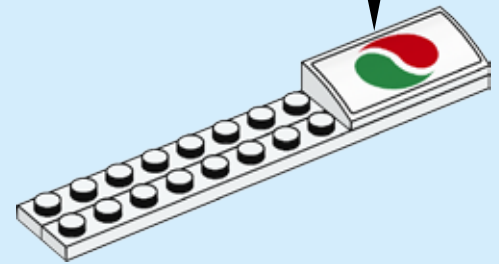
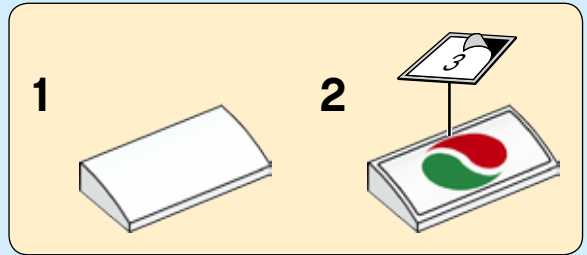

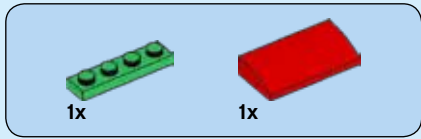

22

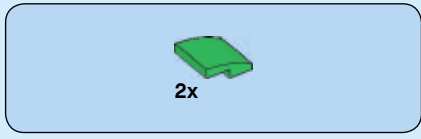
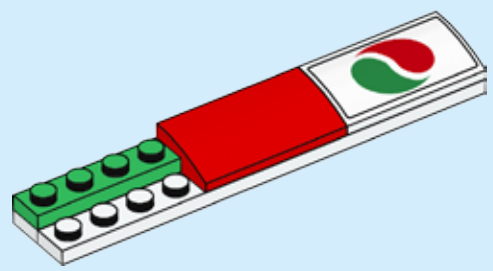

23

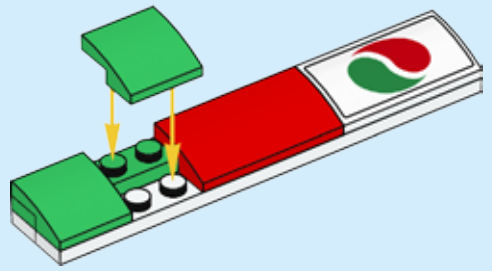

2x

24

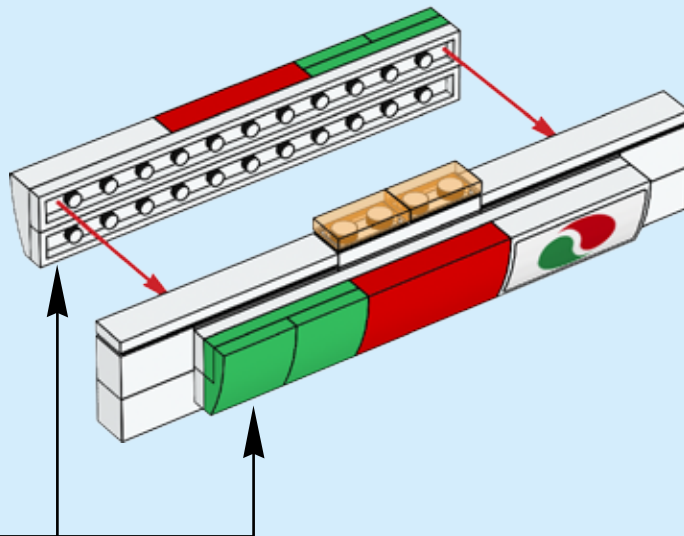

25

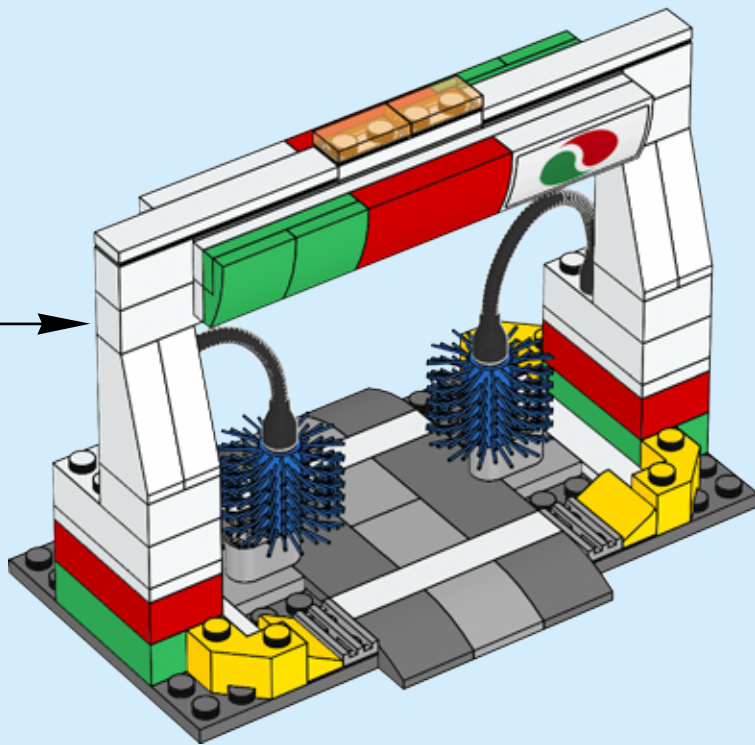



2x

1

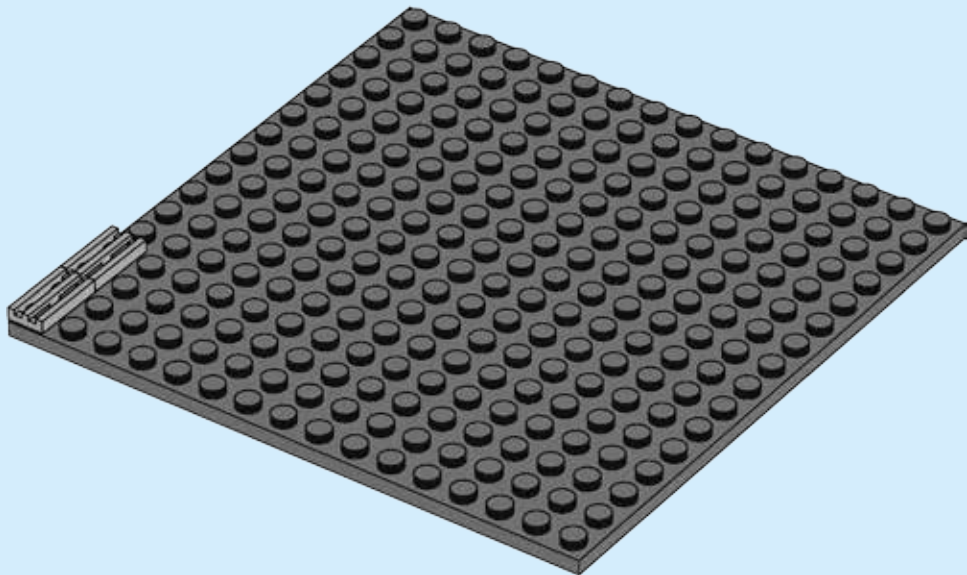

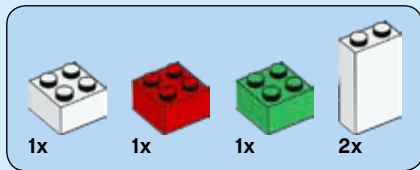

2

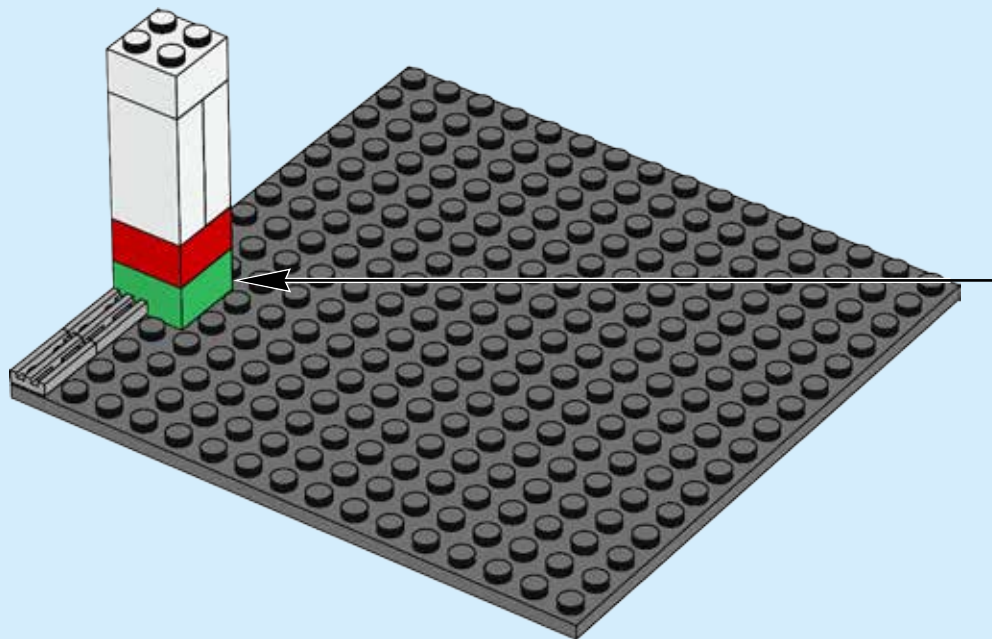
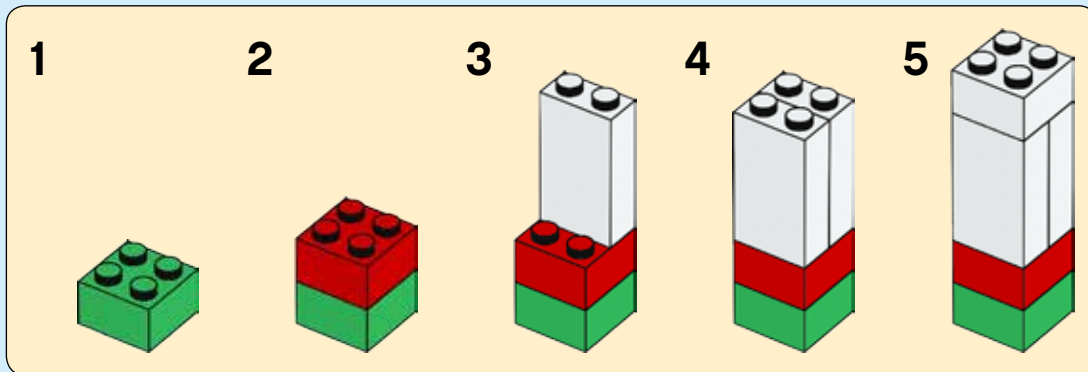



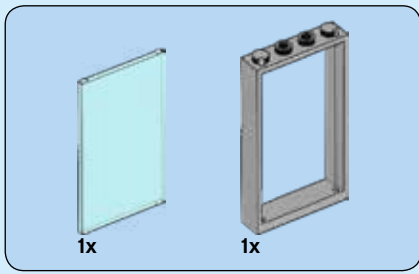

3

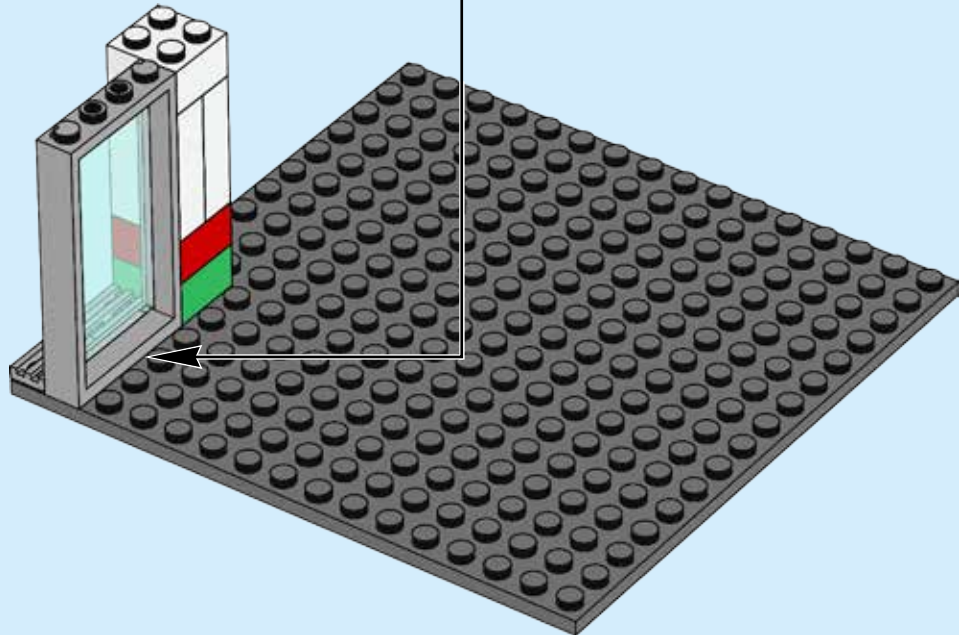
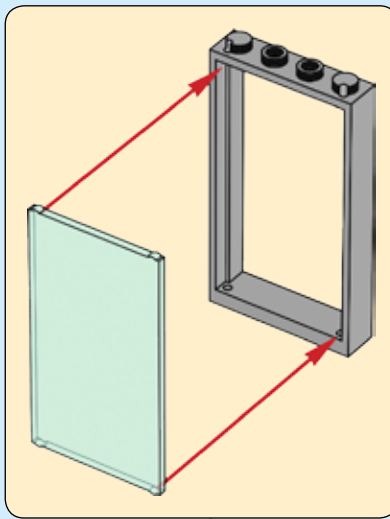

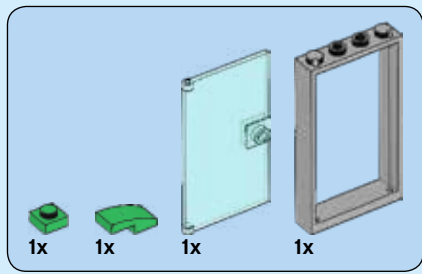

4

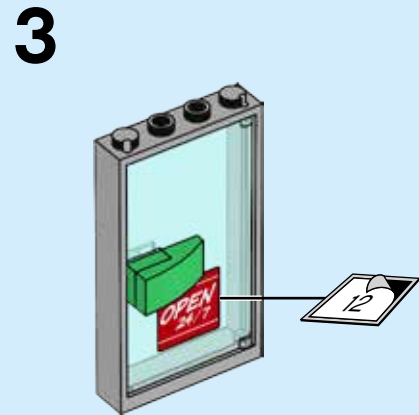
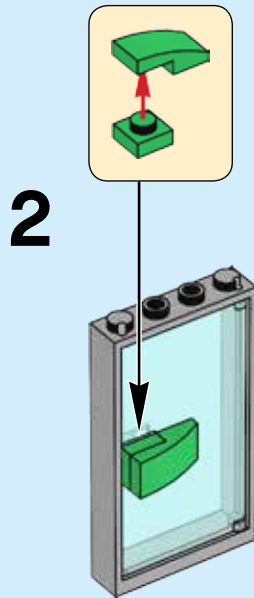
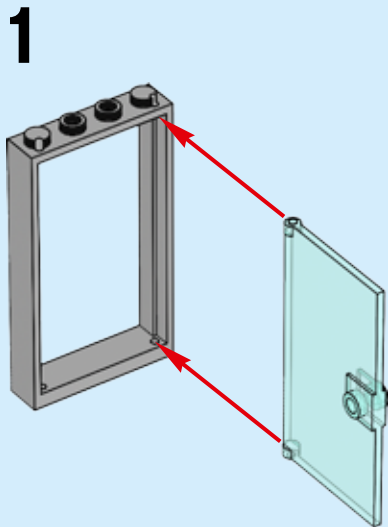

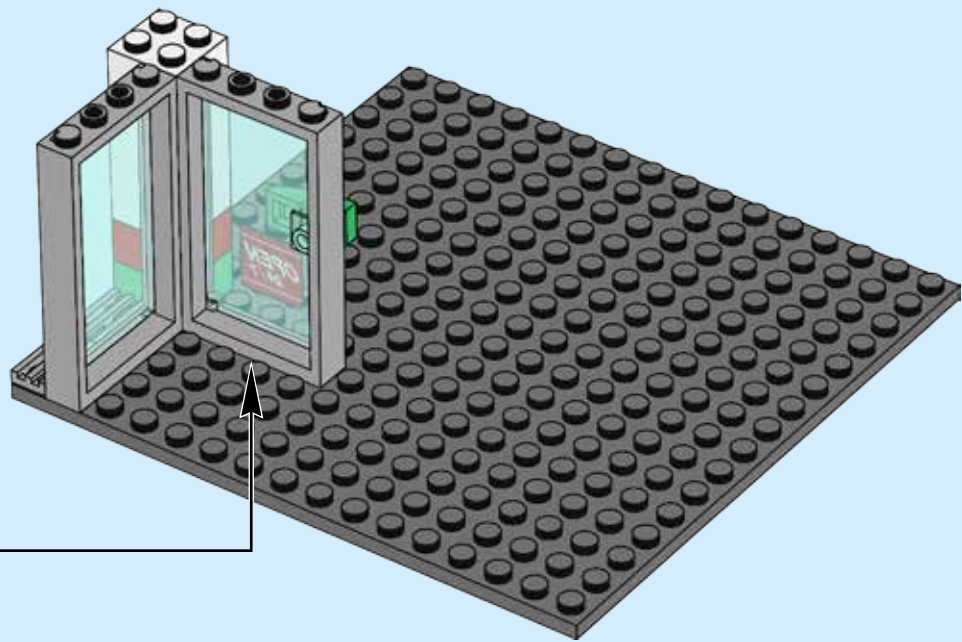



2x

5

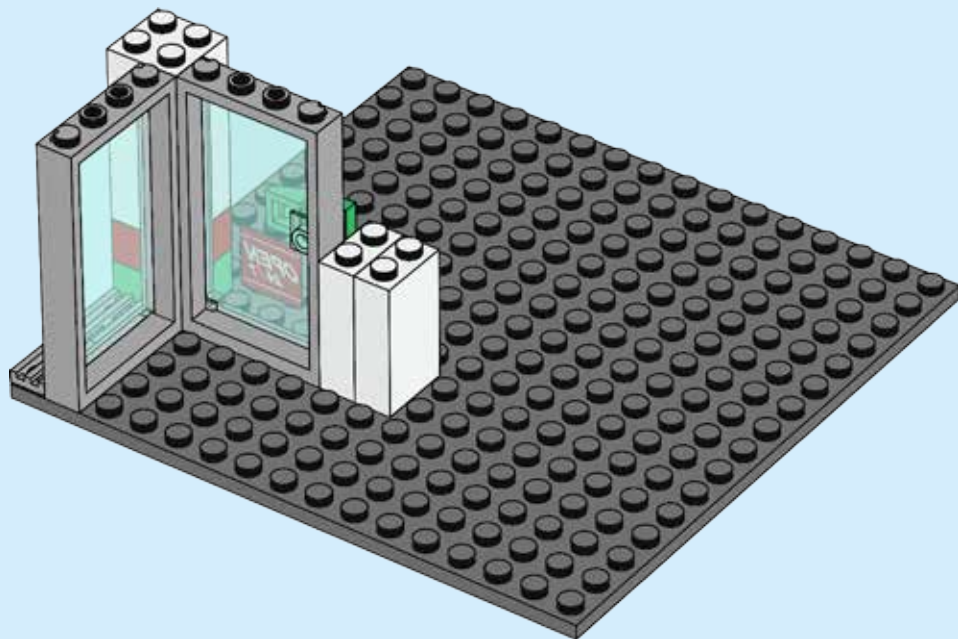

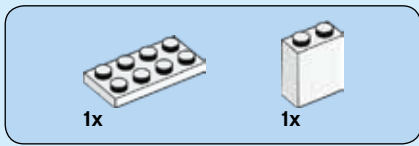

6

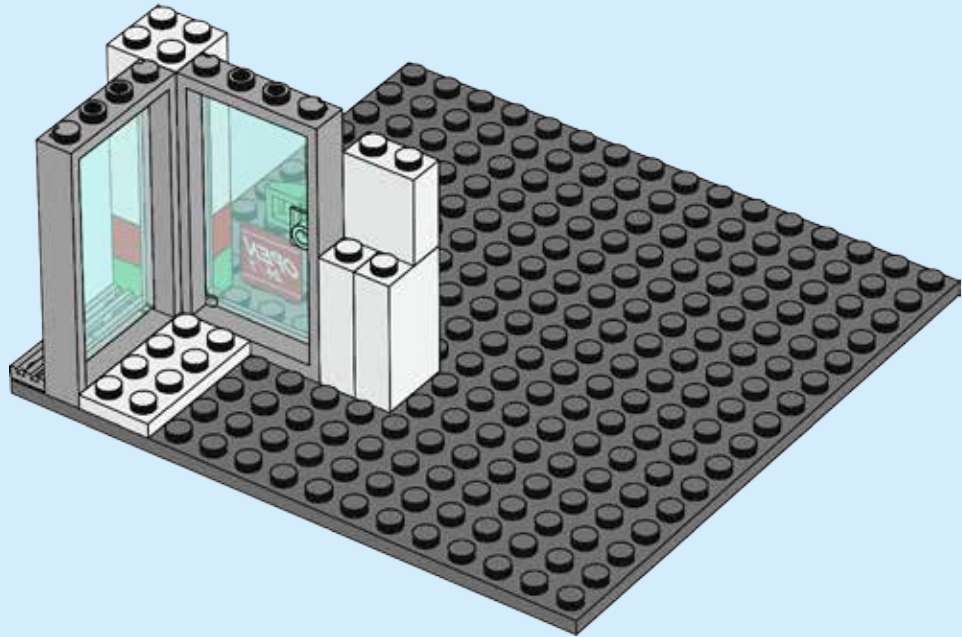



7

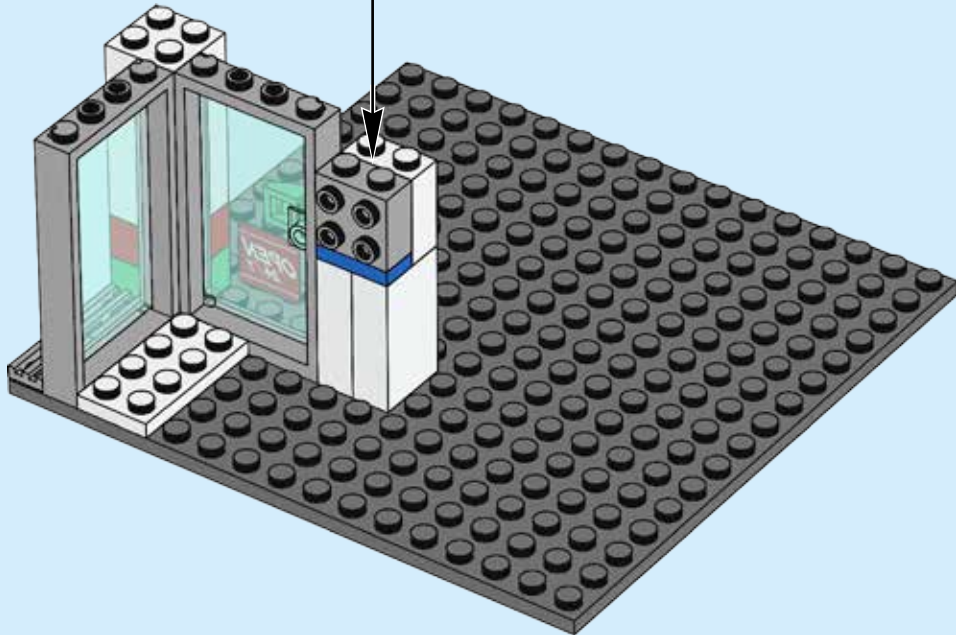
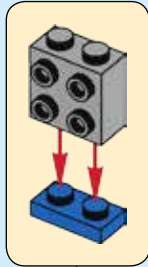



8

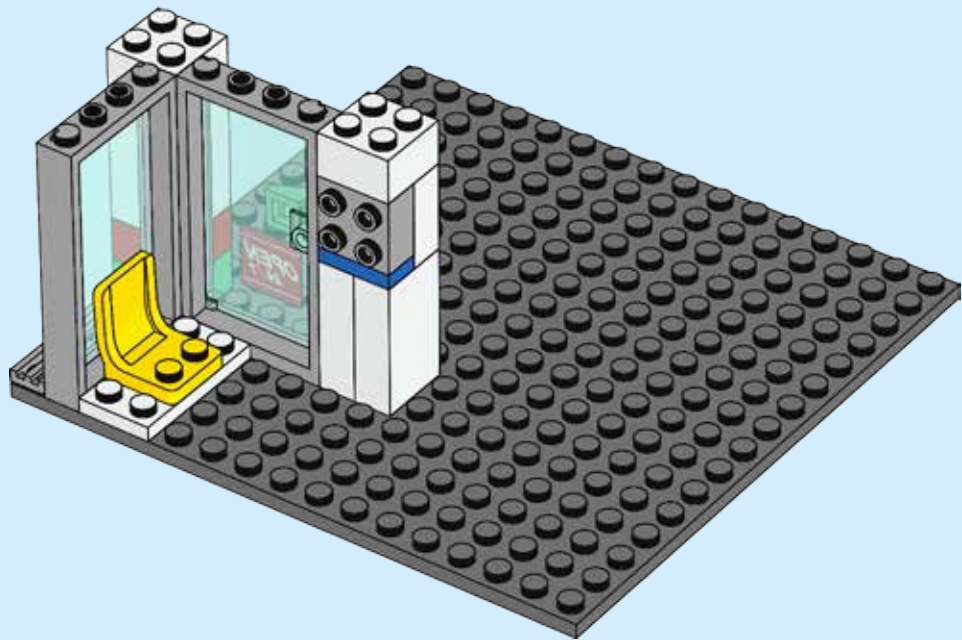

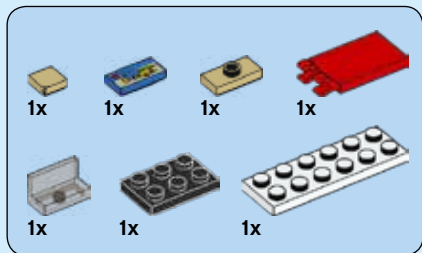

# 9

## 1



## 2

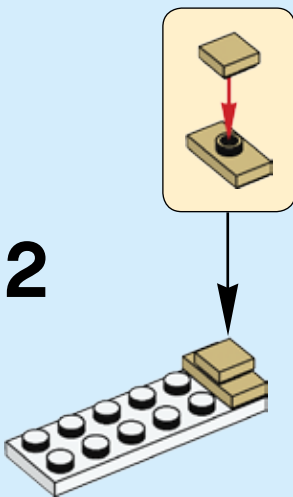

## 3





4

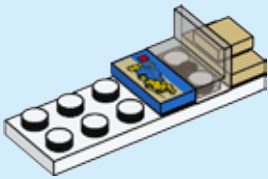

5

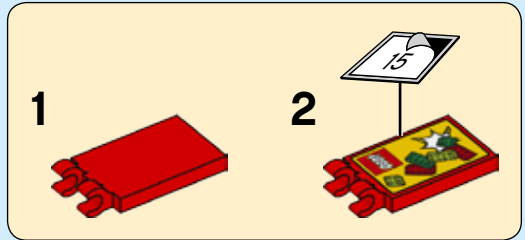
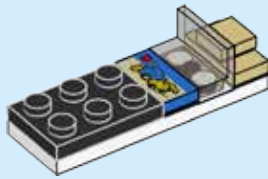

6

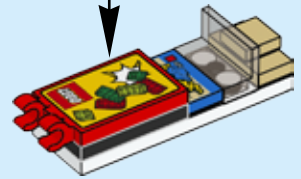

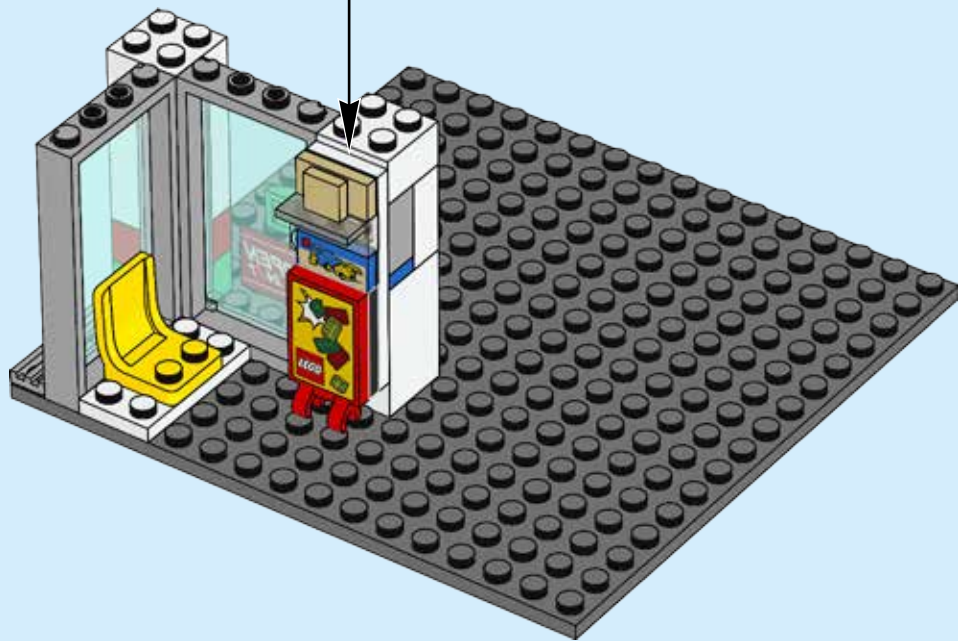

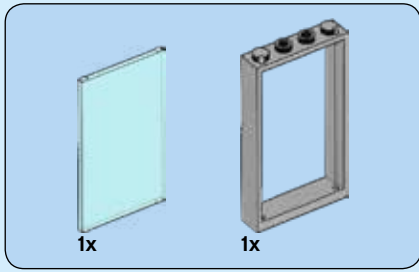

# 10

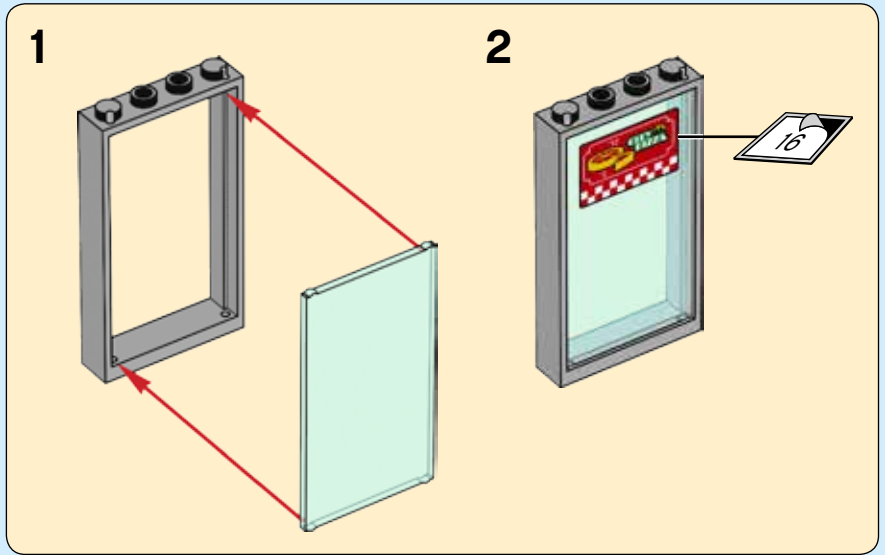



1x

# 11



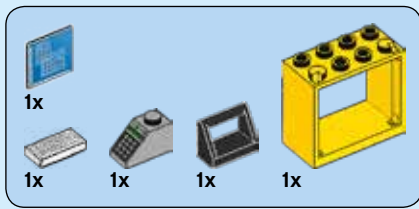

# 12

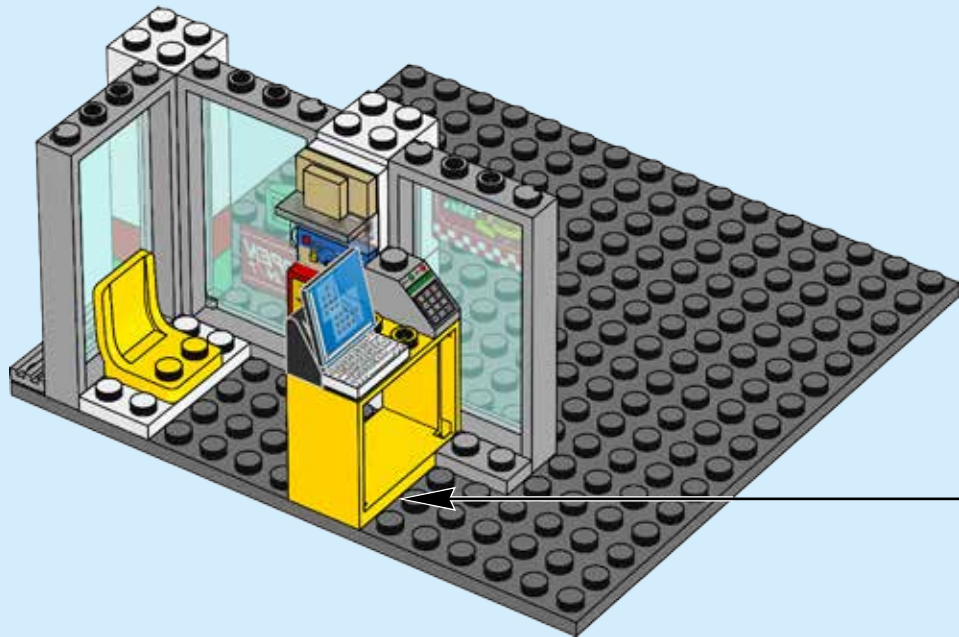
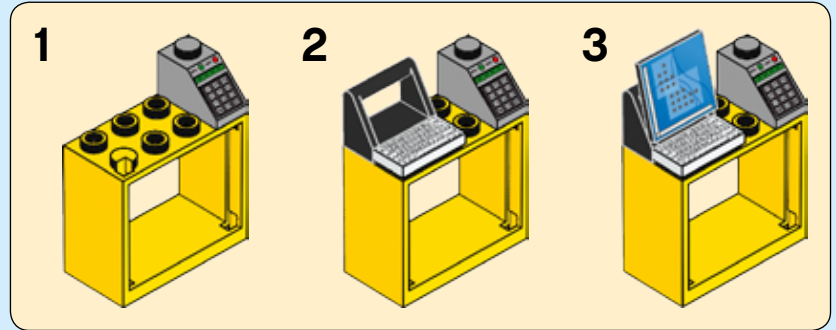

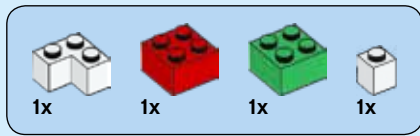

# 13

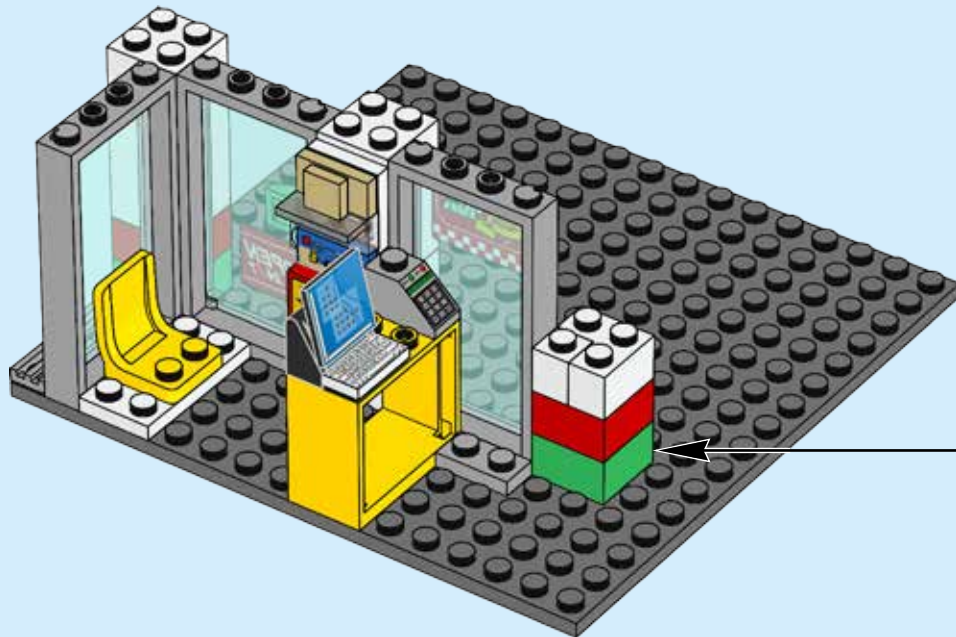
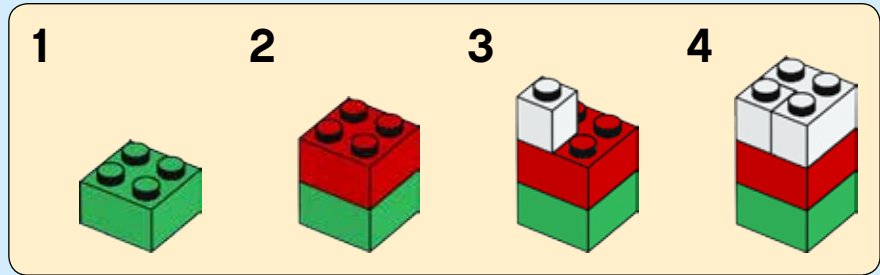



1x



2x

# 14

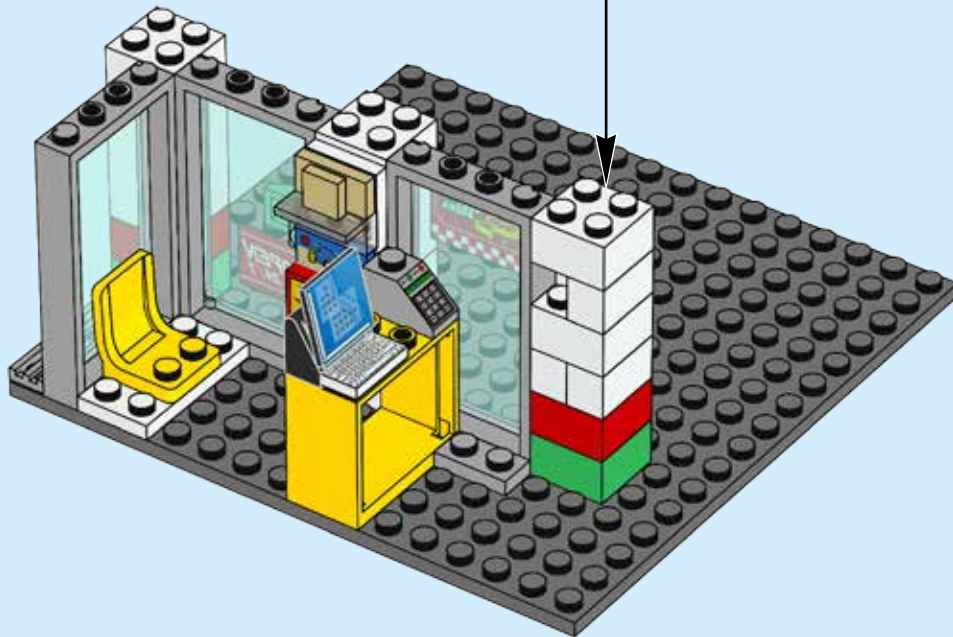
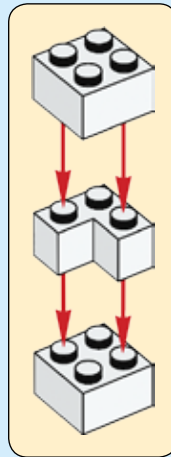

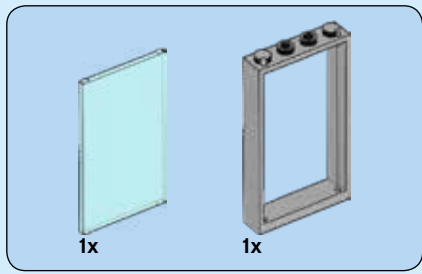

15

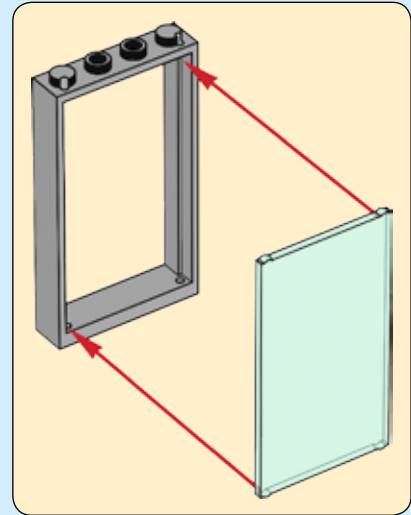



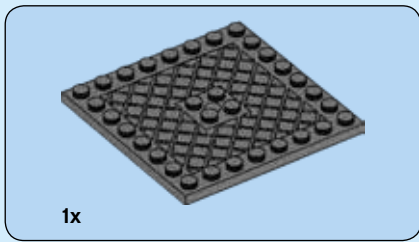

# 16

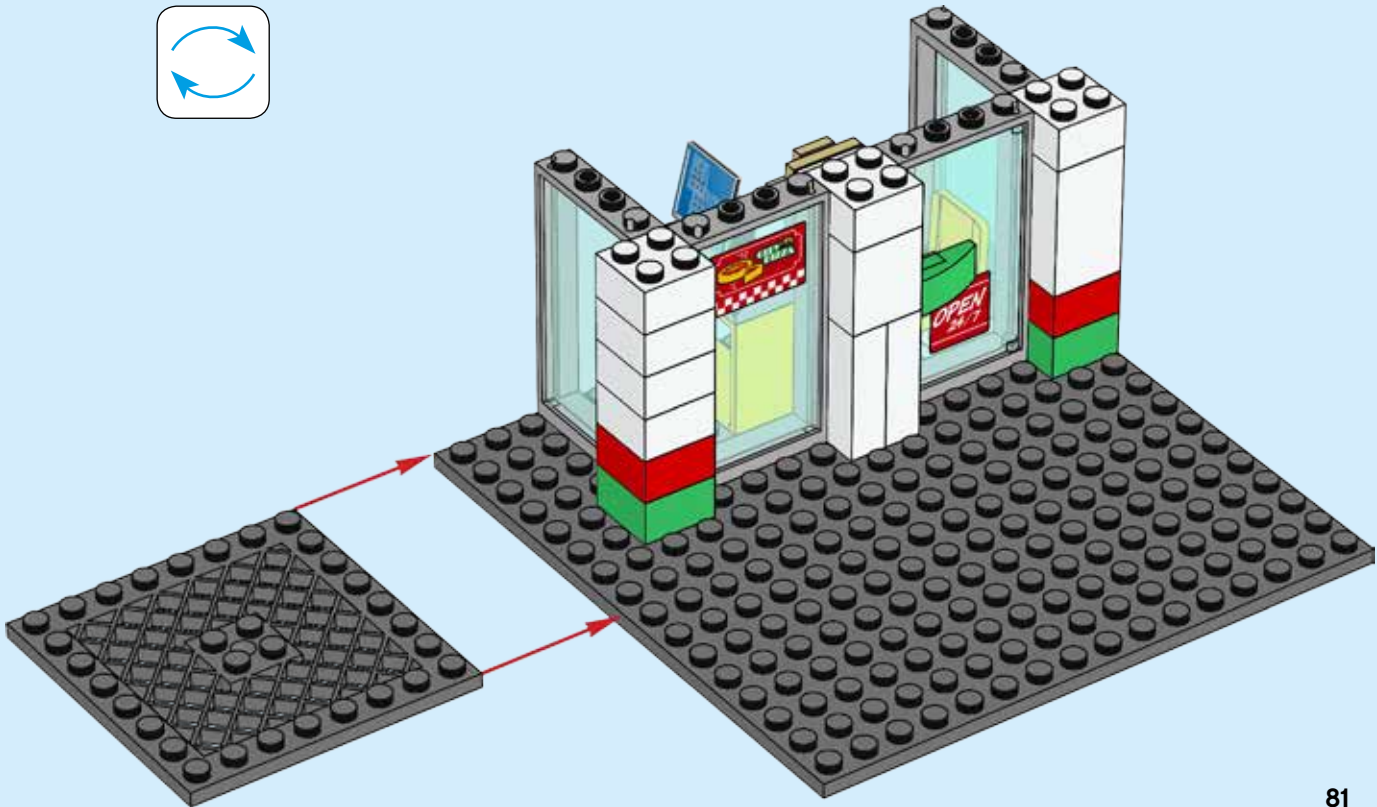
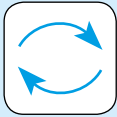

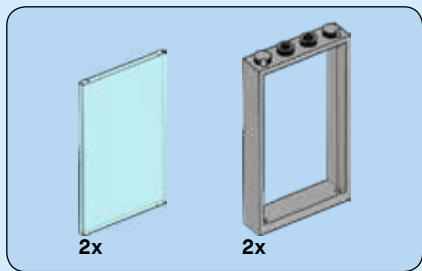

17

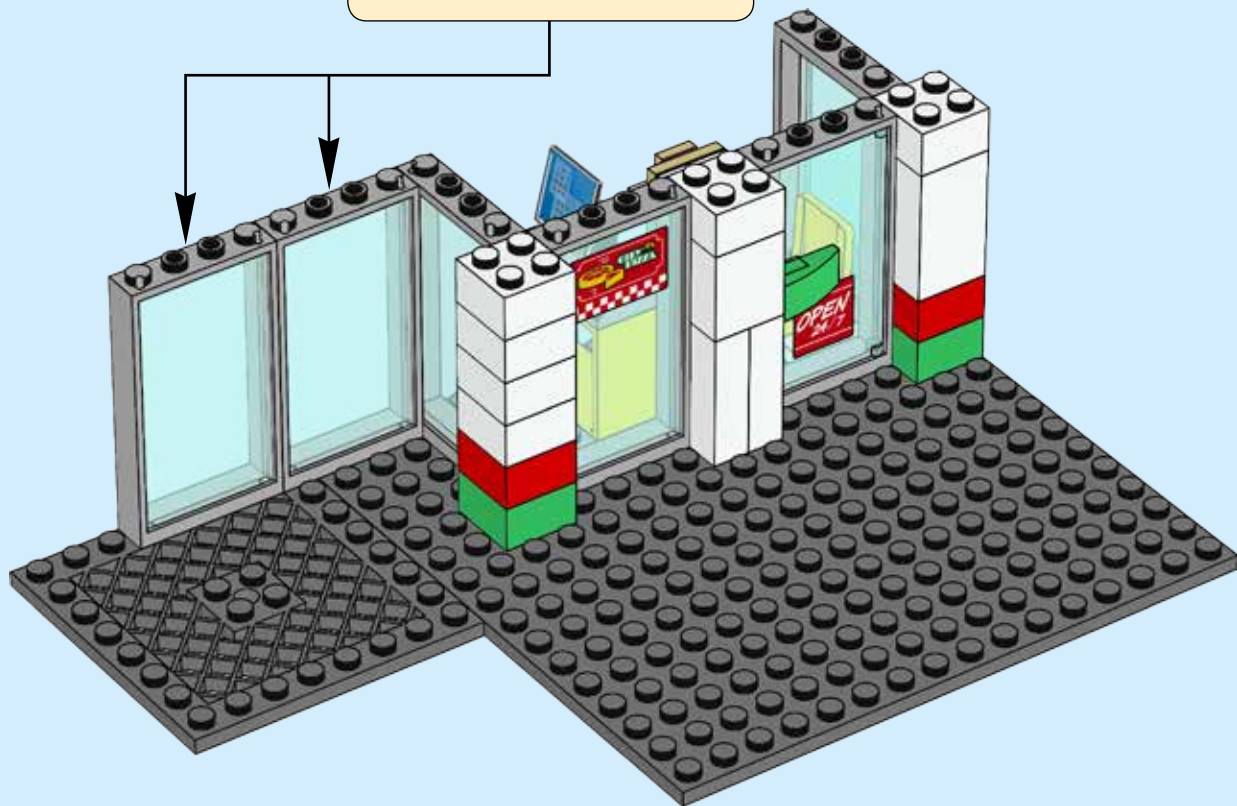
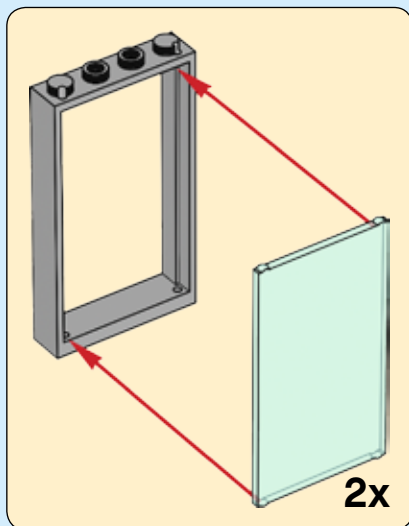



2x

# 18

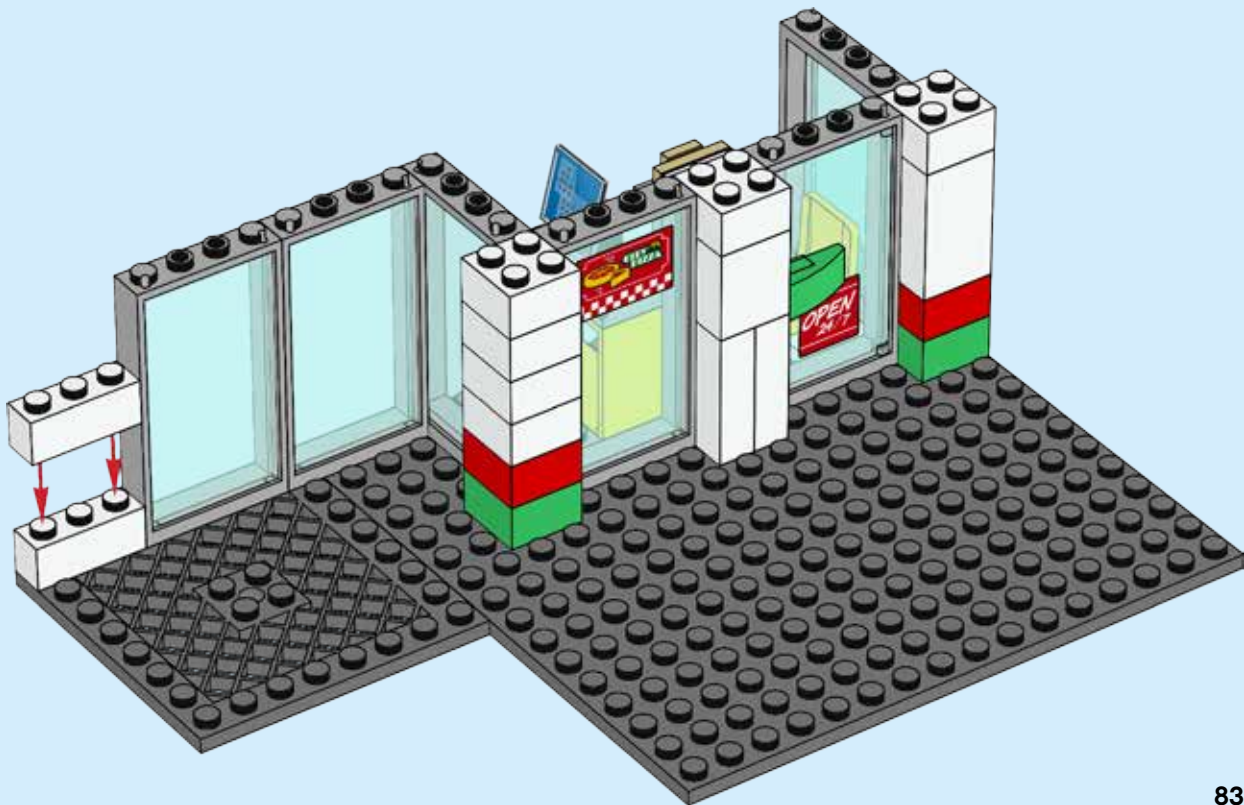



1x



1x



1x

# 19

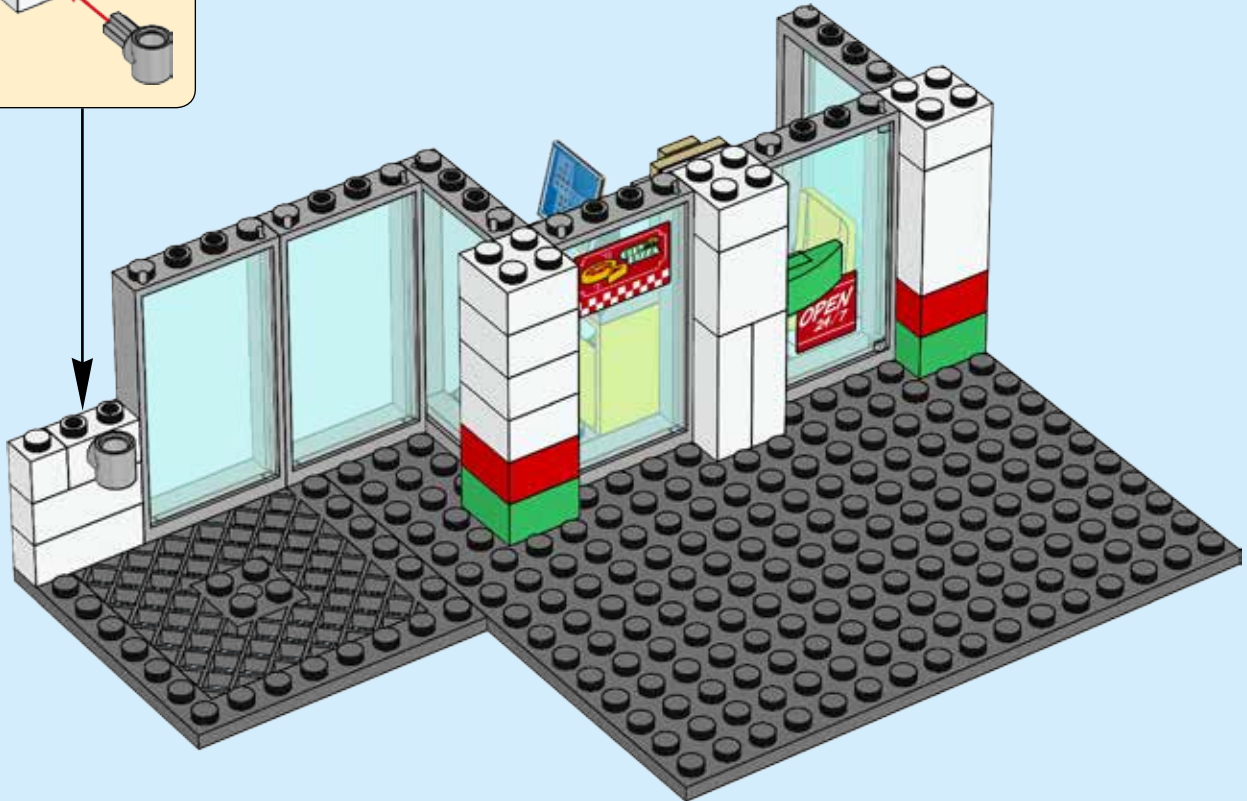
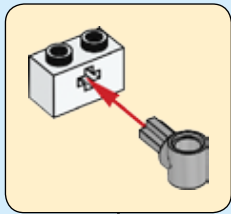



1x



1x



1x

# 20

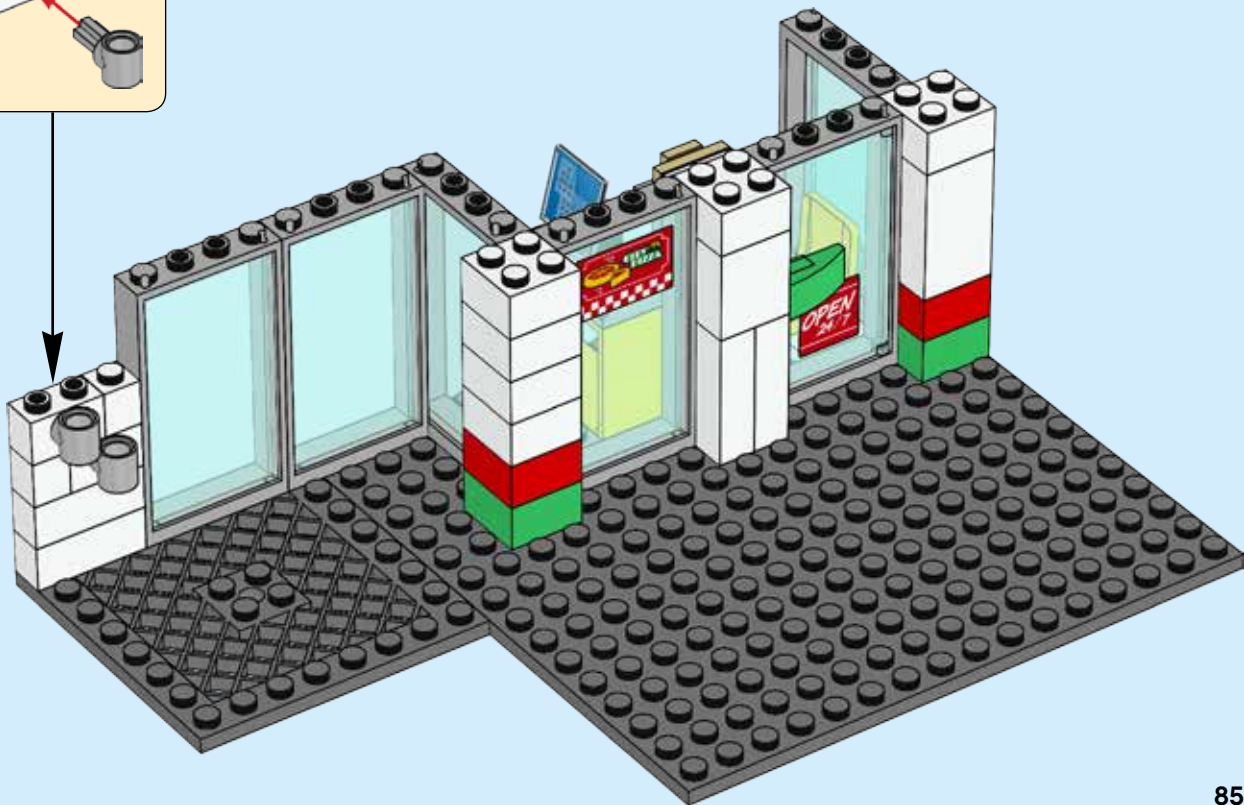
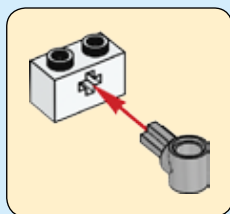



2x

# 21

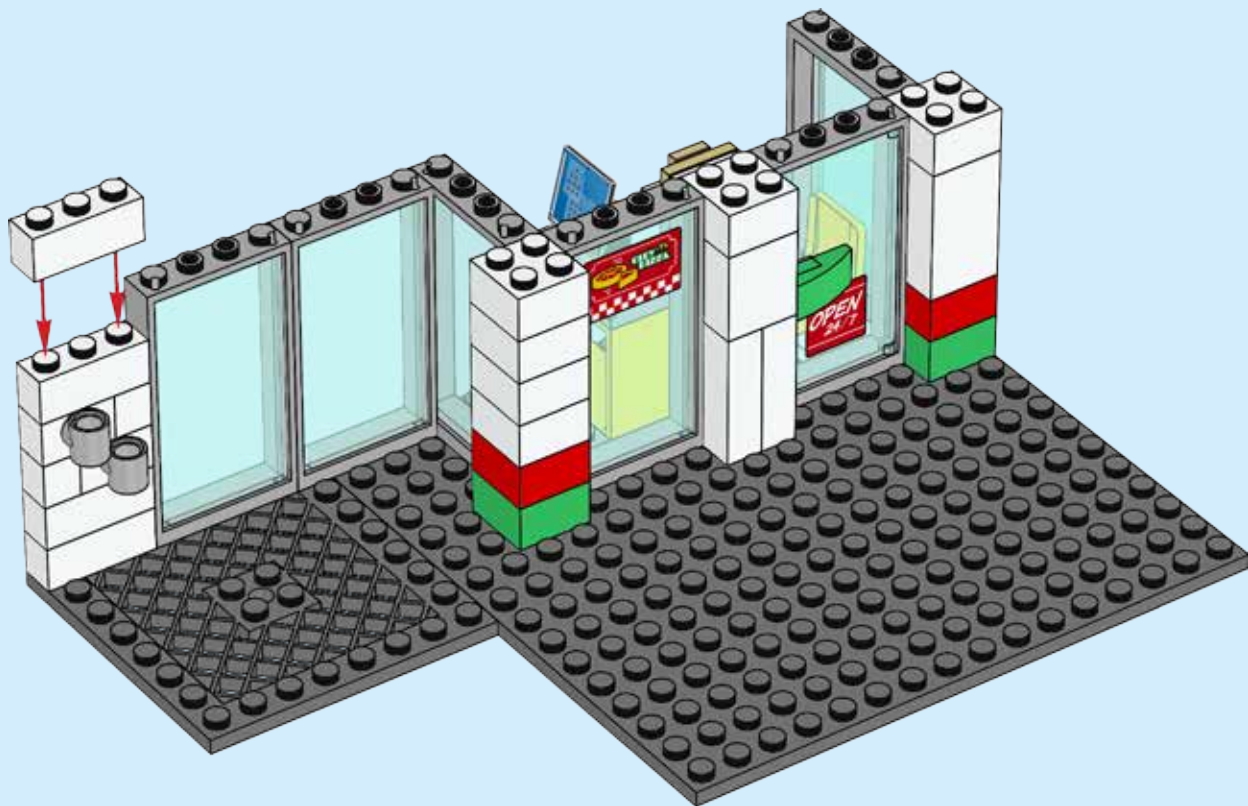

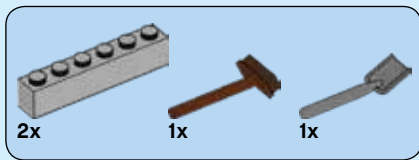

# 22

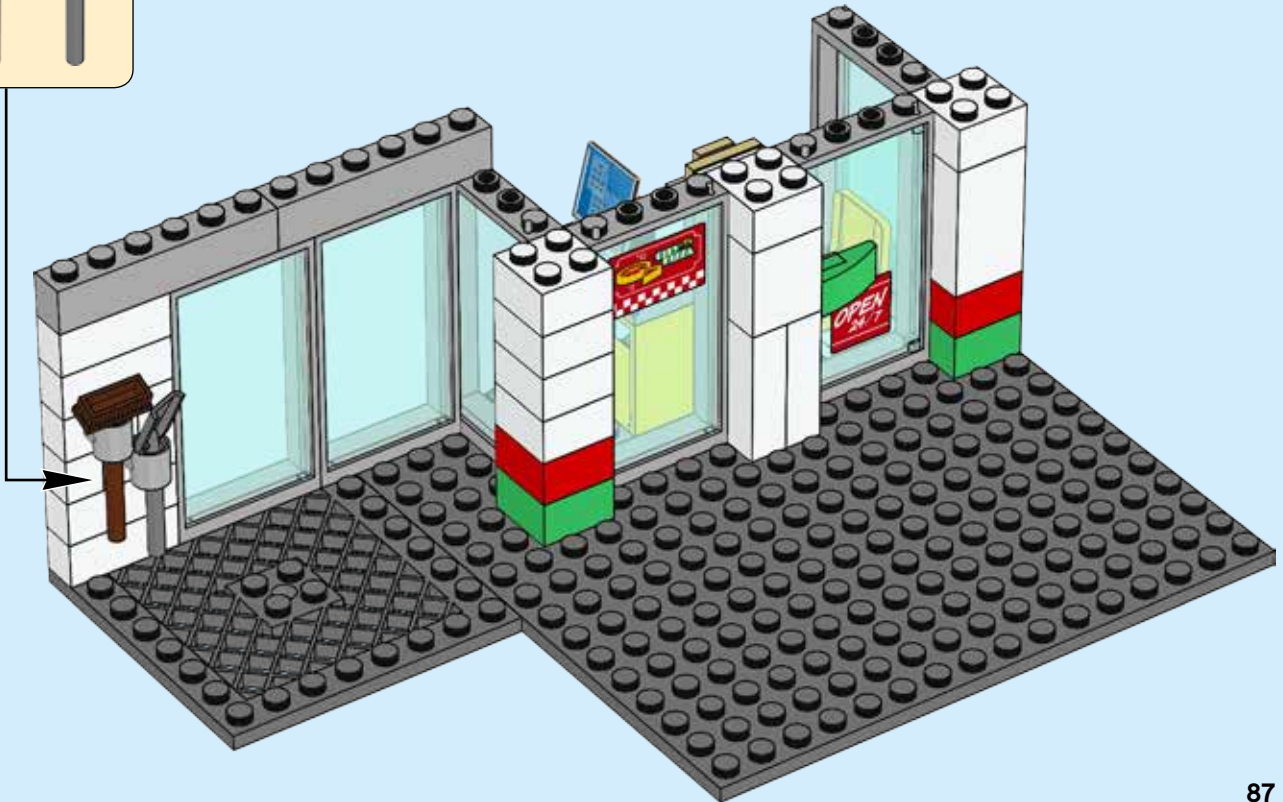

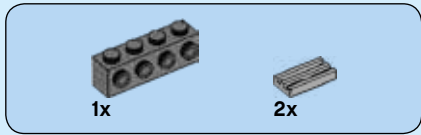

# 23

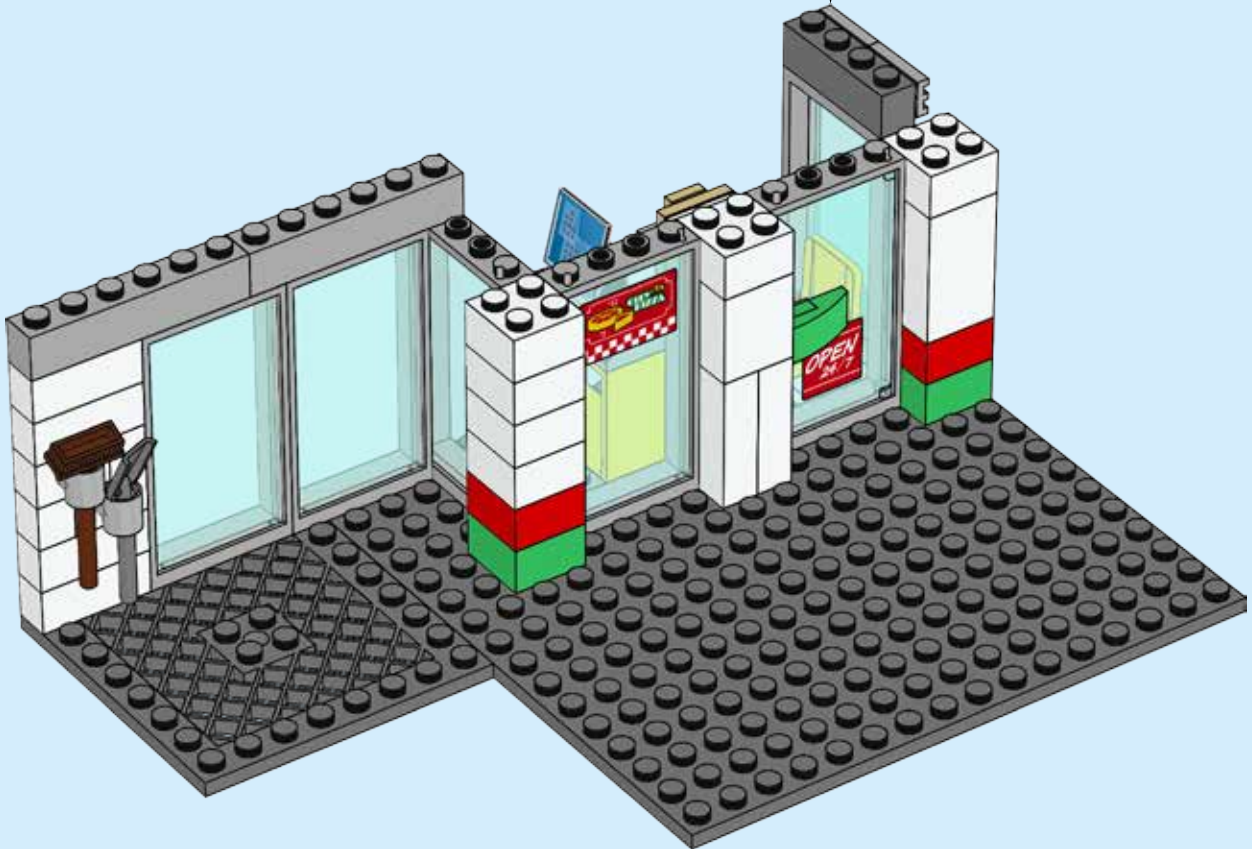
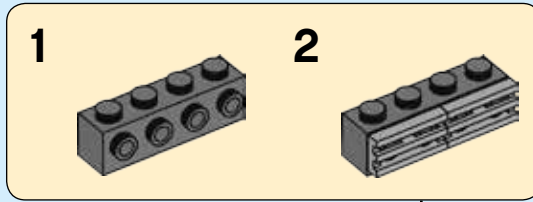



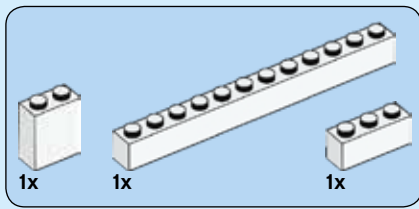

# 24

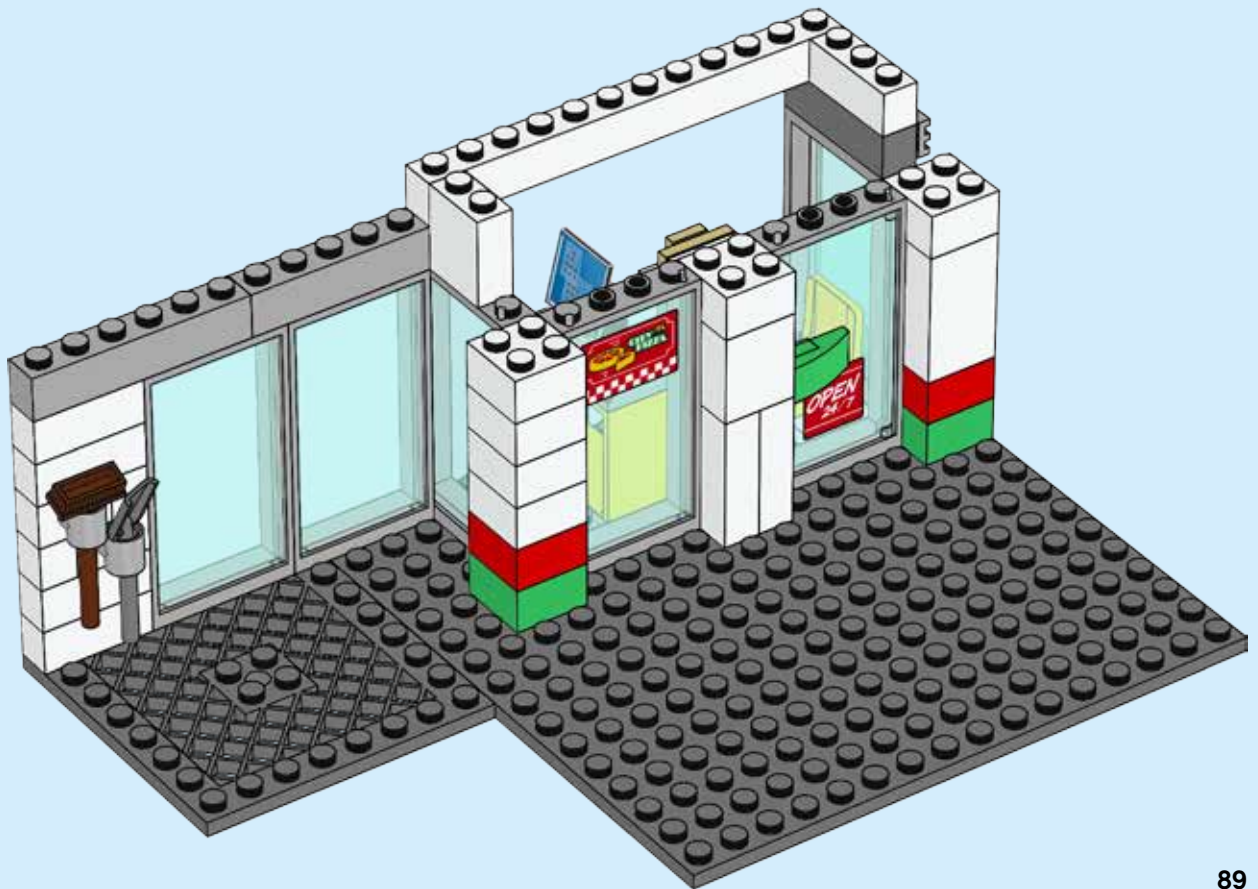



2x

# 25

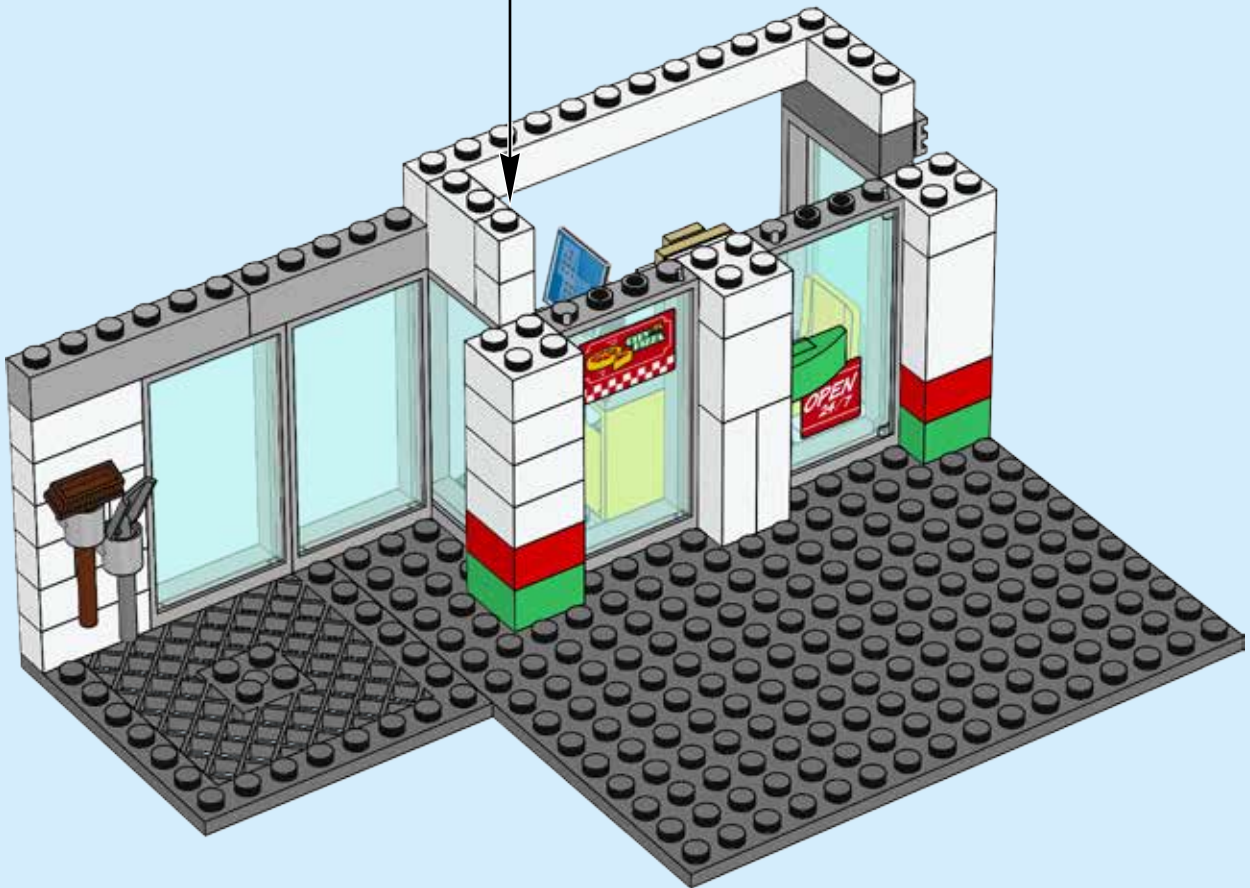
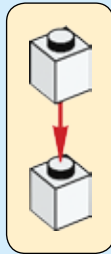

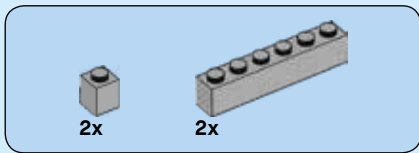

26

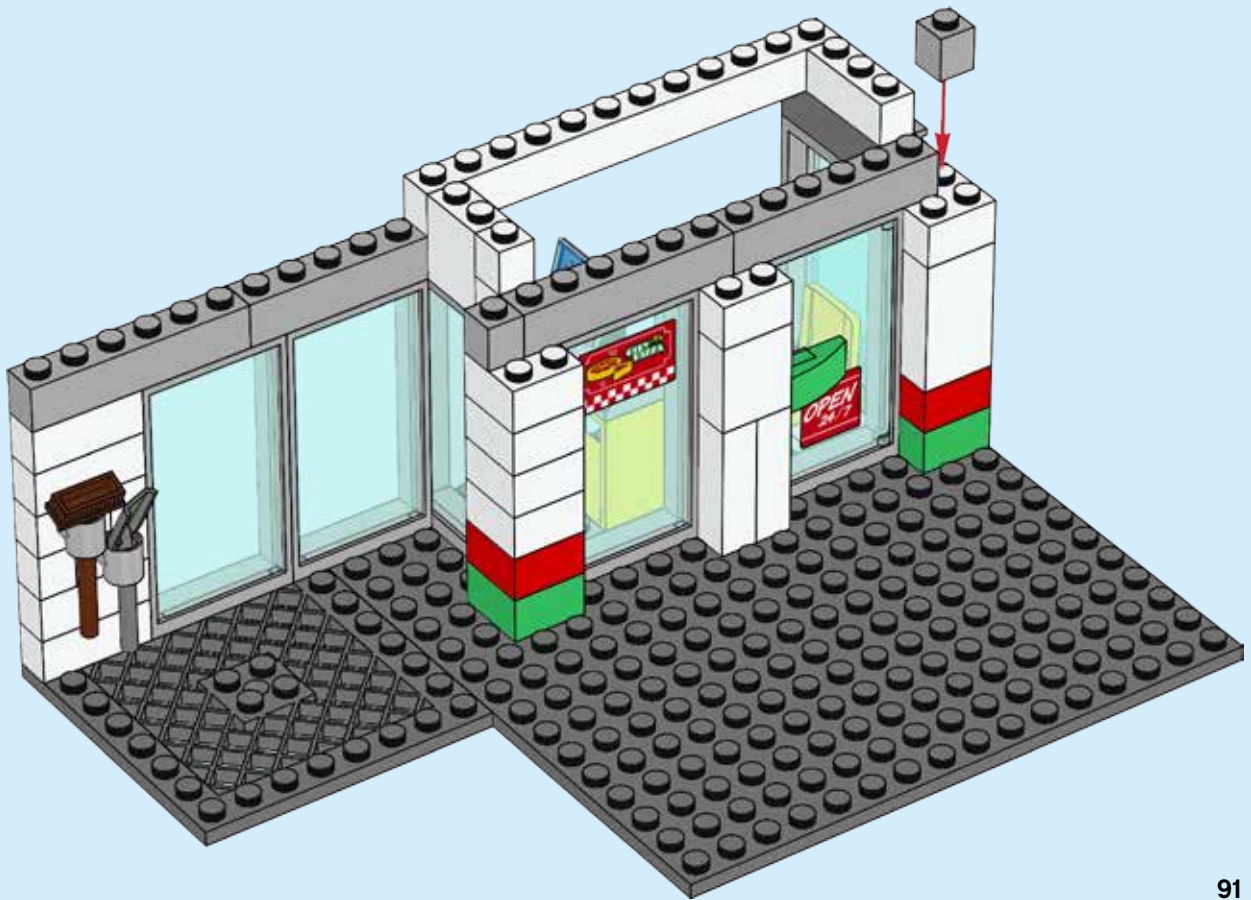



3x

# 27

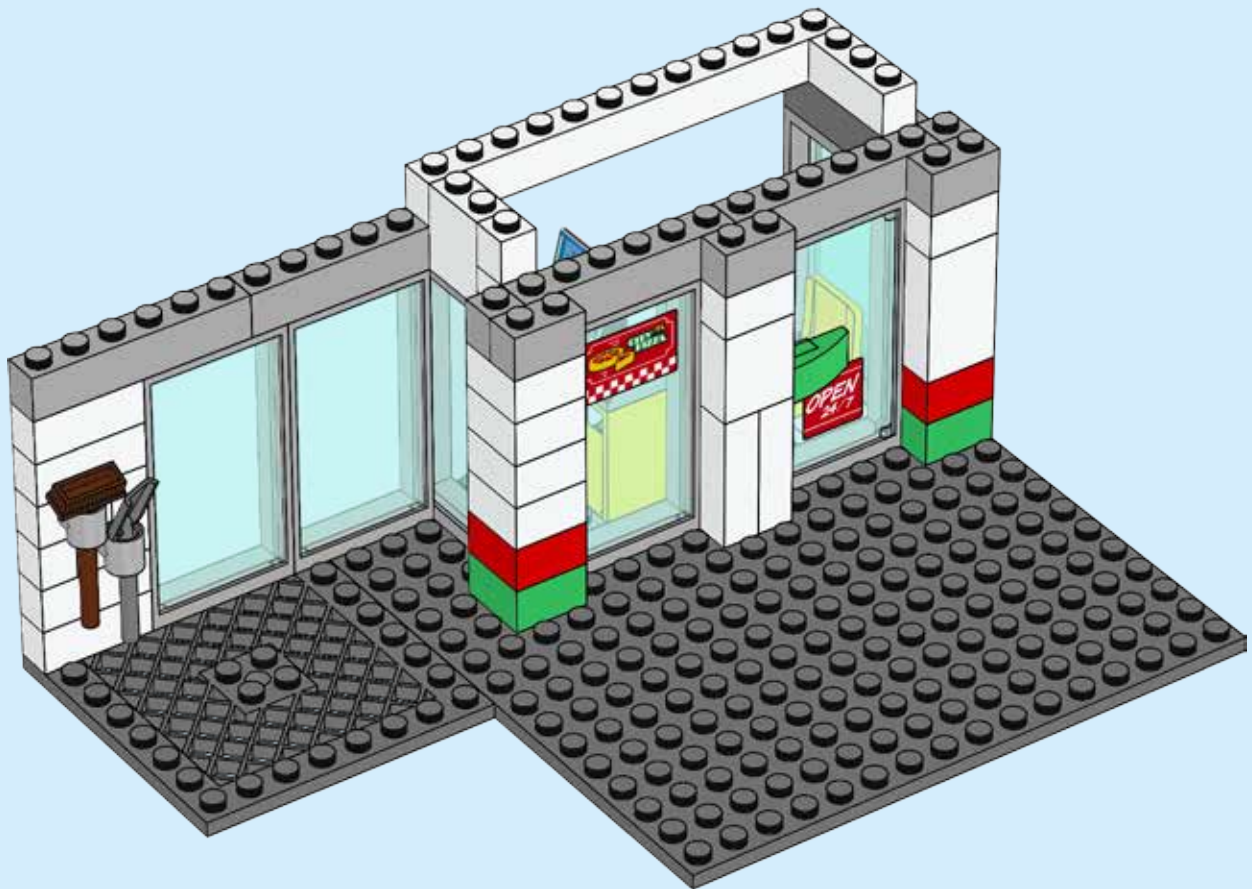

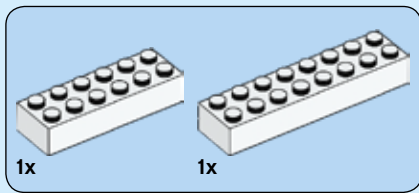

# 28

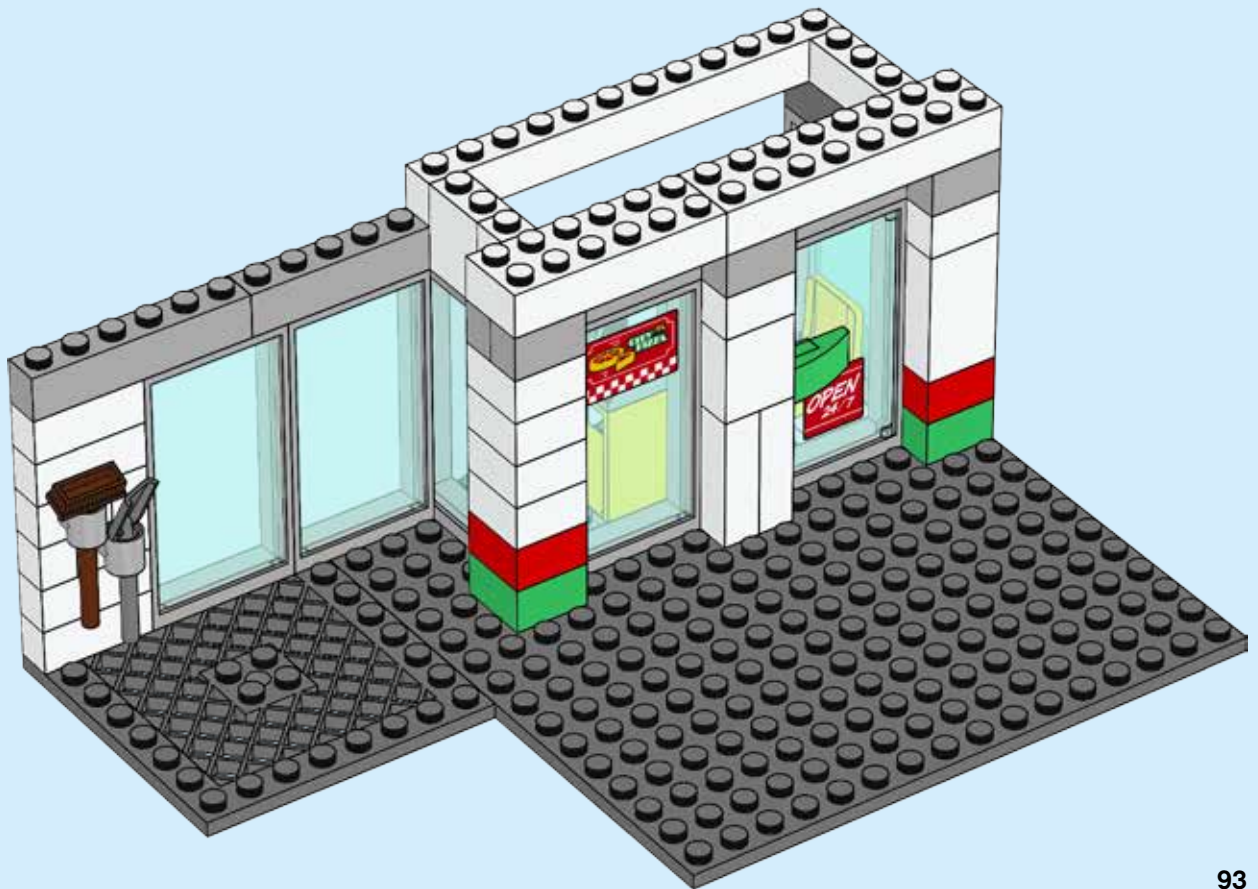

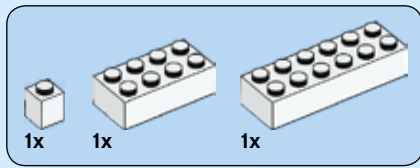

# 29

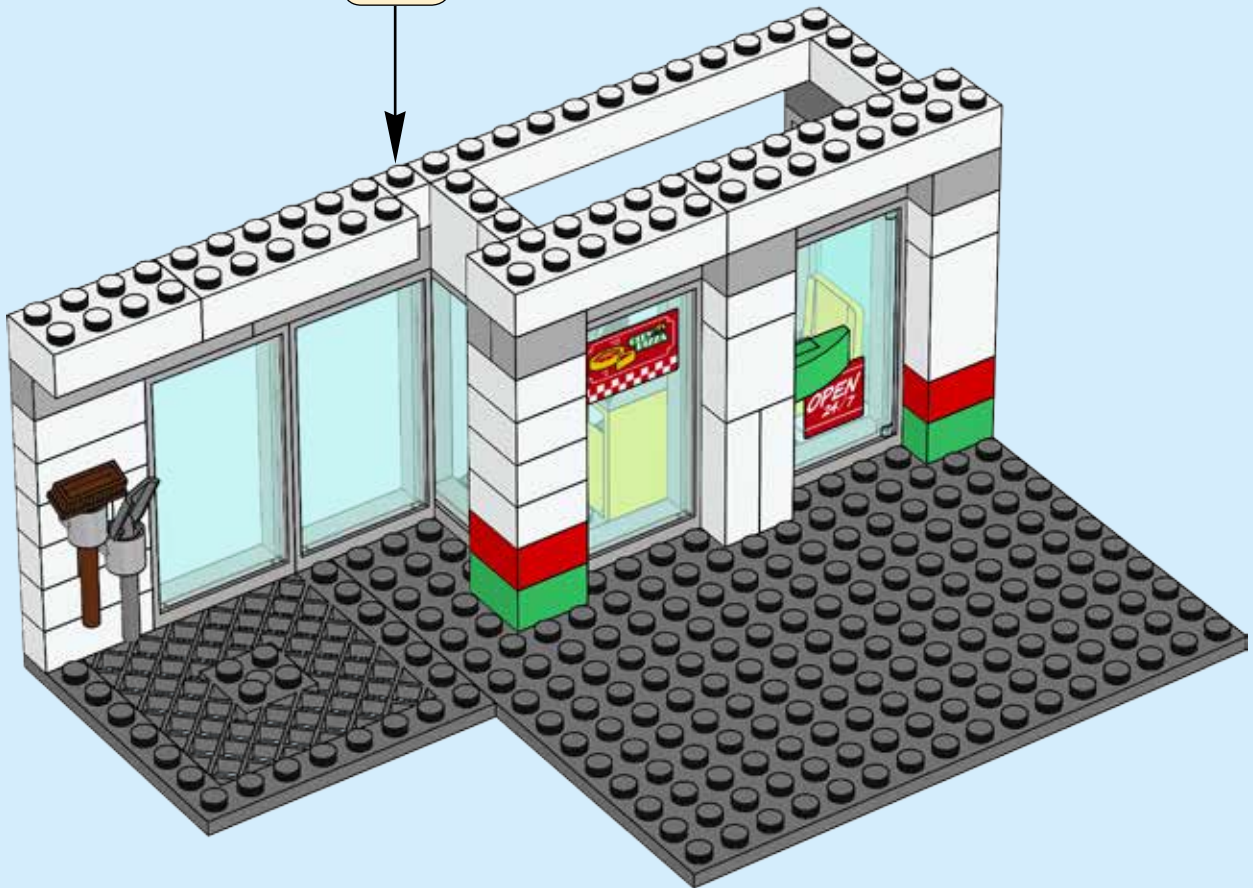

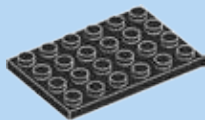

4x

# 30

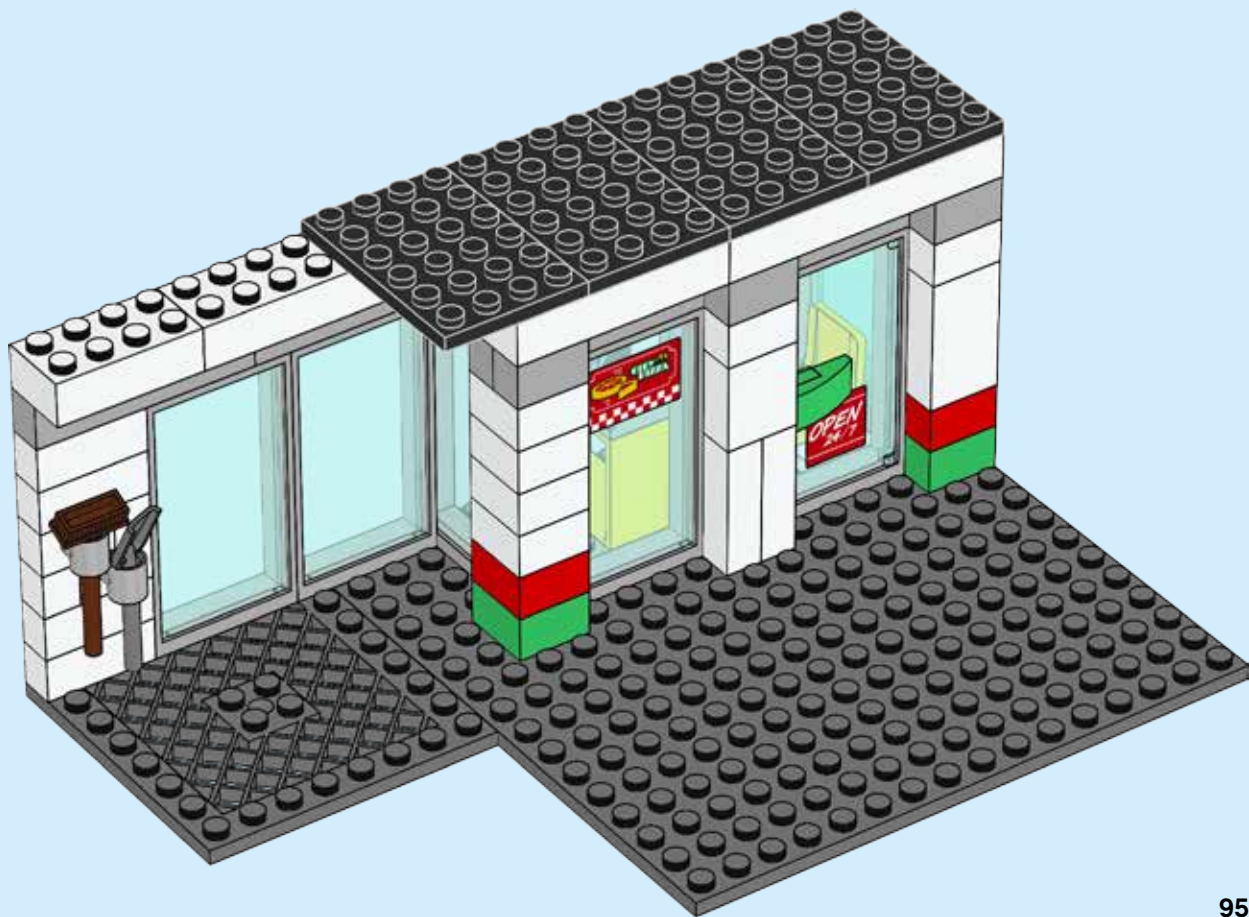

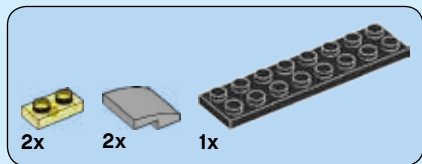

# 31

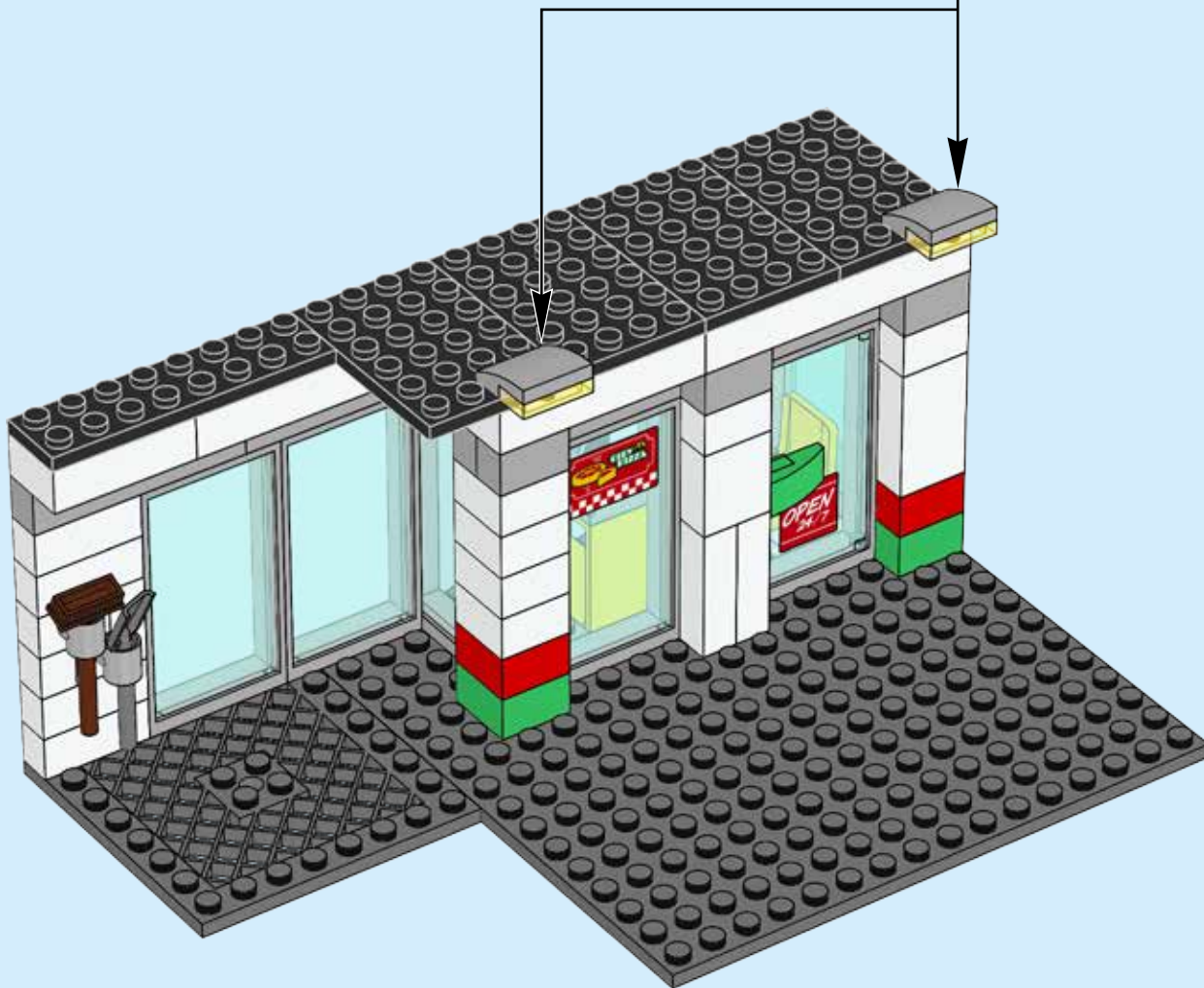
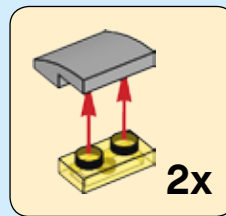



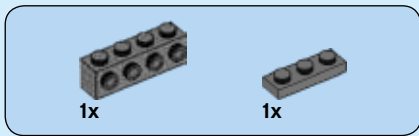

# 32

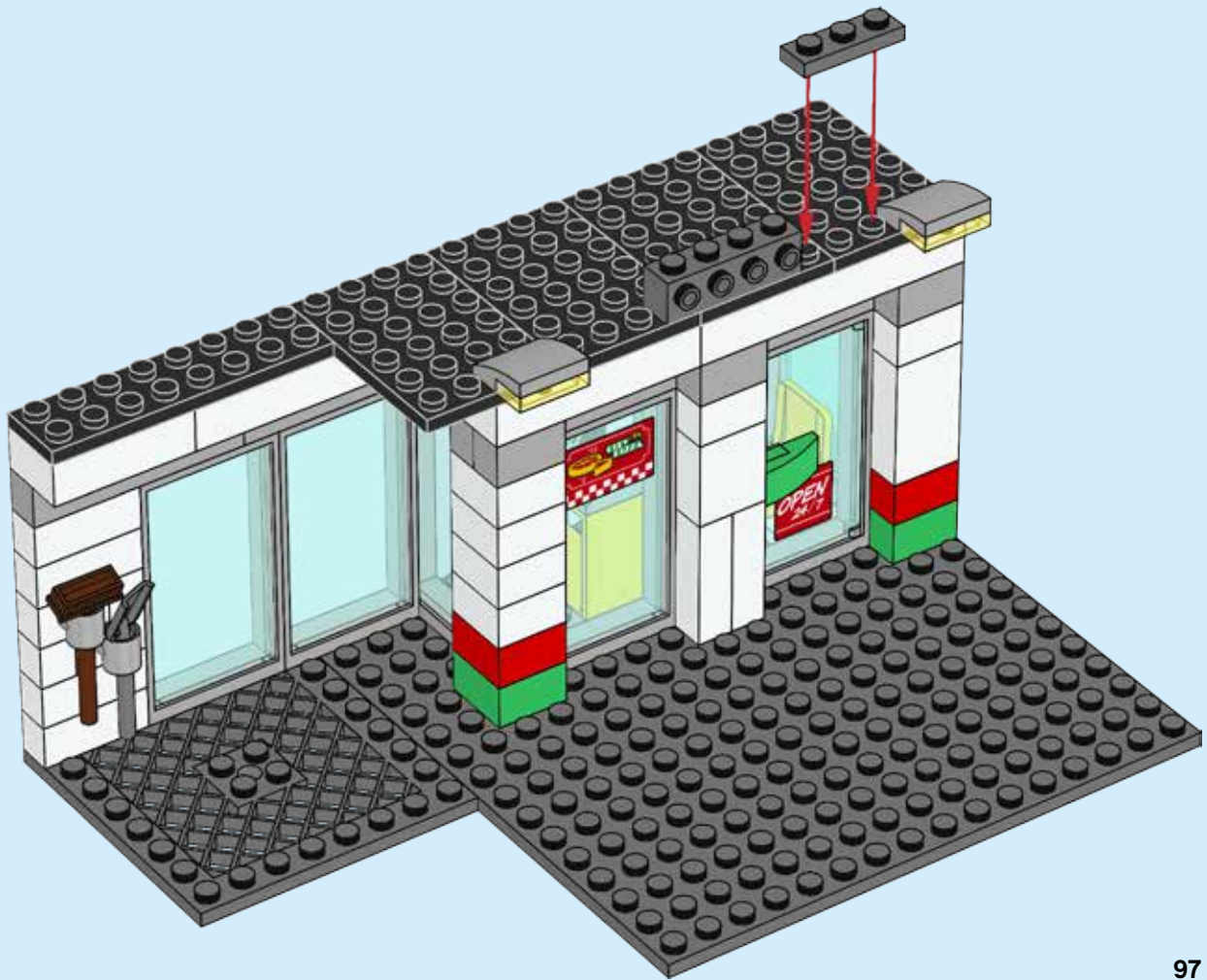

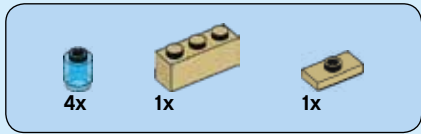

# 33

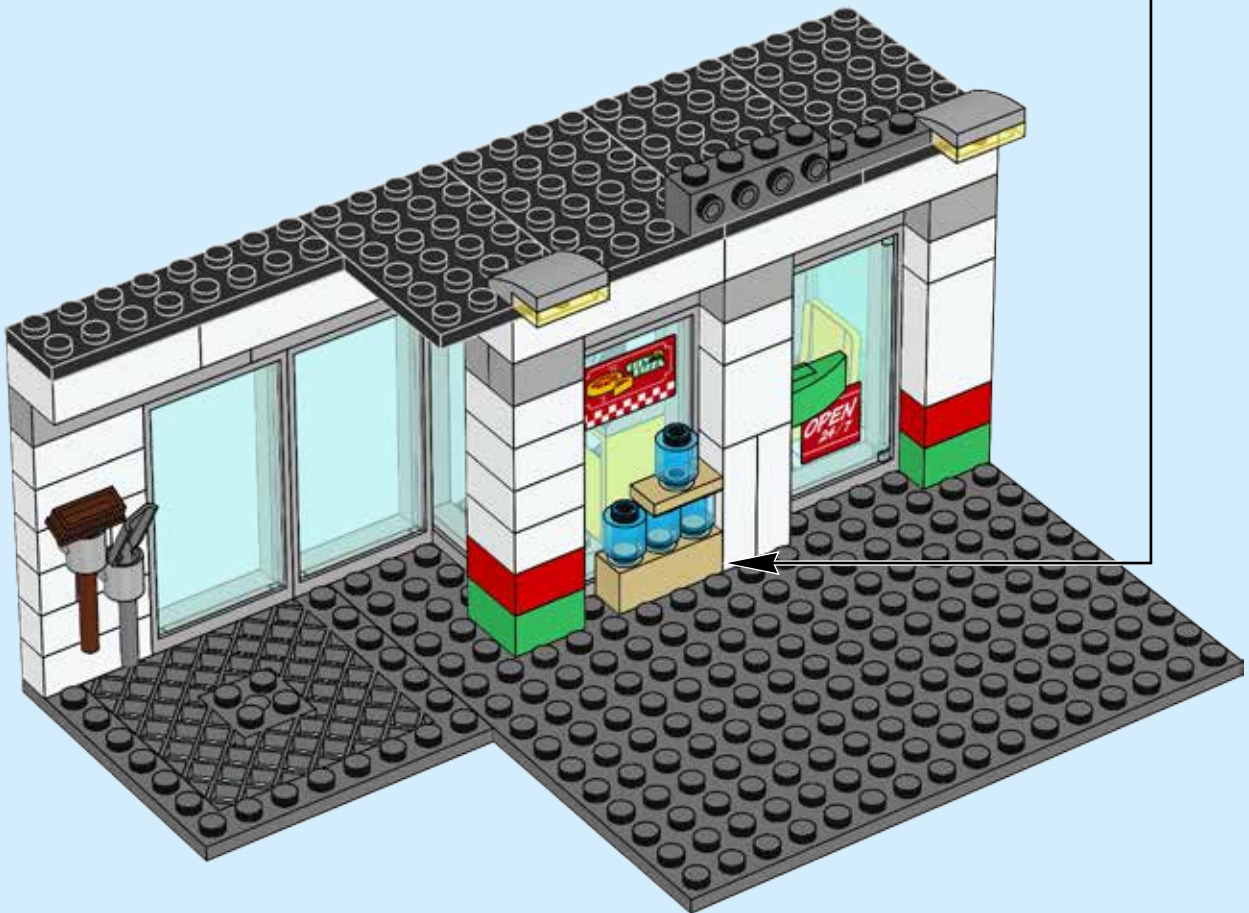
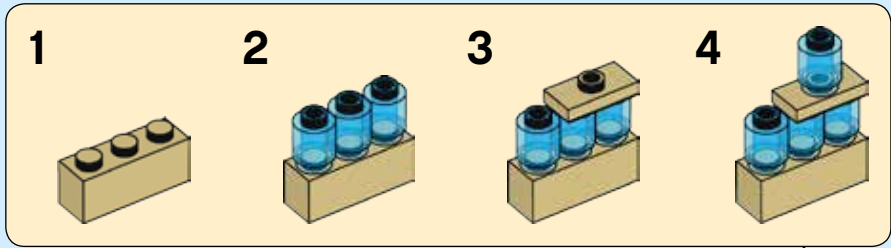

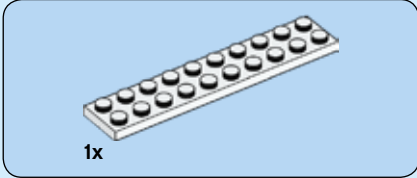

34

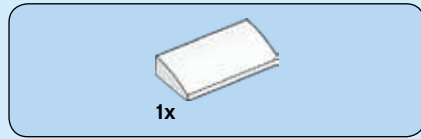
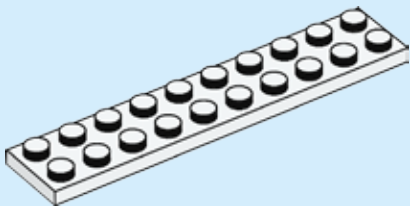

35

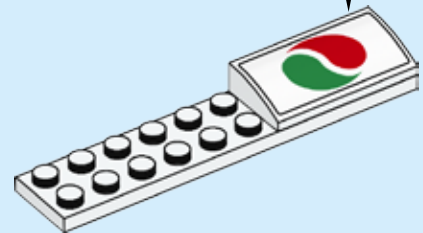
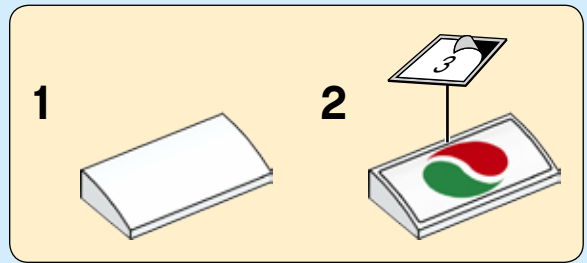

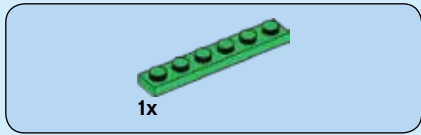

36

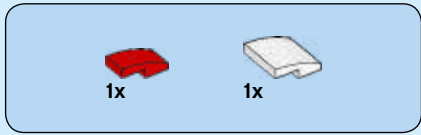
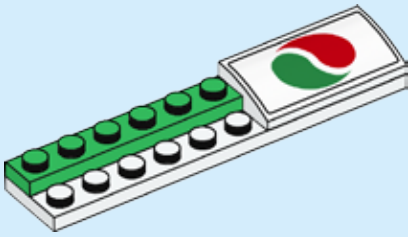

37

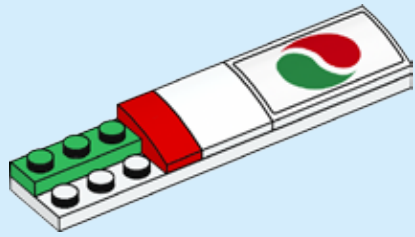

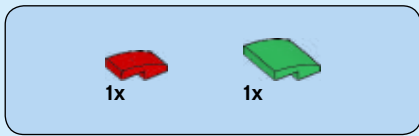

# 38

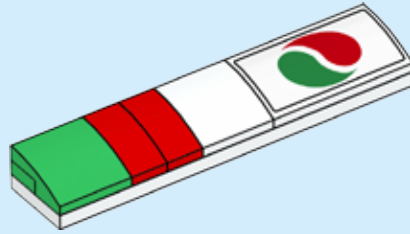

# 39



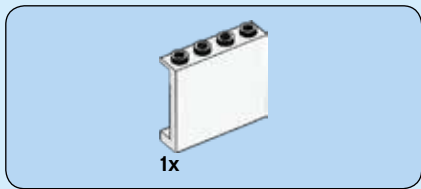

40

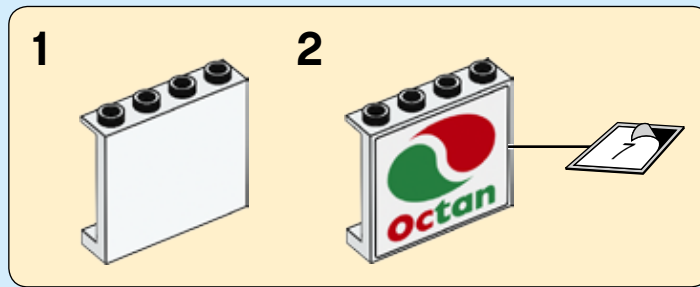

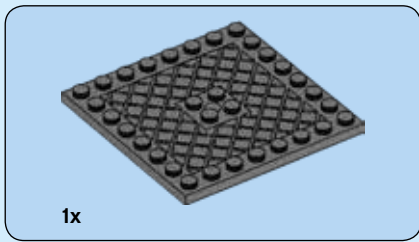

# 41



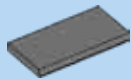

1x

# 42

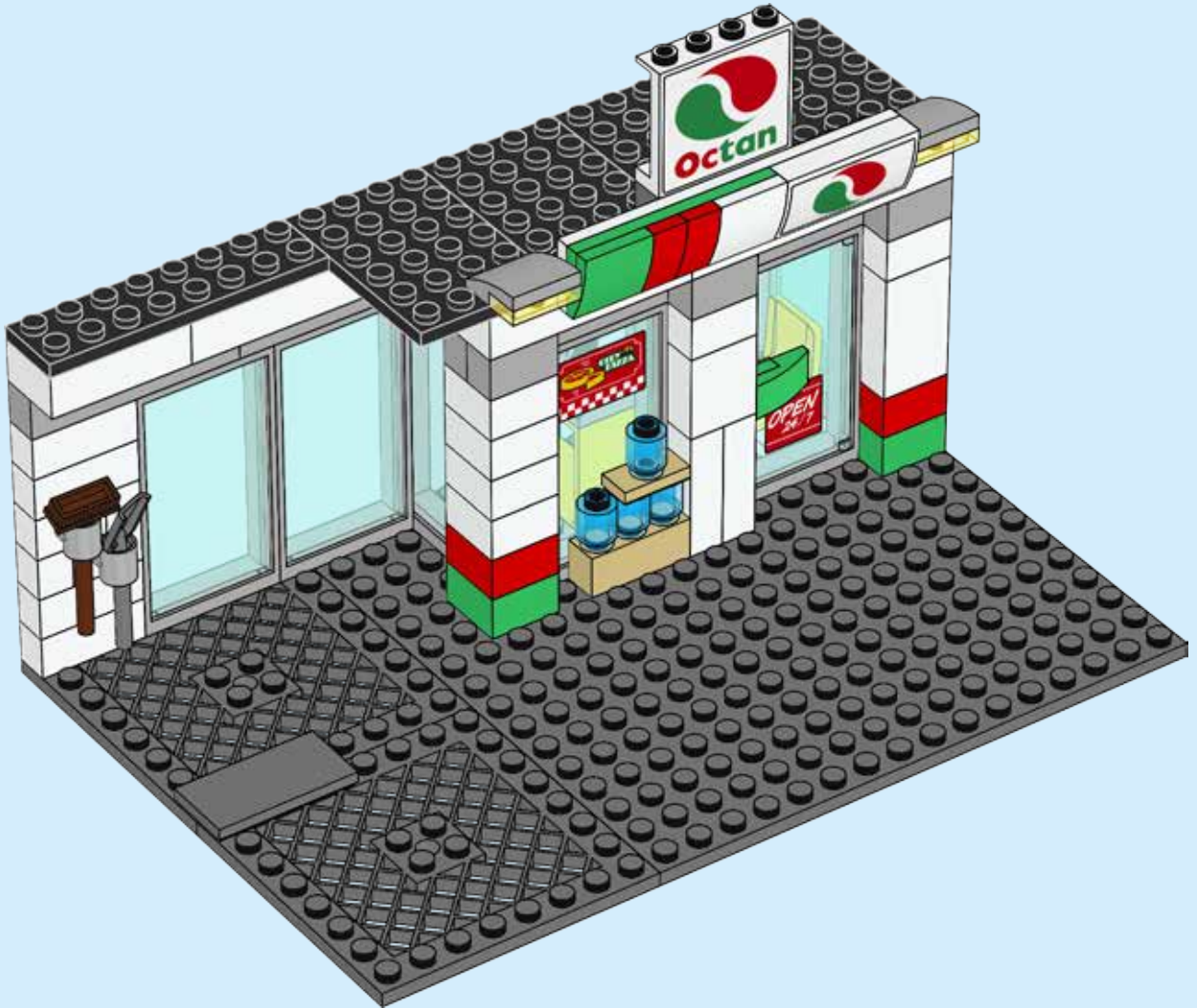



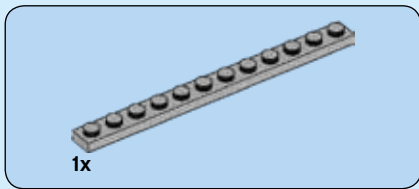

# 43



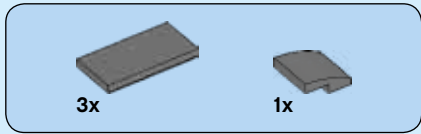

44





# 45

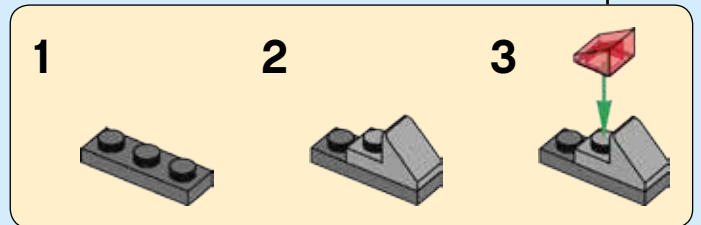

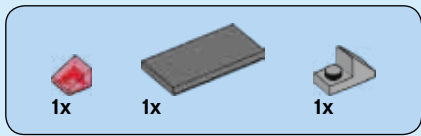

# 46



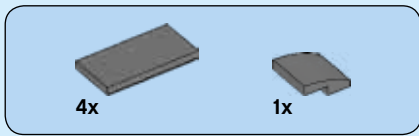

# 47

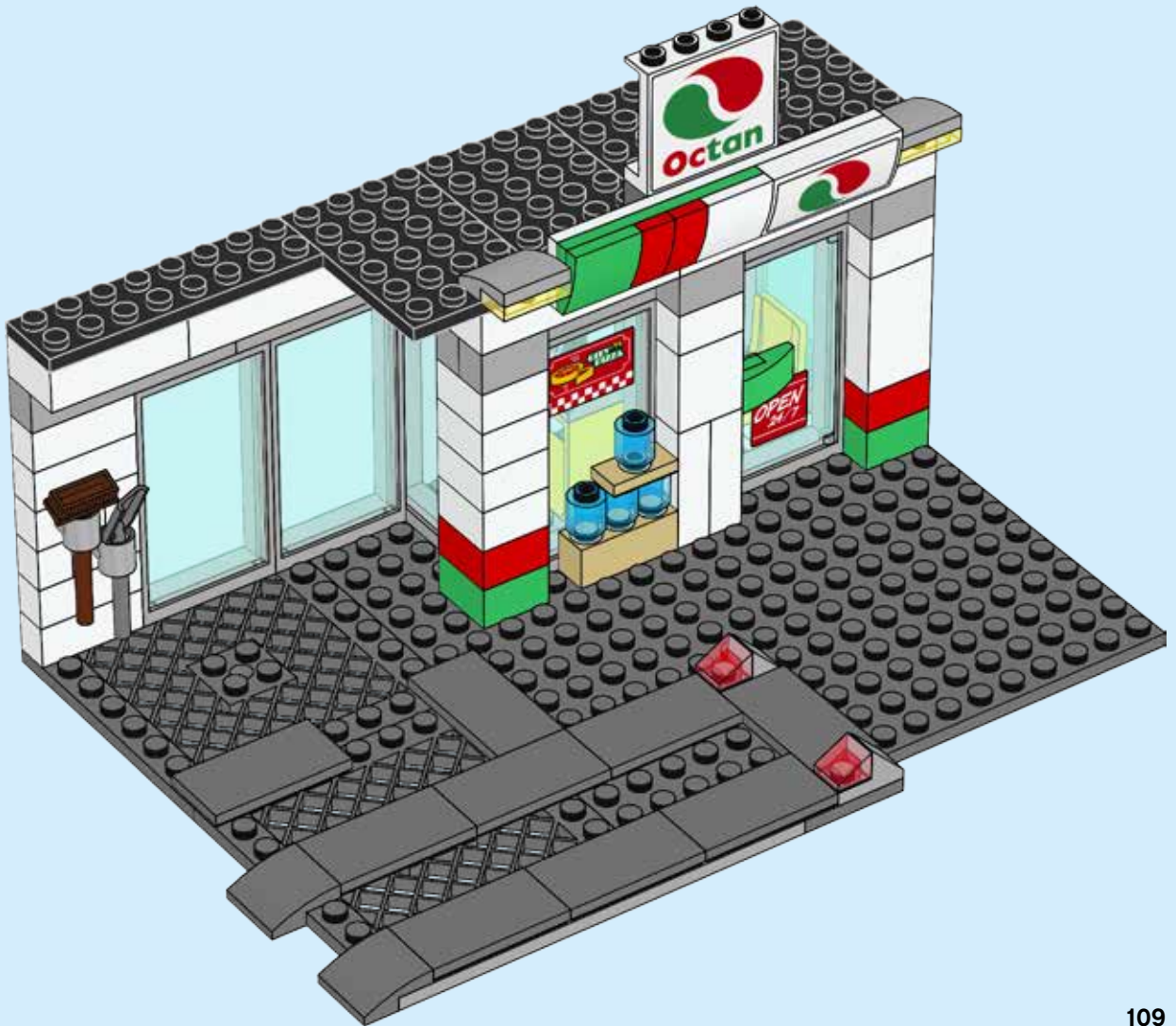



1x

# 48

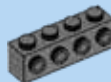

2x

# 49

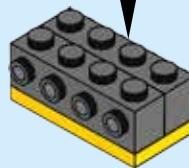
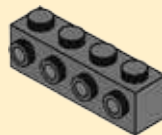



1x



2x

# 50

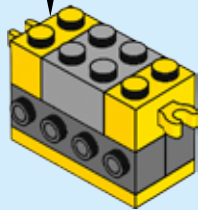
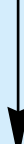
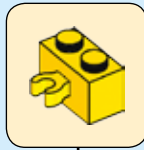

1x

# 51

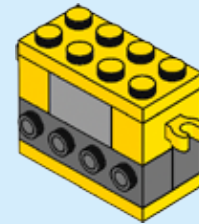

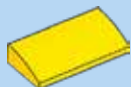

1x

# 52

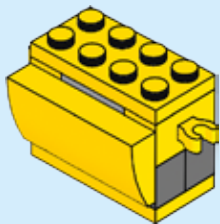

1x



1x

# 53





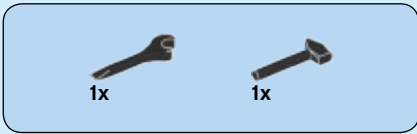

# 54

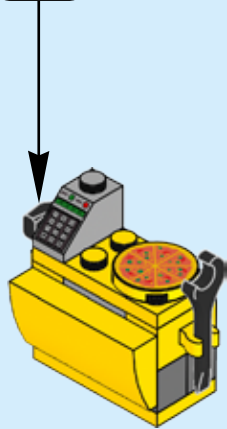

# 55

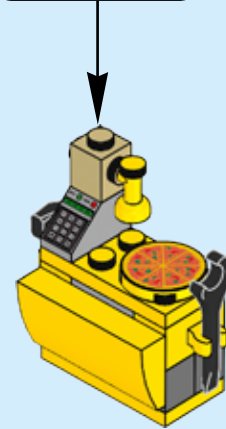
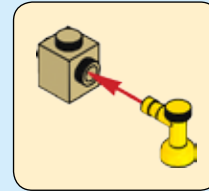

56





2x



1x

# 57



1



2



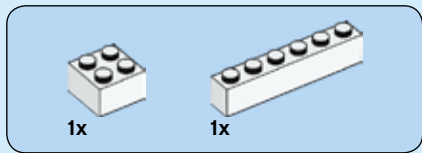

# 58

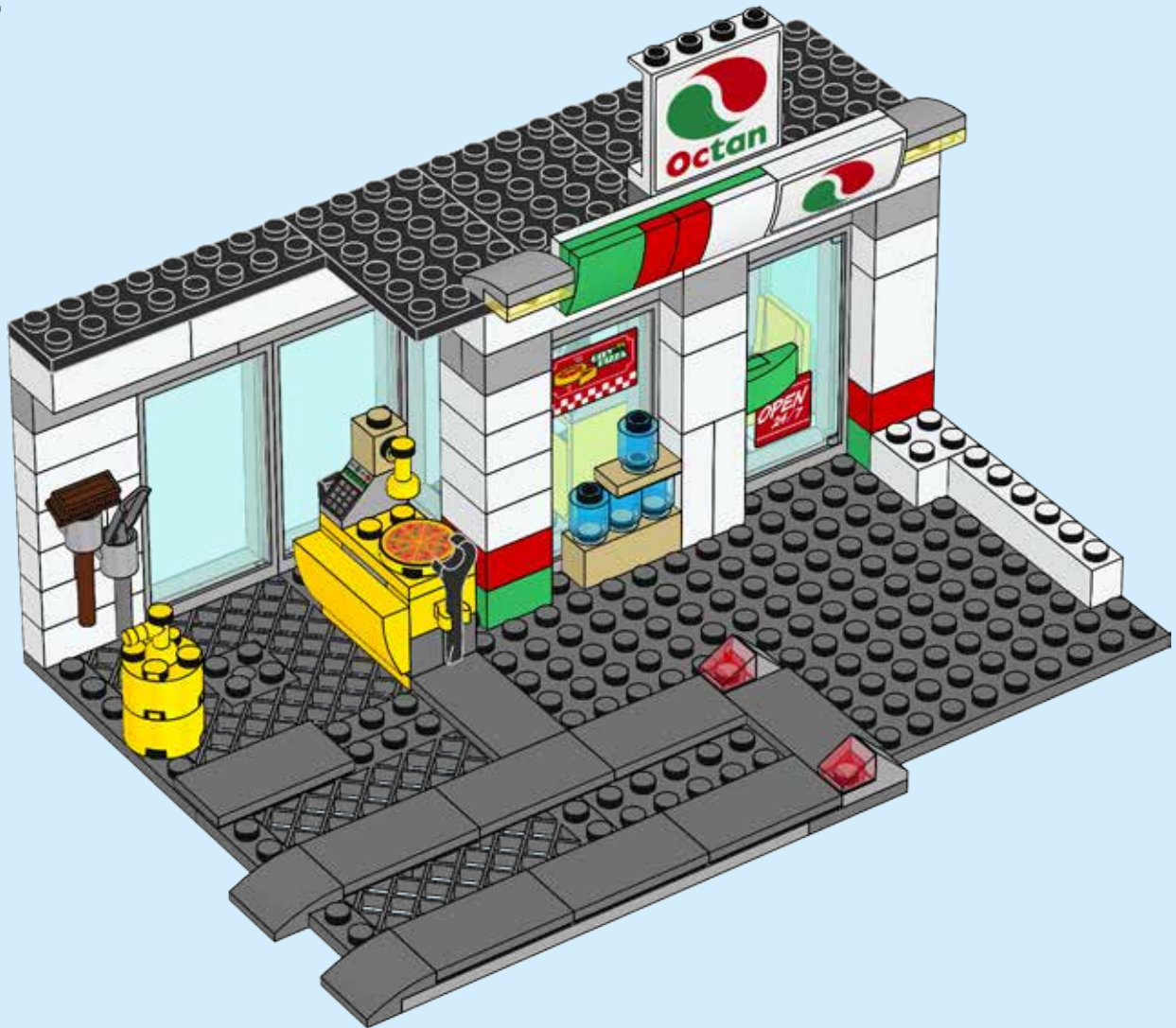

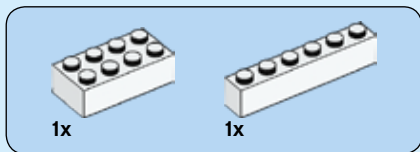

# 59

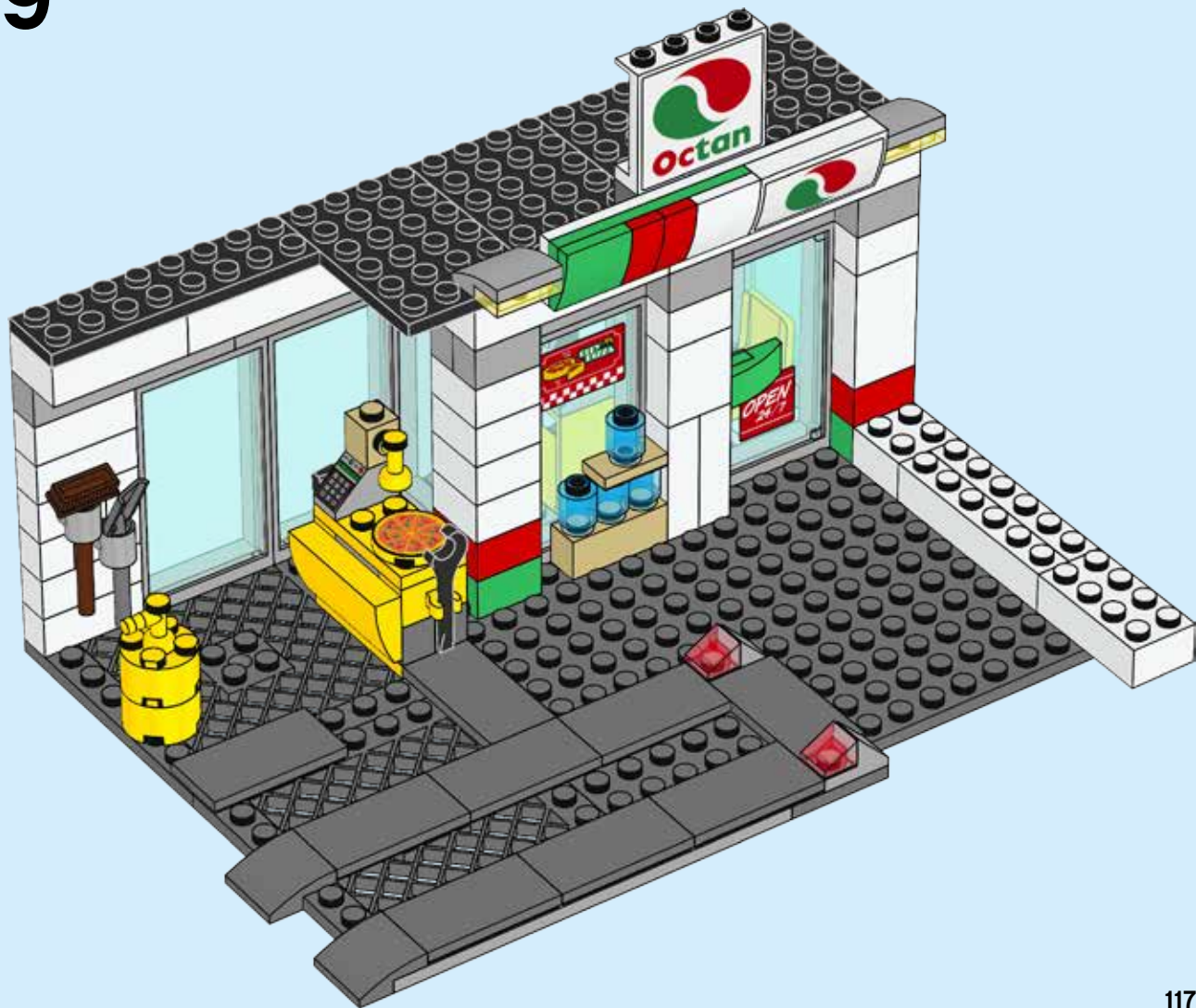

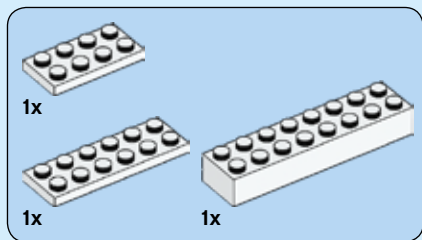

# 60

## 1

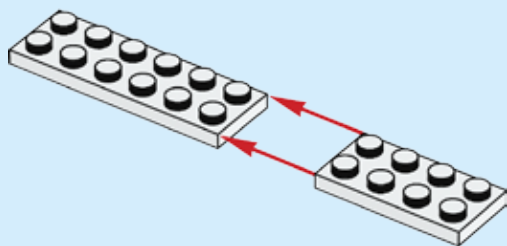

## 2

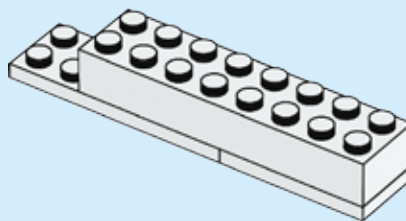

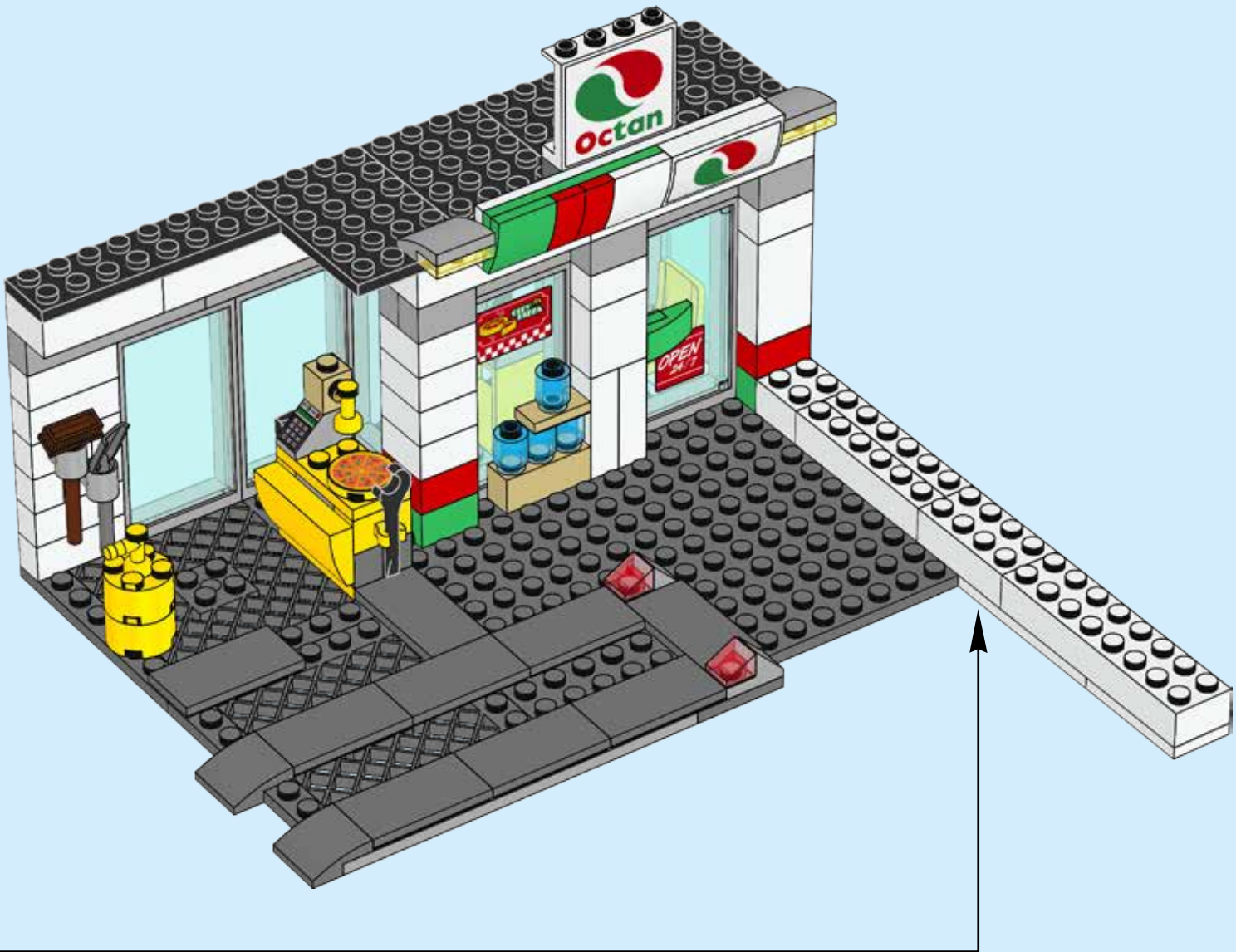

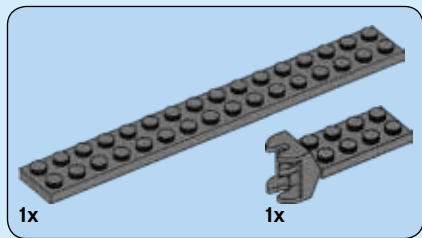

# 61

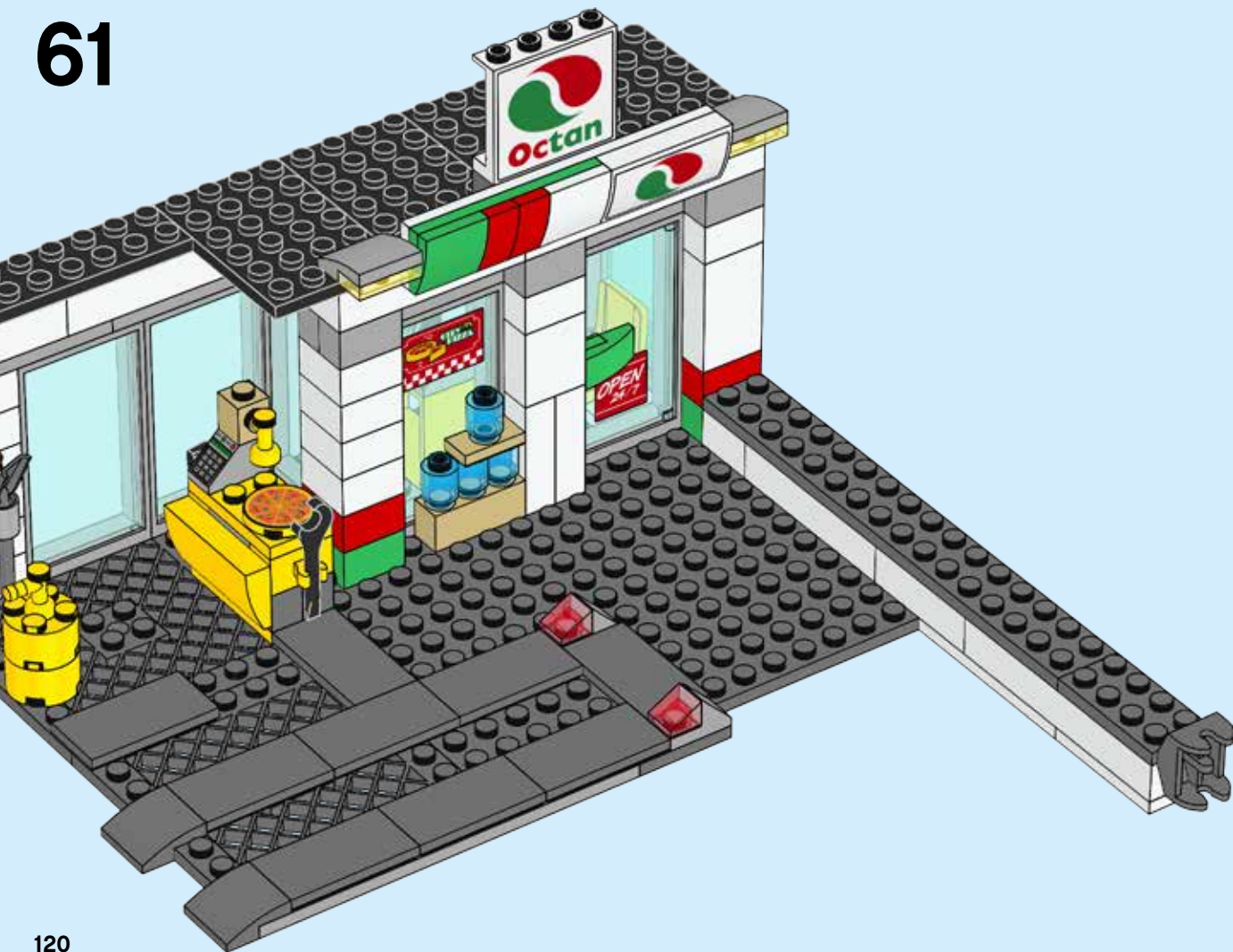





5x

# 62

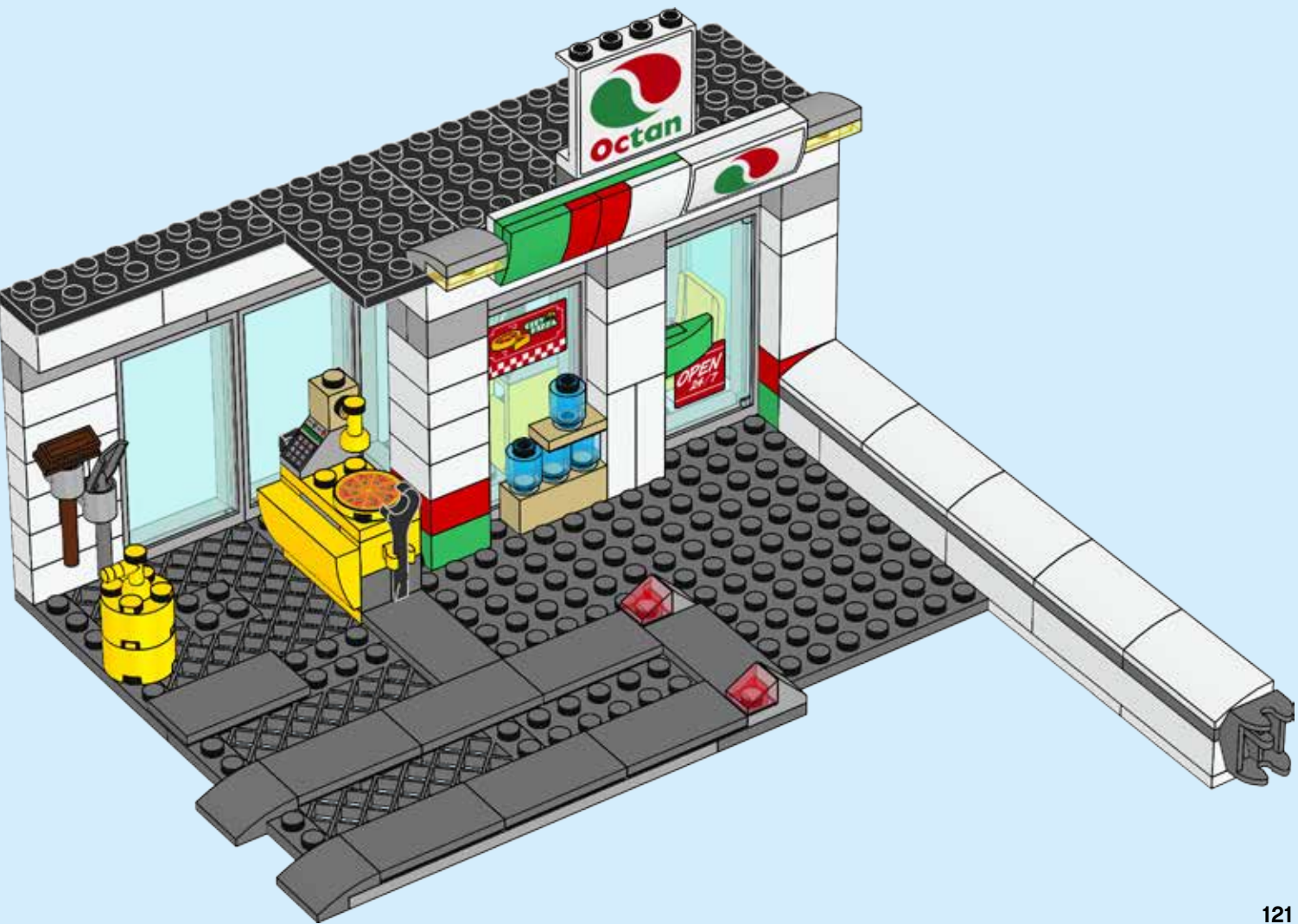

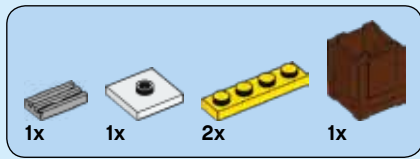

63

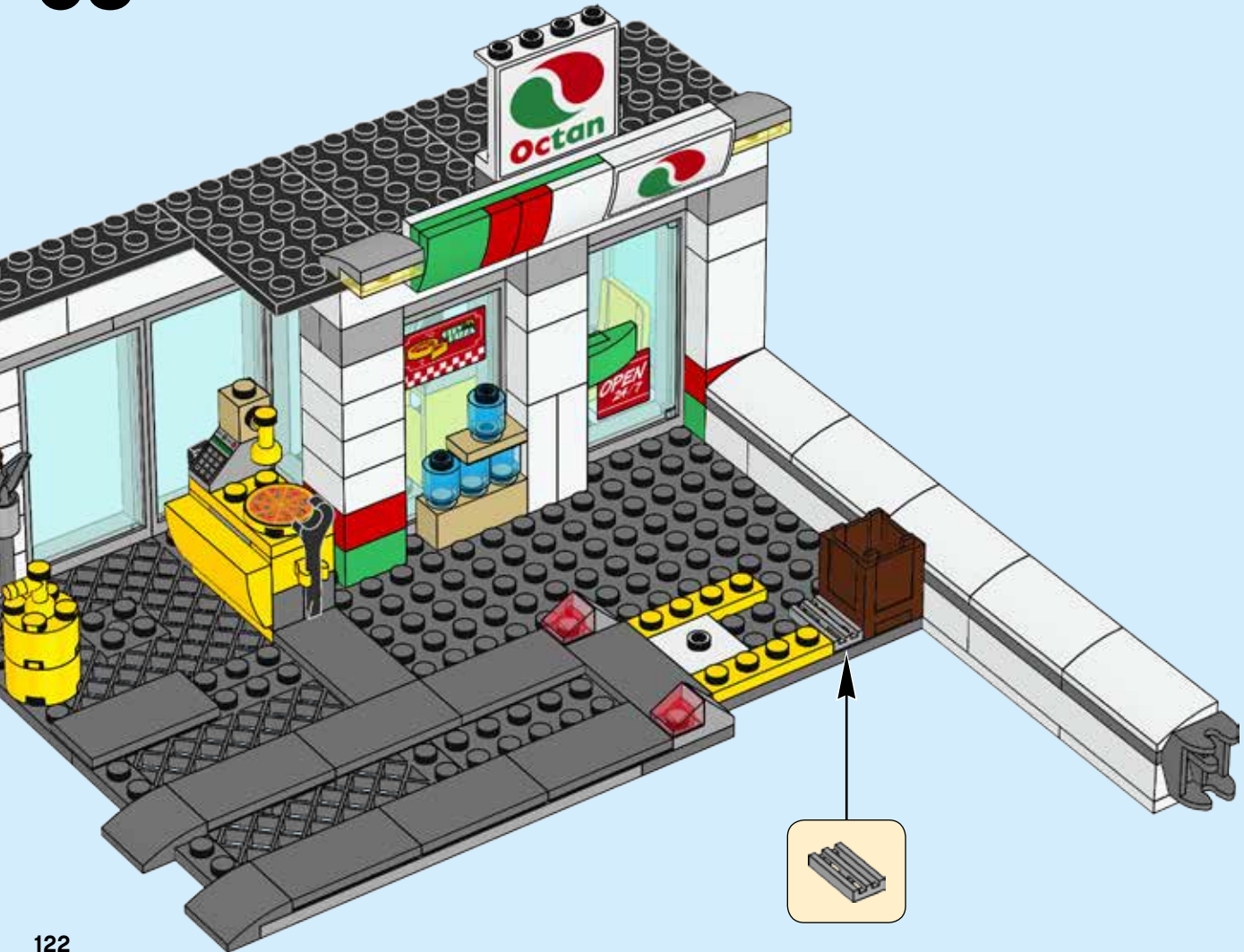

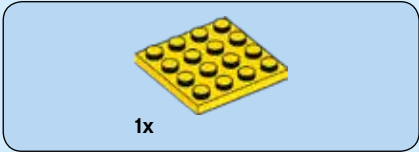

64

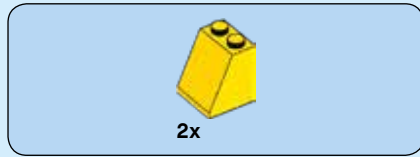
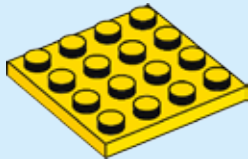

65

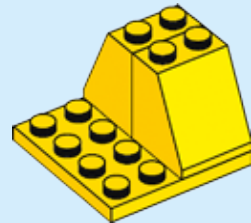



2x

66

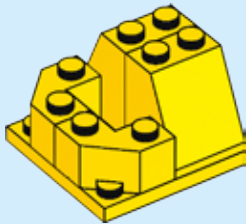

1x

67

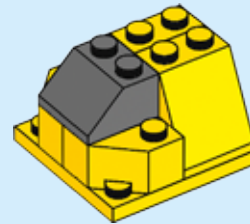

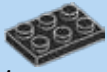

1x



1x



1x

# 68

1

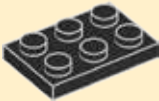

2



3

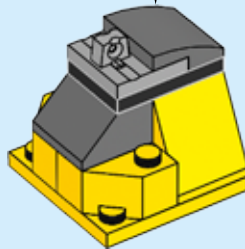

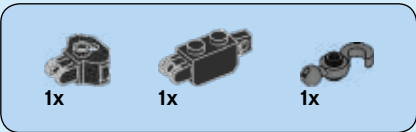

# 69

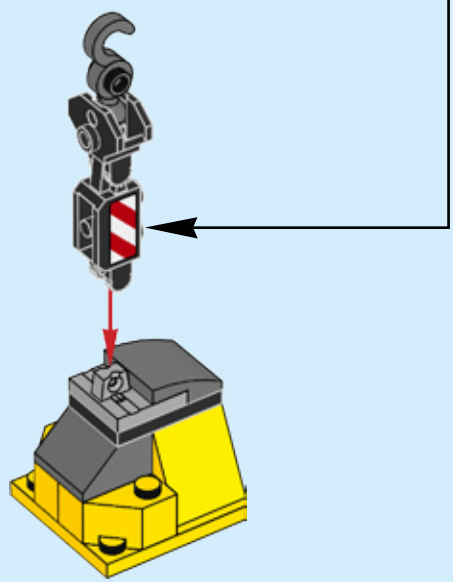
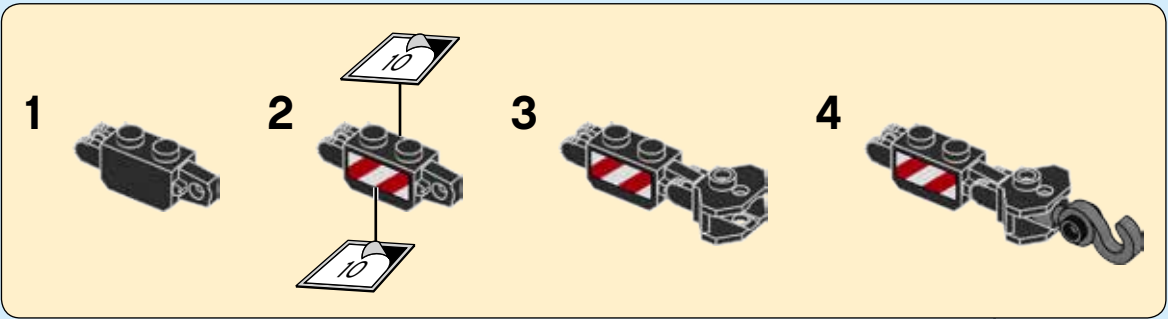

70

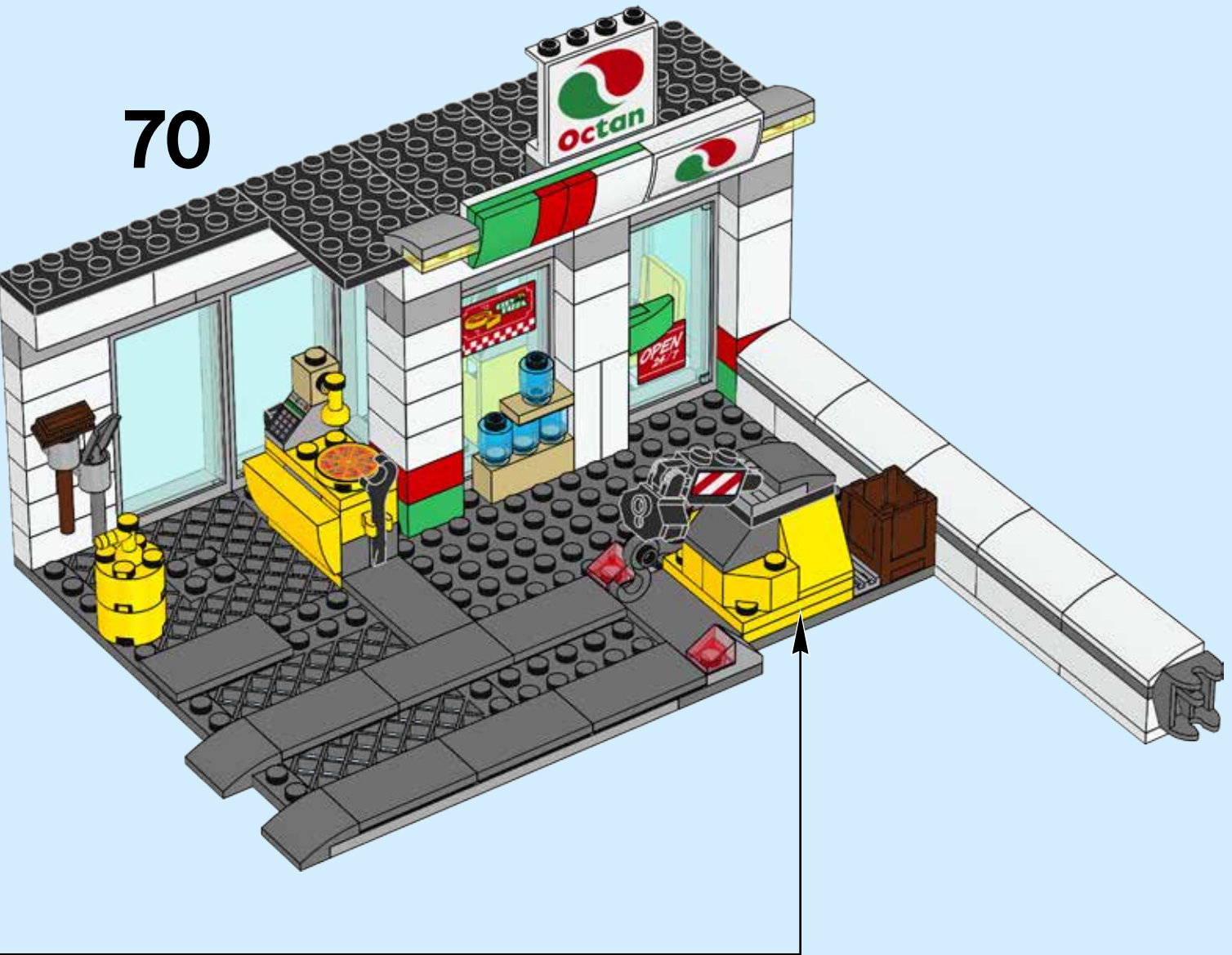

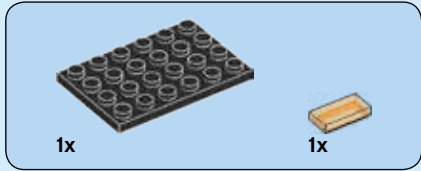
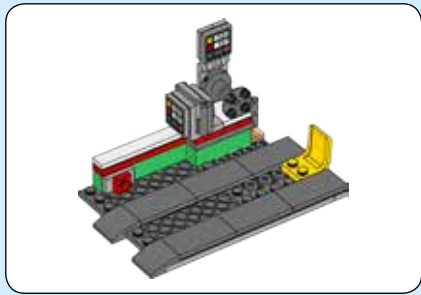

71

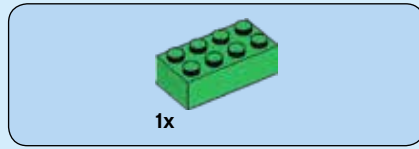
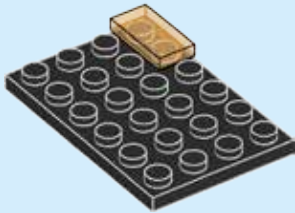

72

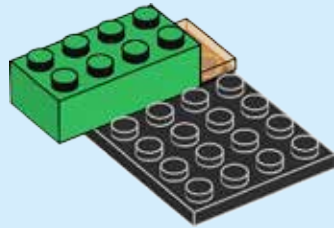



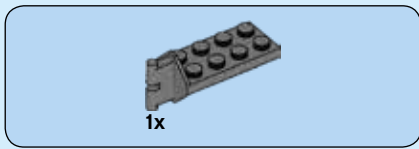

73

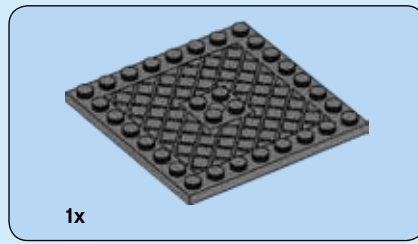
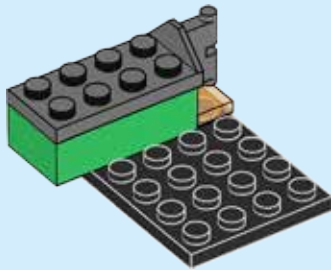

74

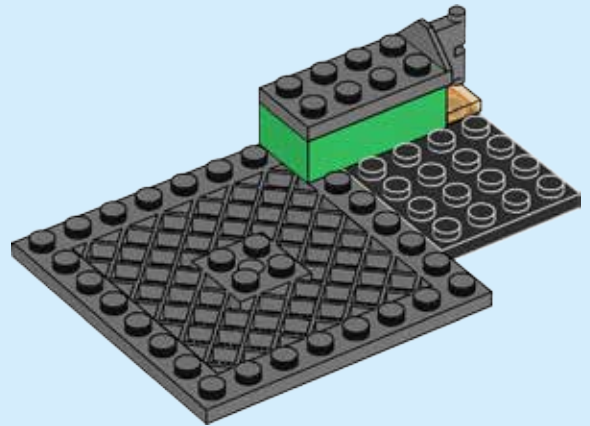



# 75

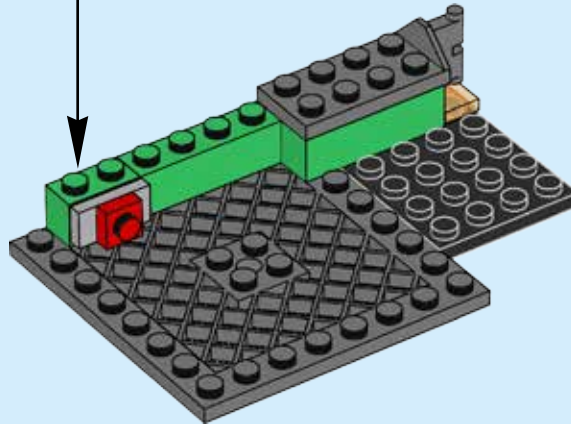
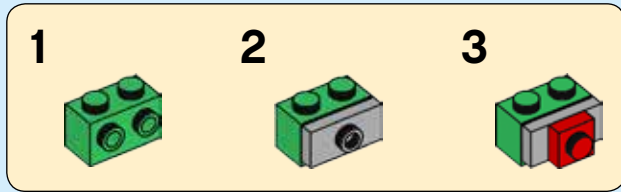

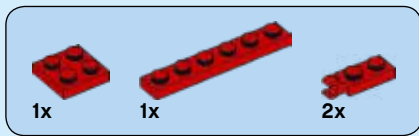

# 76

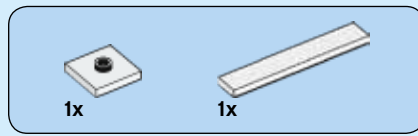
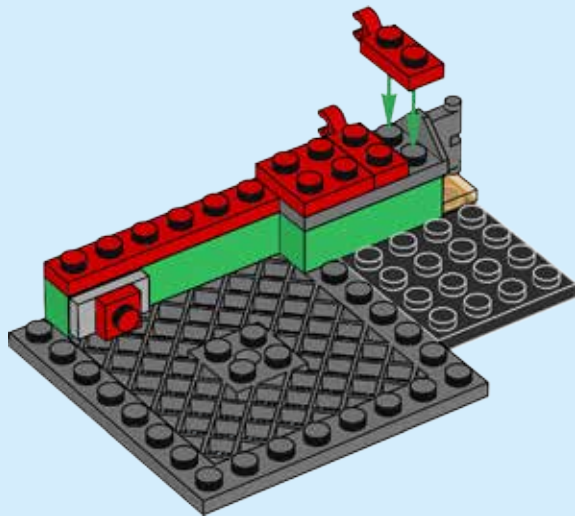

# 77

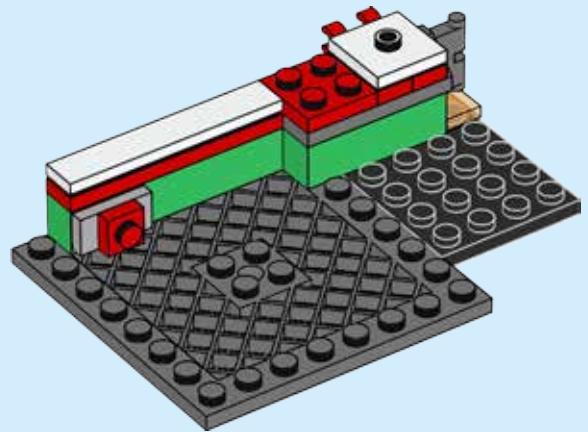

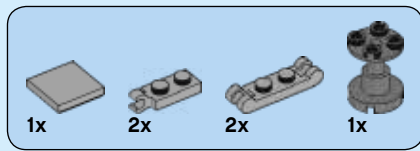

# 78

1

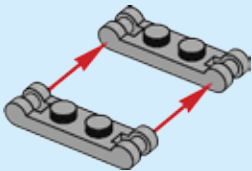

2



3

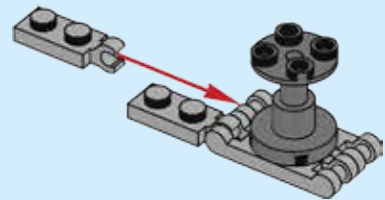

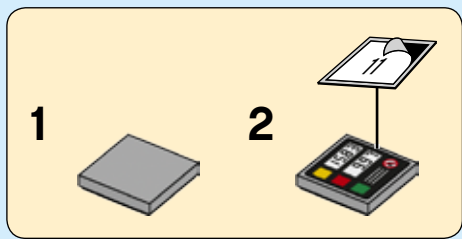

4

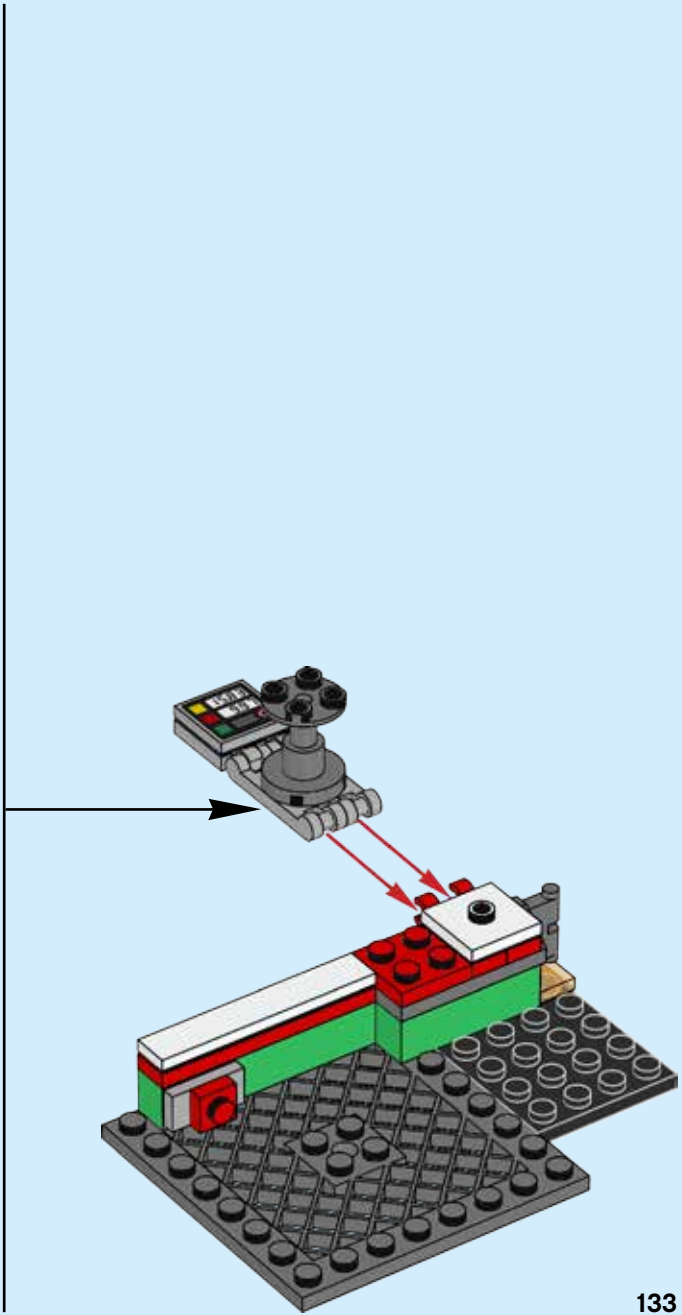
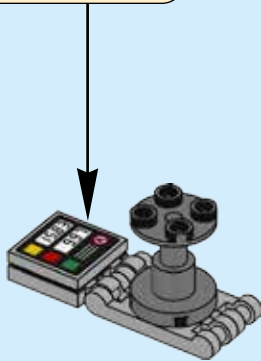

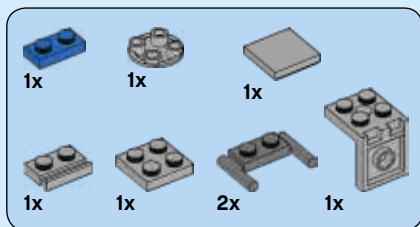

79

1



2



**3**



**4**

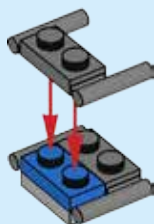

**5**

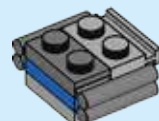

6

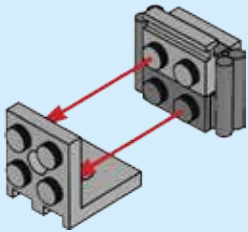

7

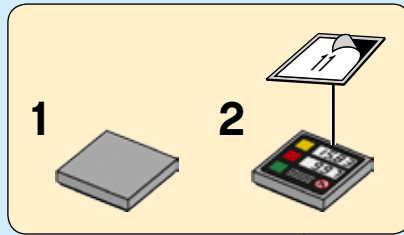

8

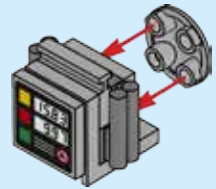
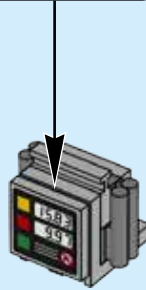



80

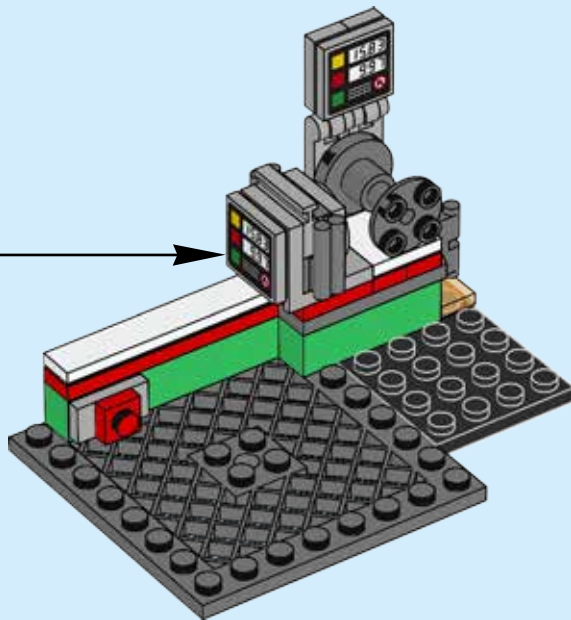

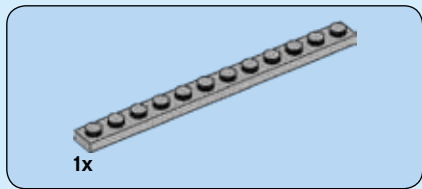

# 81

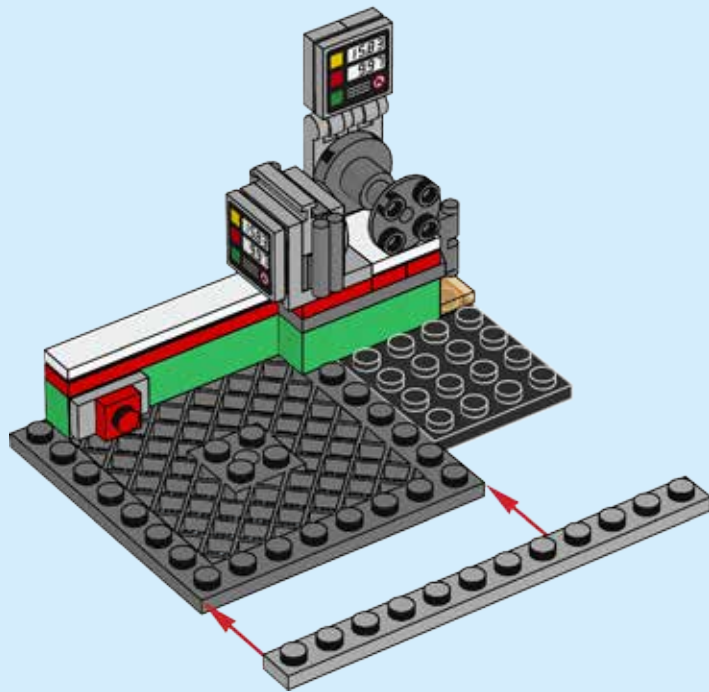



1x

# 82

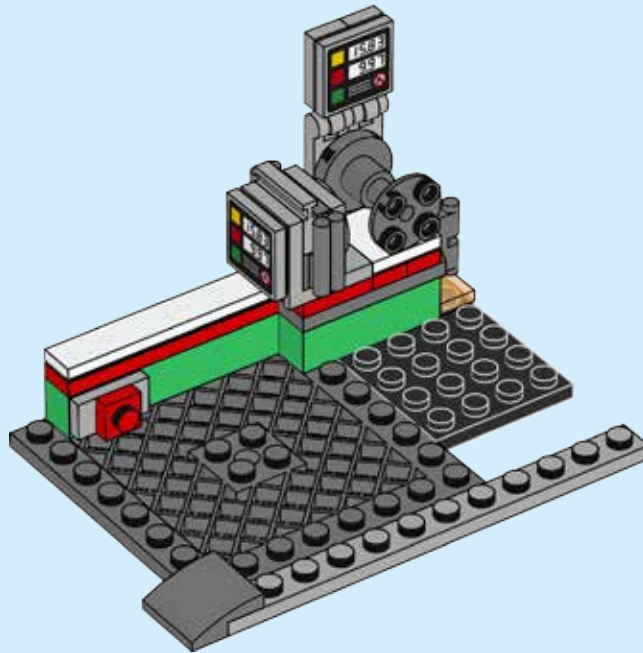



1x

# 83

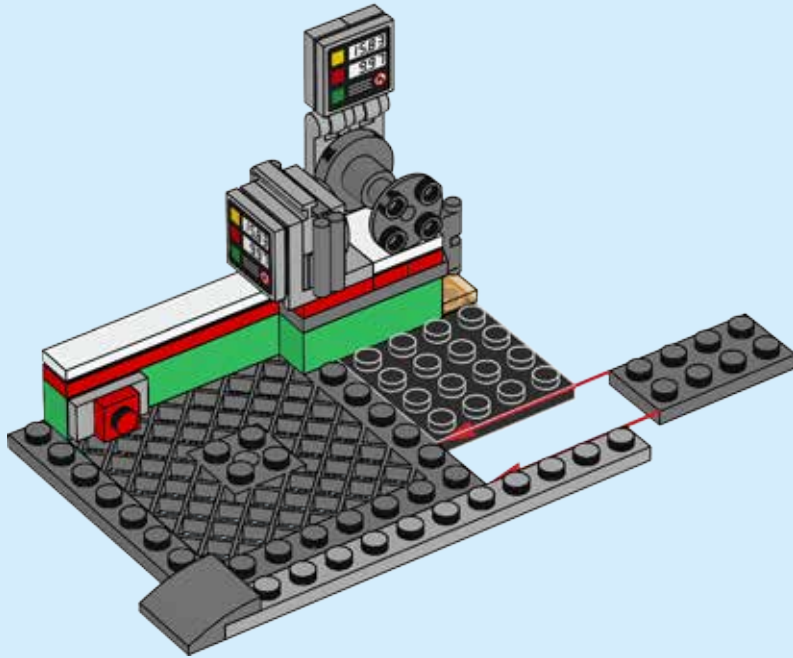

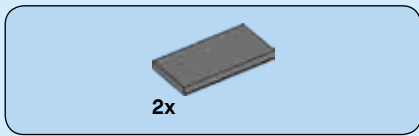

# 84

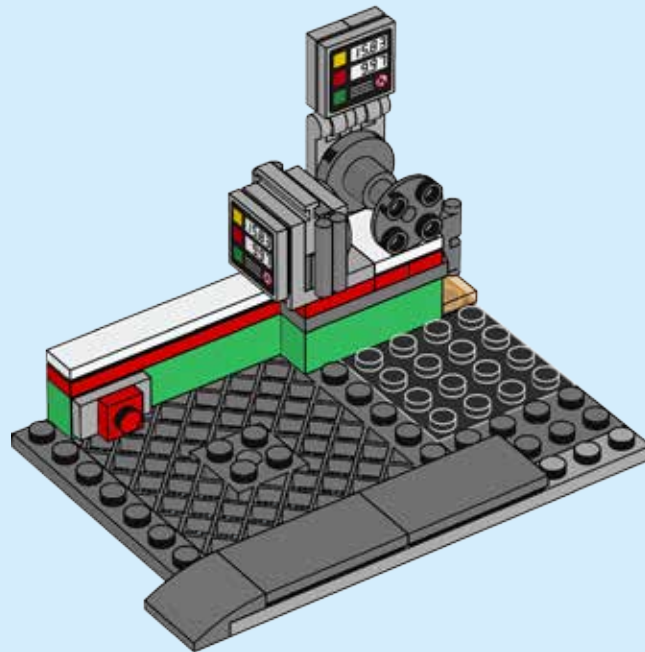

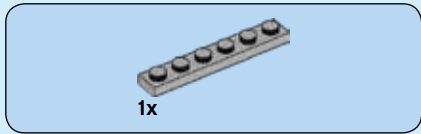

85

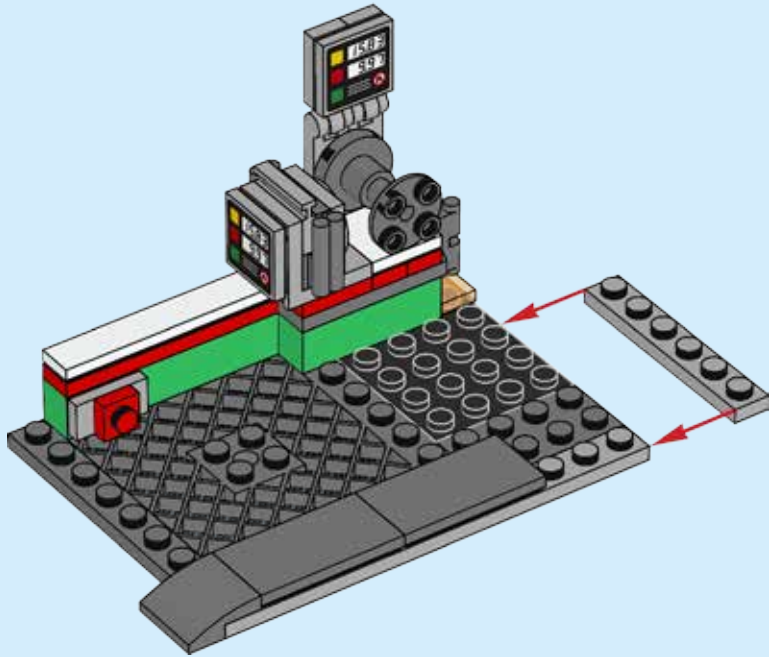

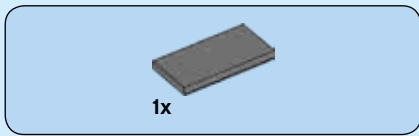

86

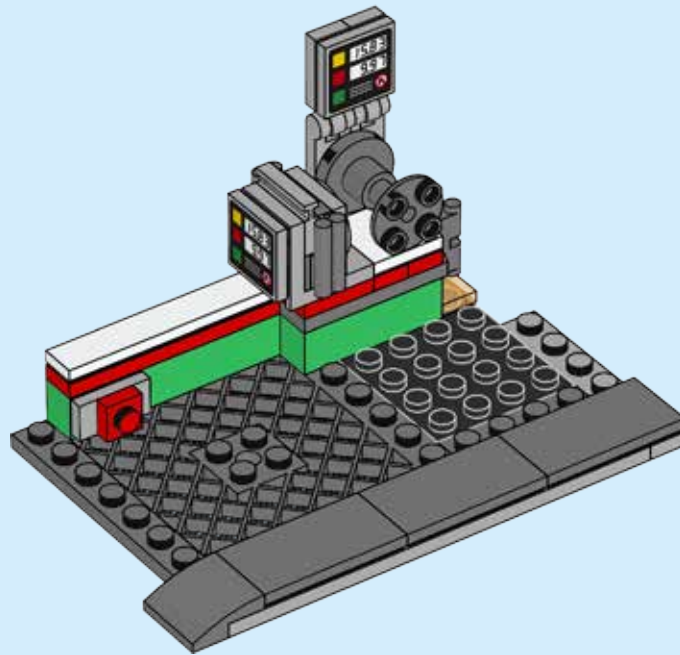

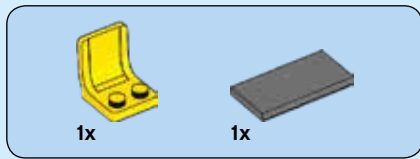

87

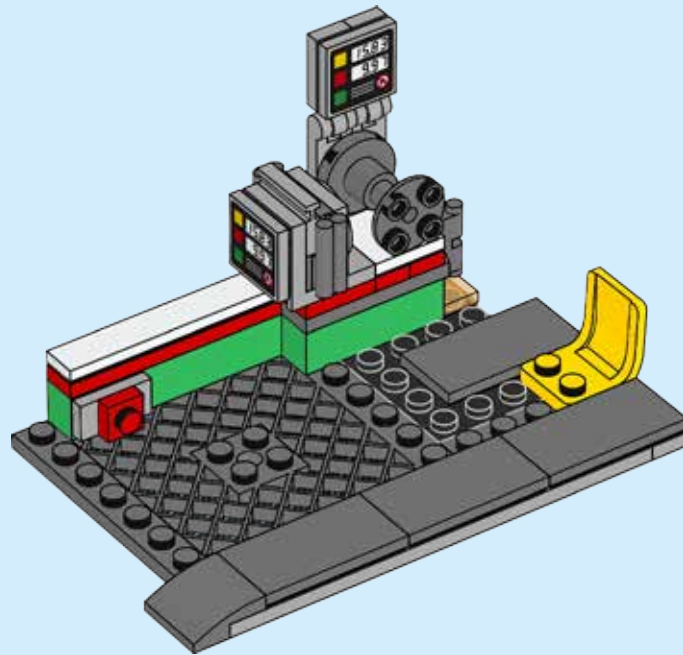



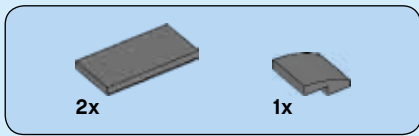

88

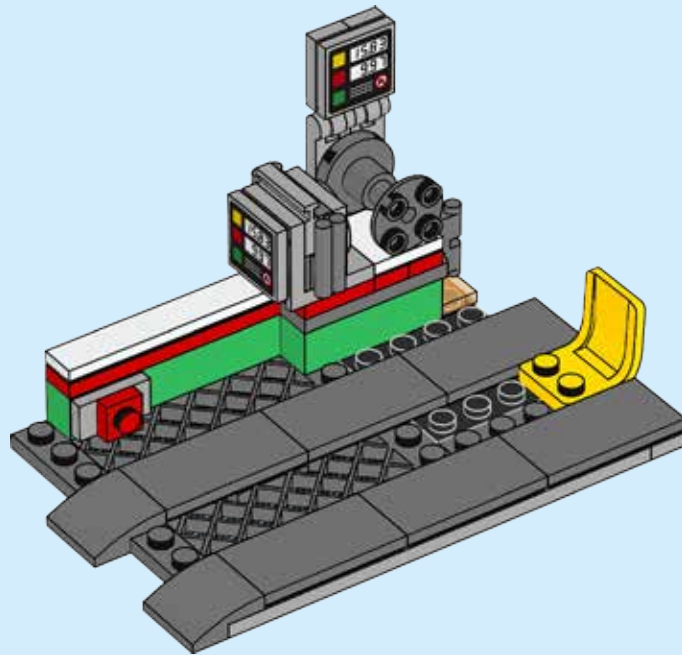

89

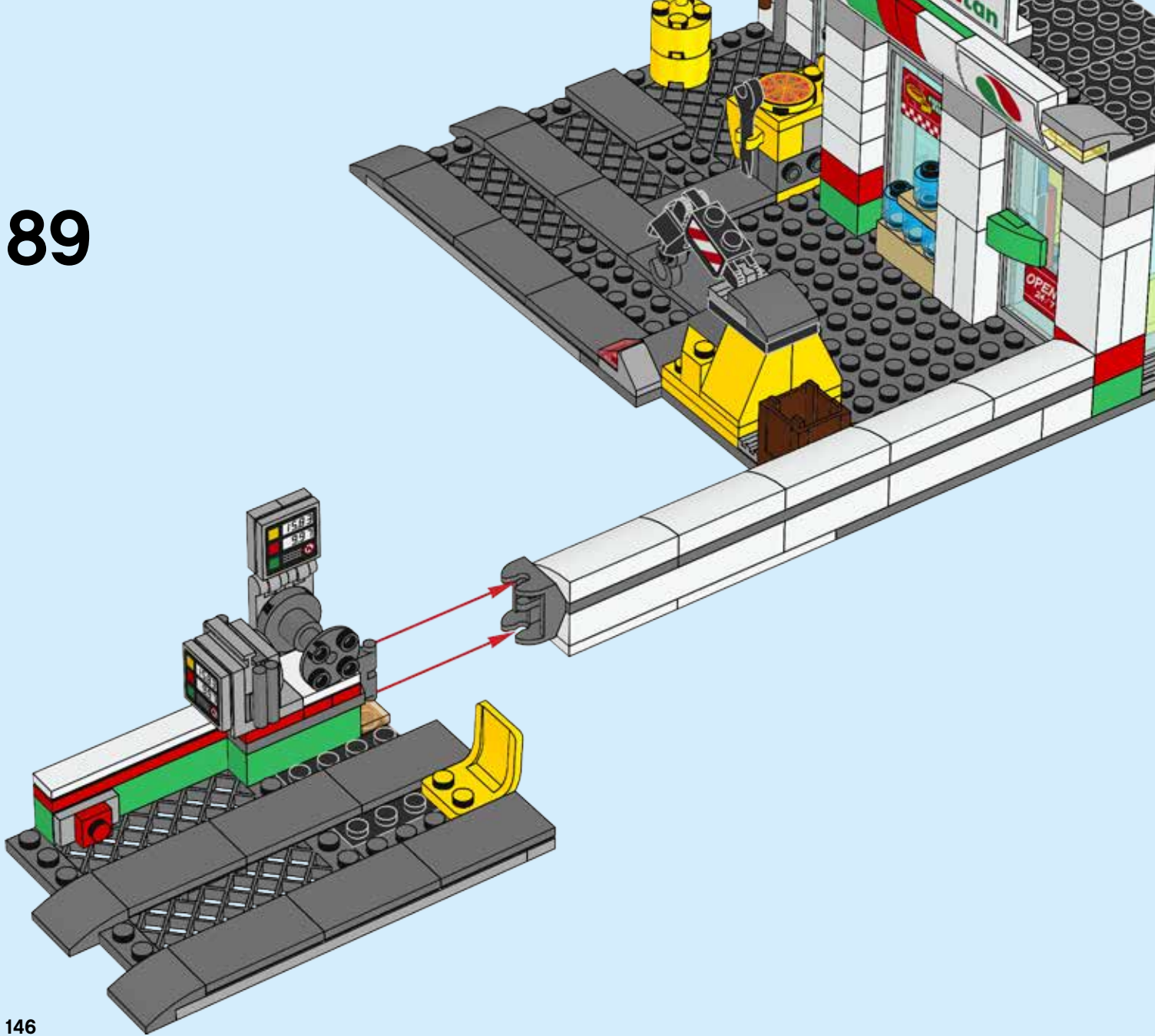



# LEGO CITY



60130



60129



60128



60127



60126