

nickelodeon

LEGO

NINJA TURTLES



79117



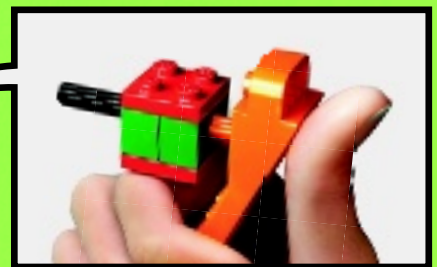
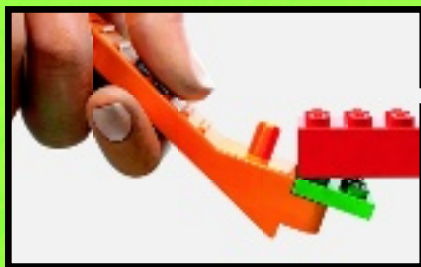

LEGO.com/brickseparator

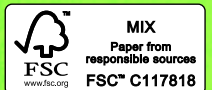

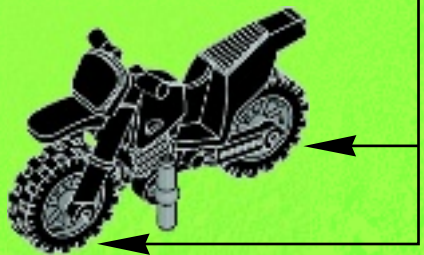
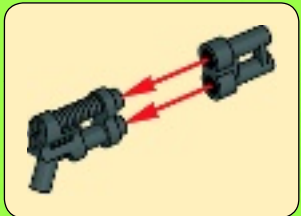
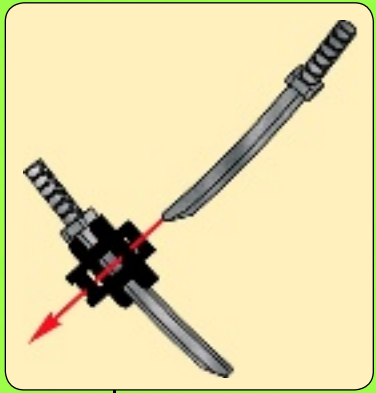
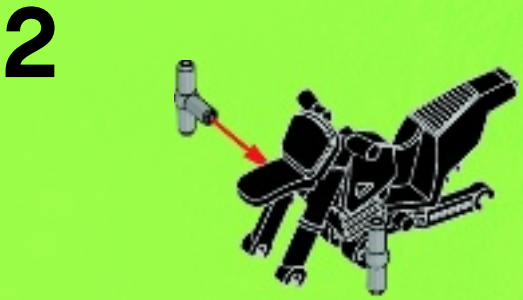
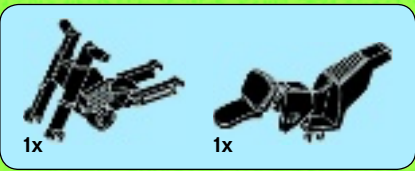
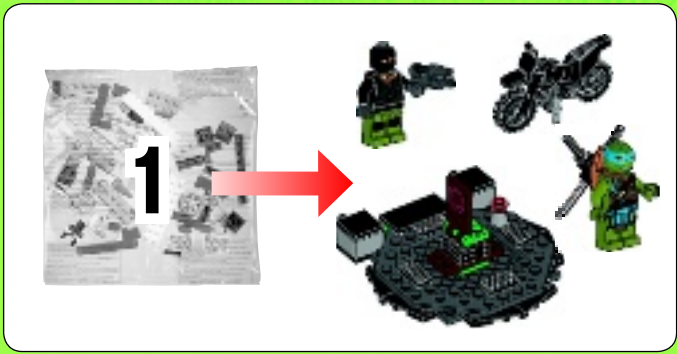

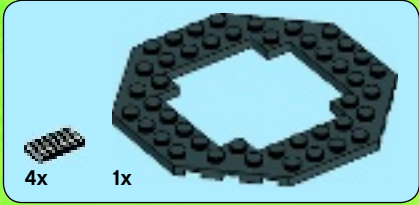

1



2



3



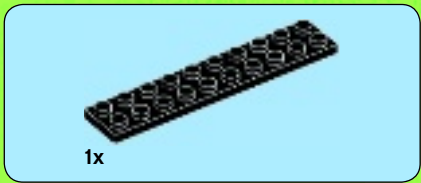

4

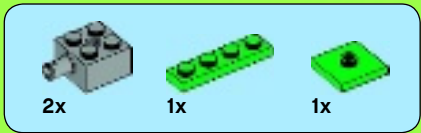

5

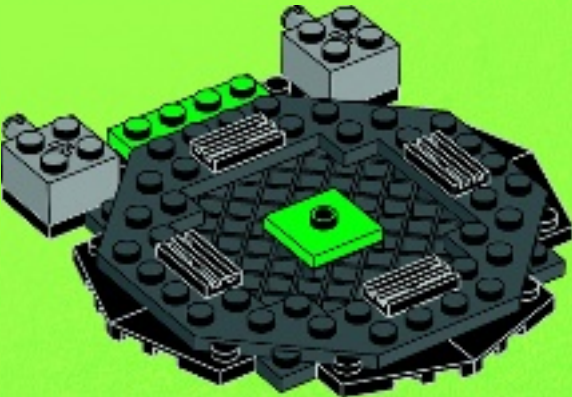

6

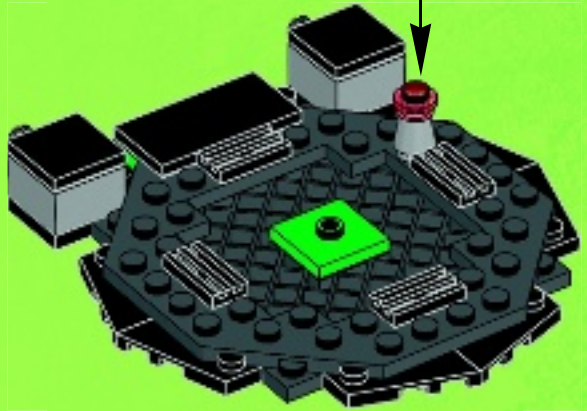

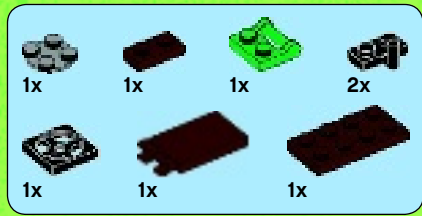

7

1



2



3



4

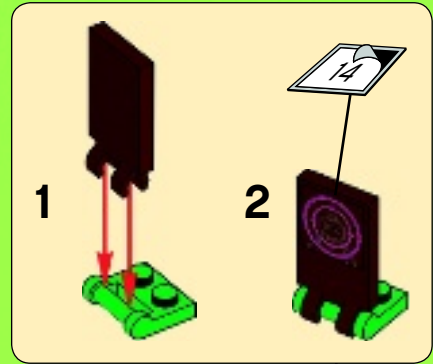

5

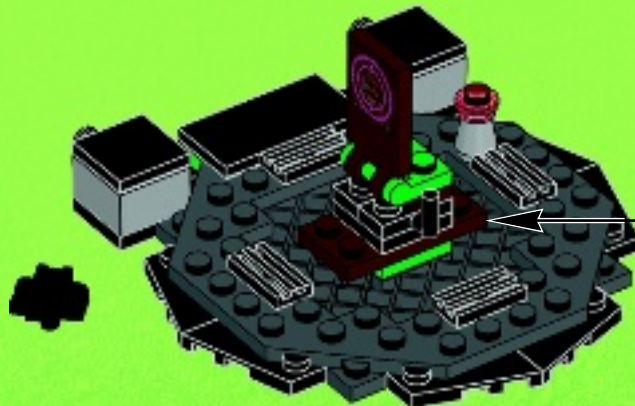

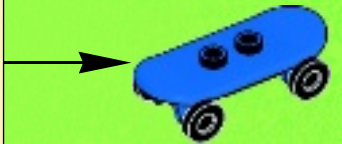
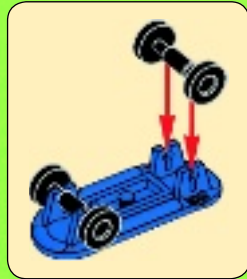
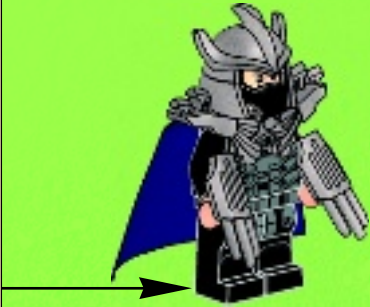
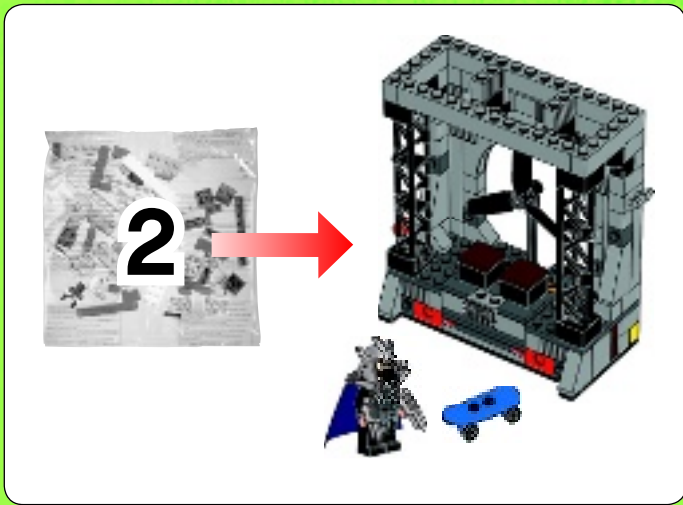

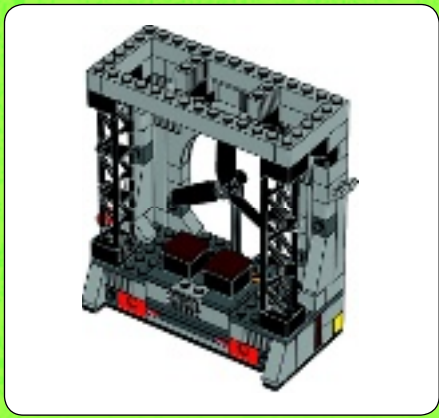

1

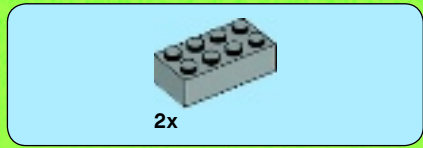

2

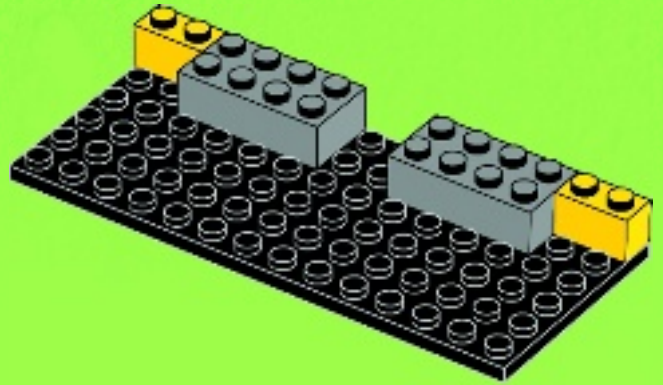

3

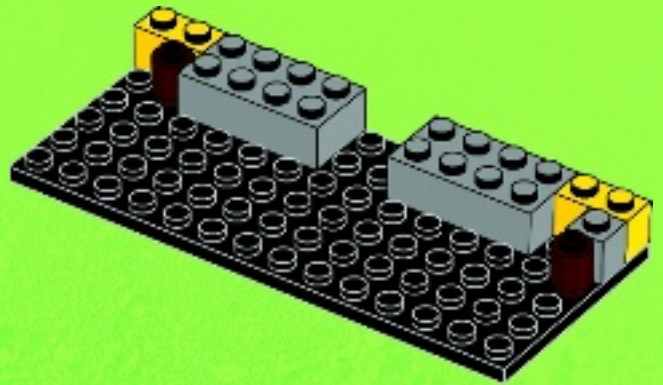

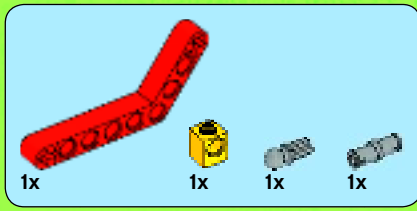

4

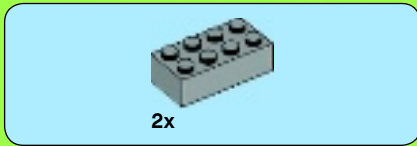
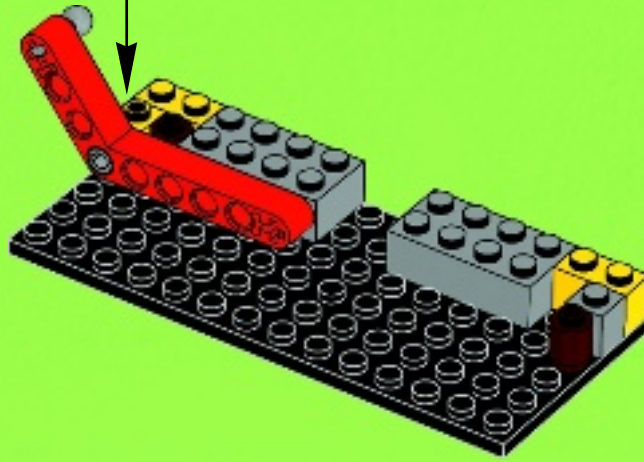
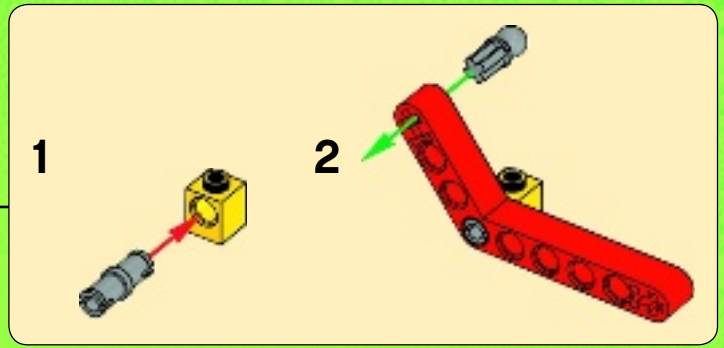

5

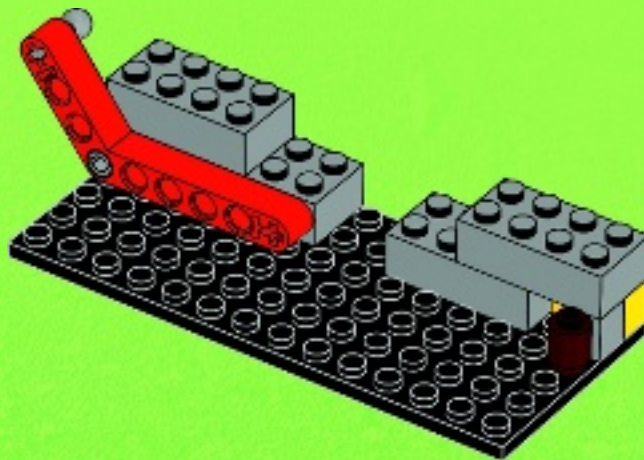



2x



1x

6

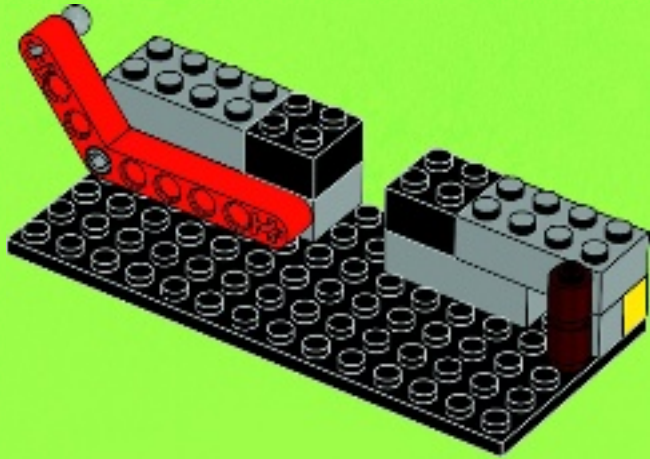

2x

7

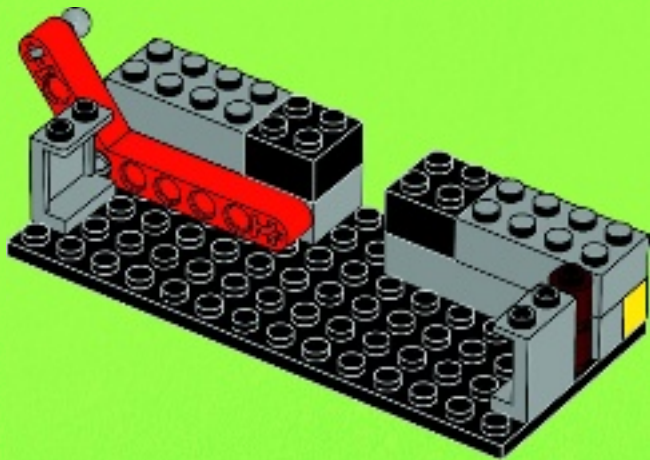

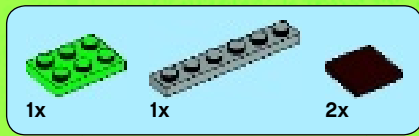

8

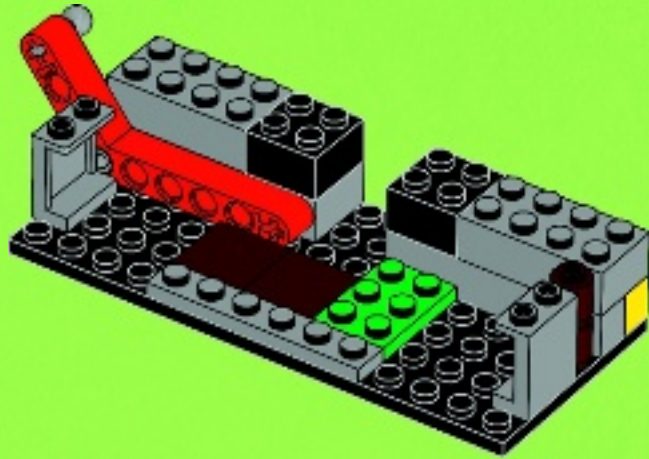

9

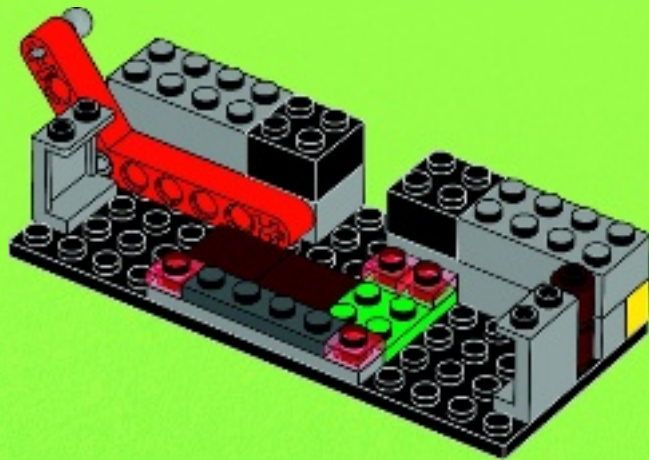



10

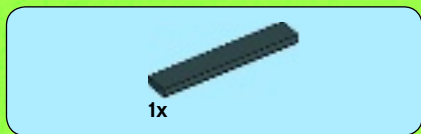
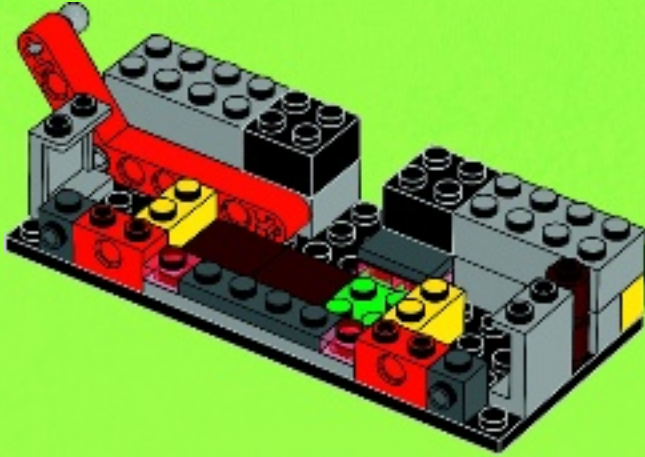

11

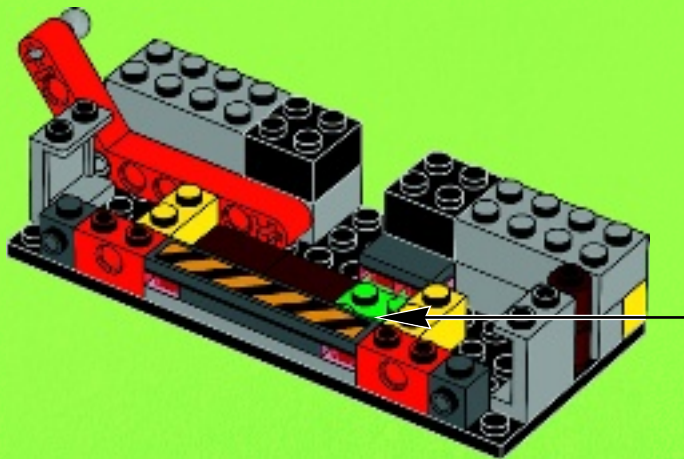



2x



2x

12

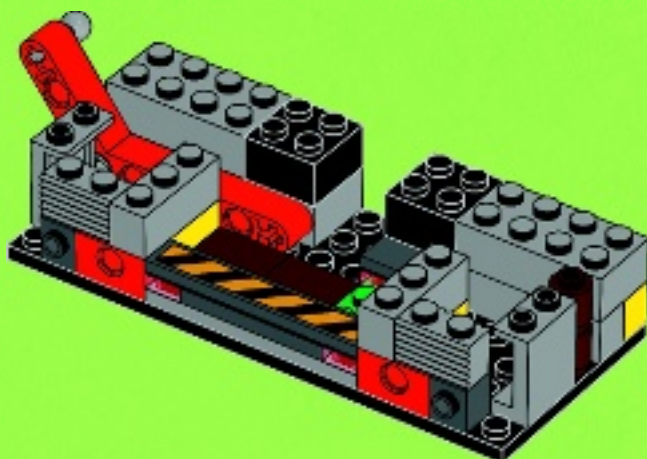

2x



2x

13

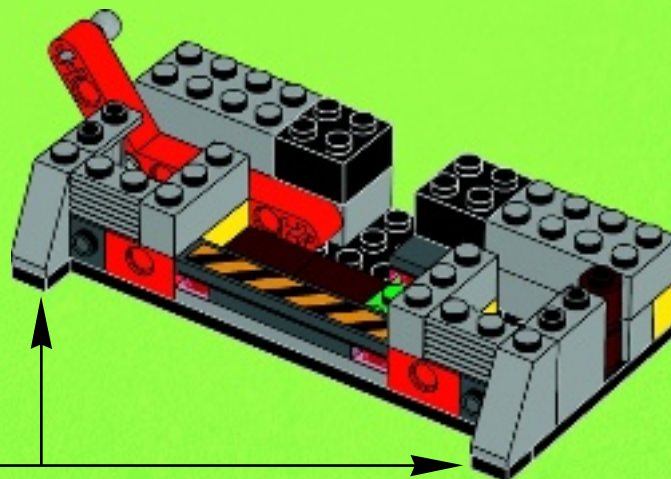

1



2



1:1

2x



14

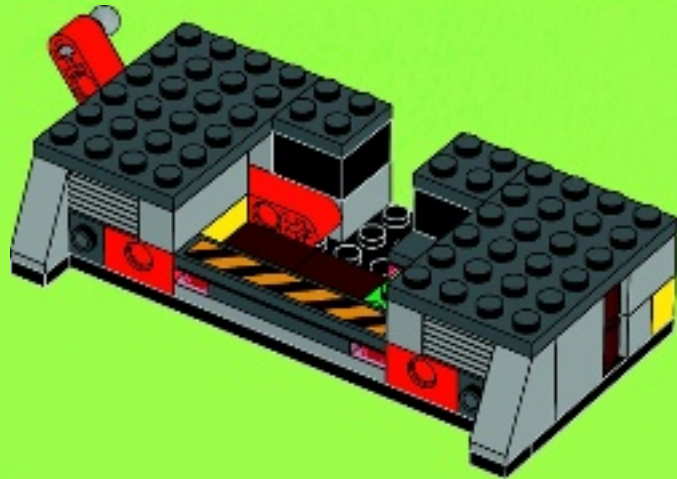

15

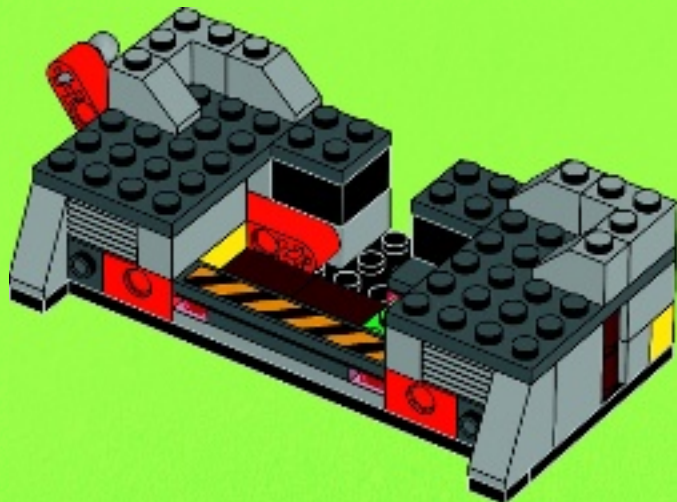

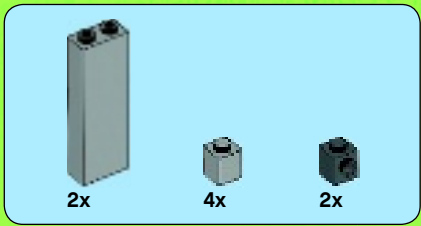

16

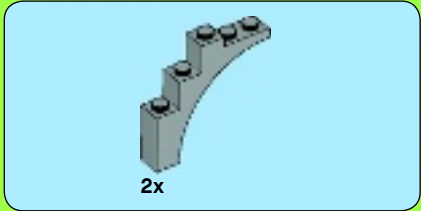
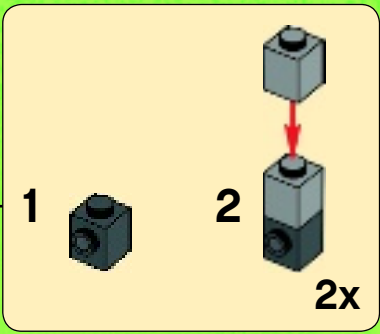
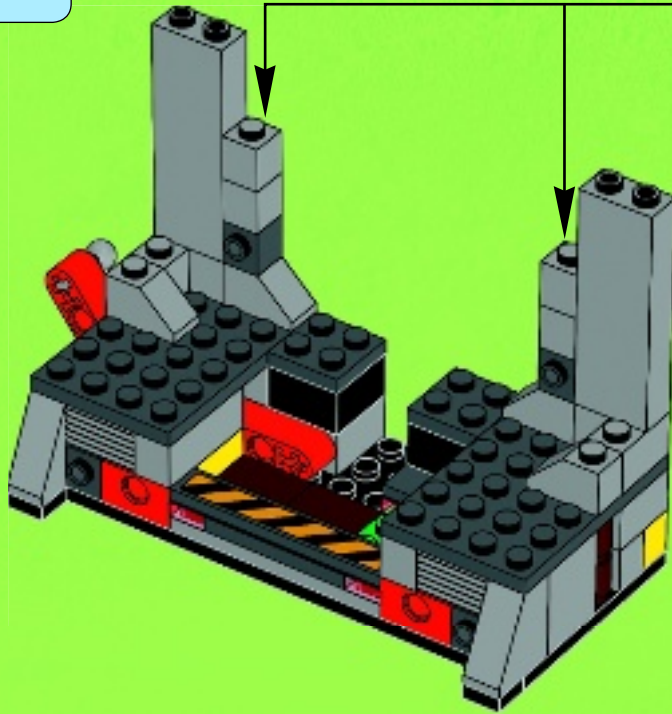

17

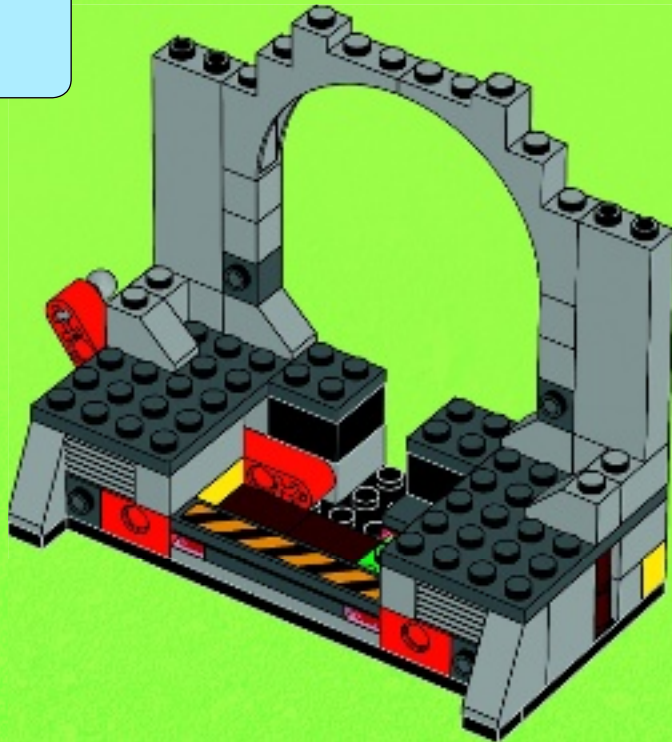

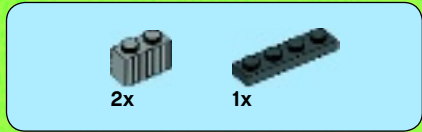

18

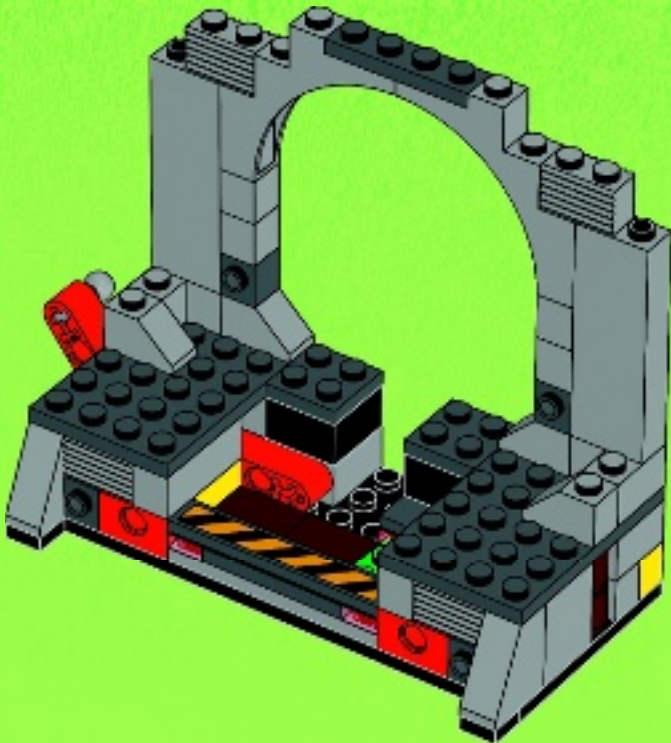

19

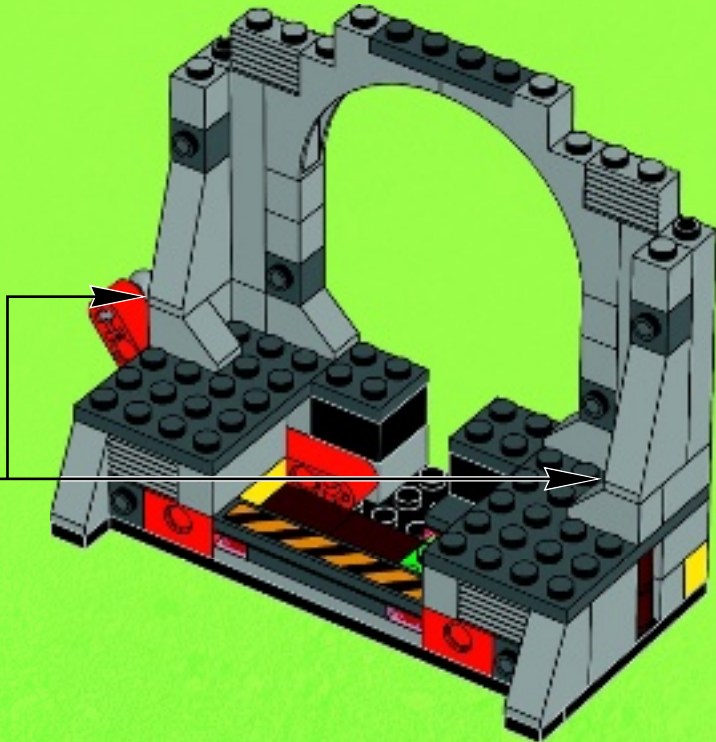
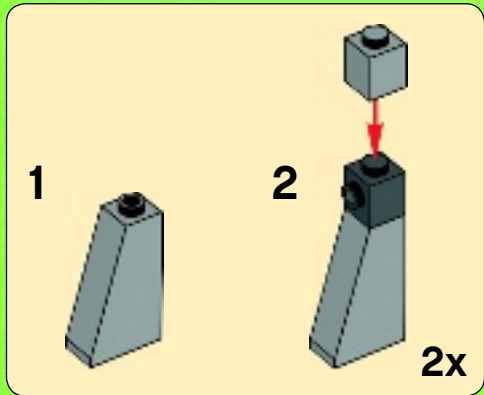



2x

20

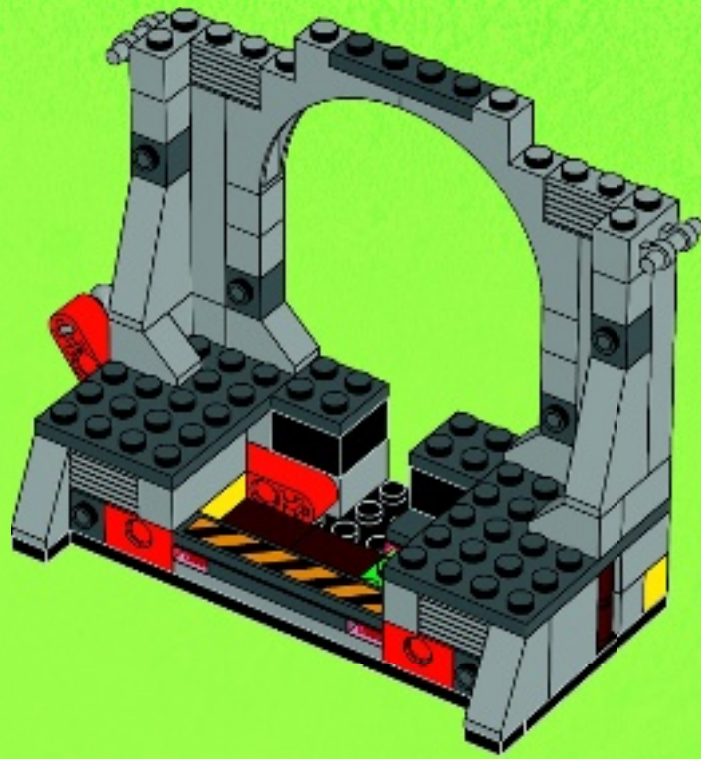

2x



2x

21

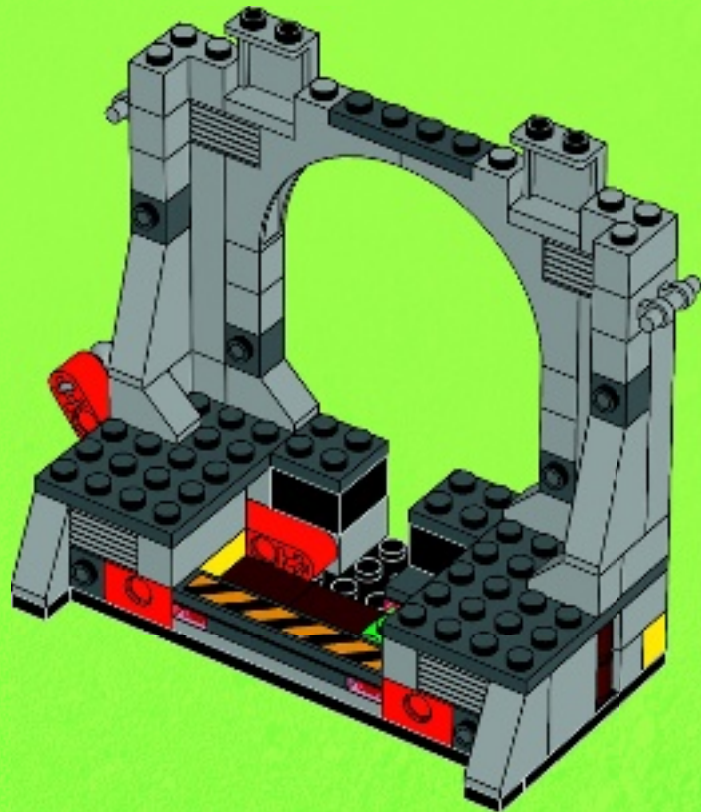



2x



2x

22

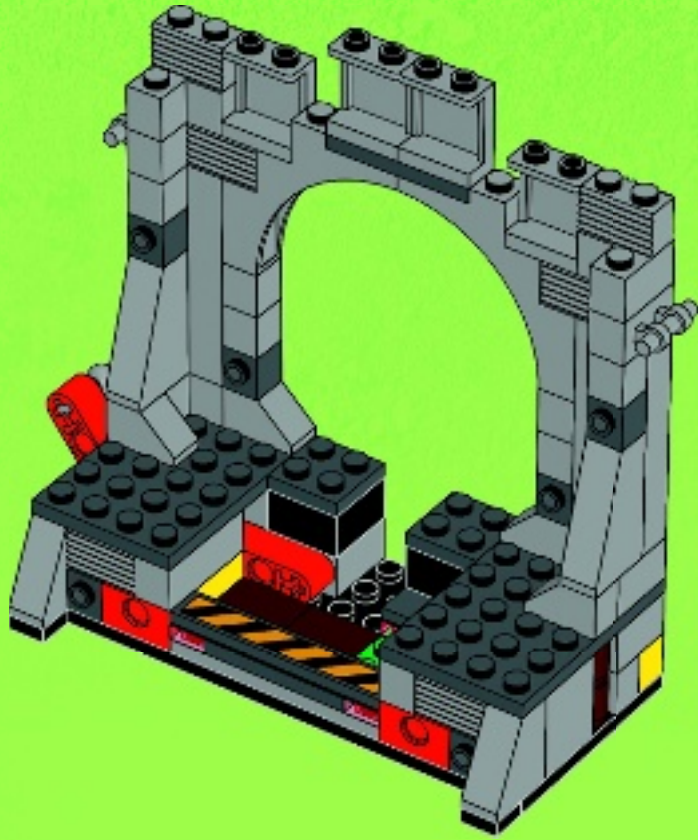

4x

23

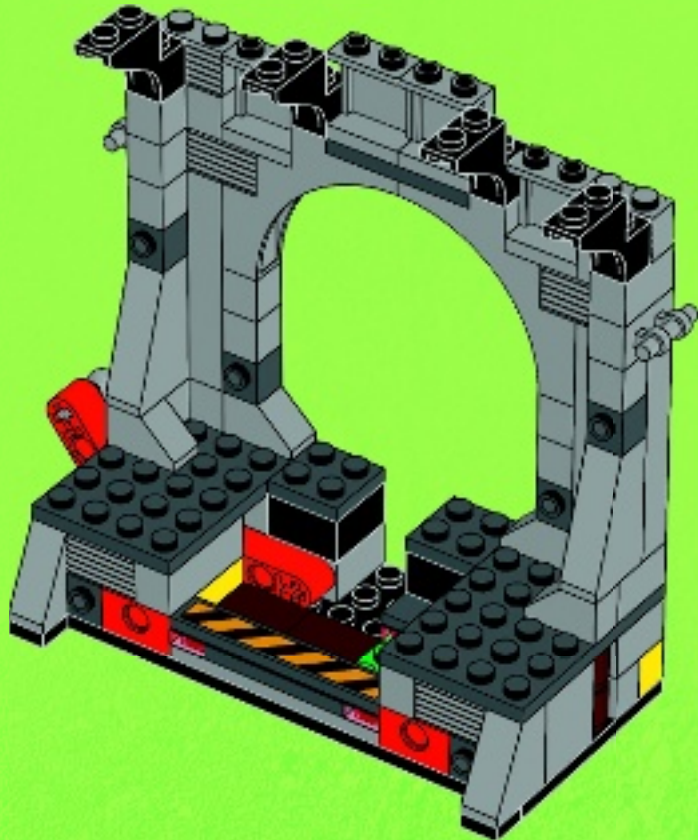



2x



2x

24

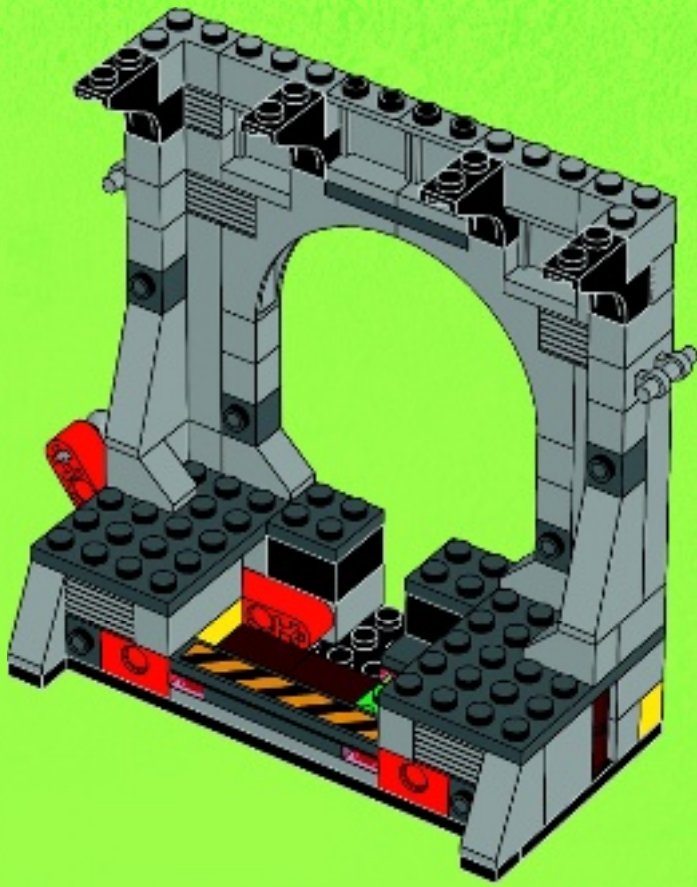

2x

25

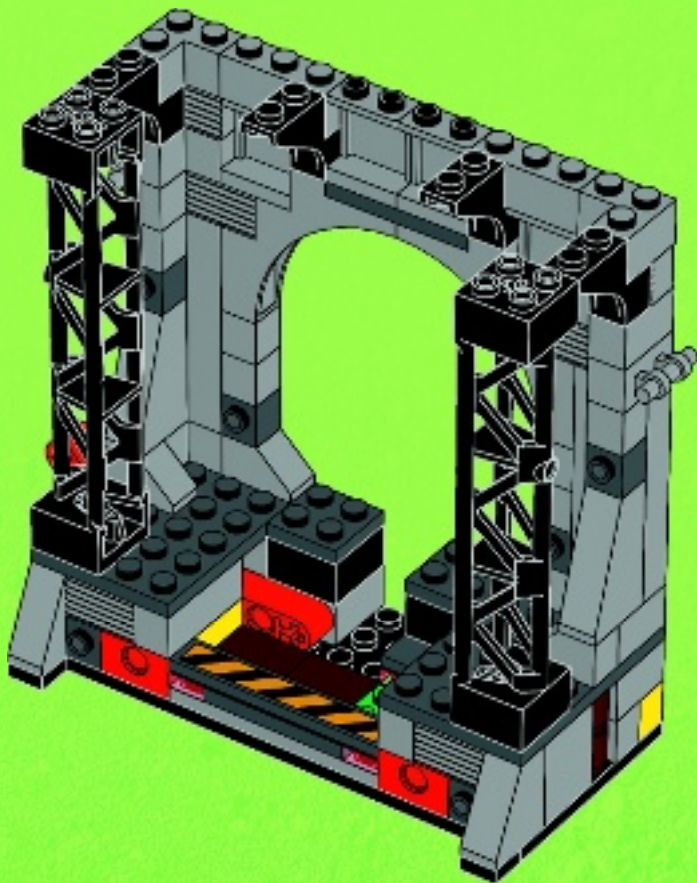

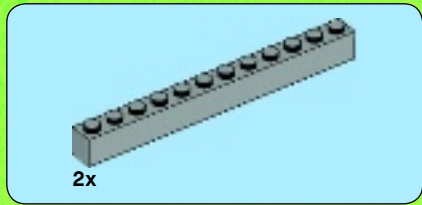

26

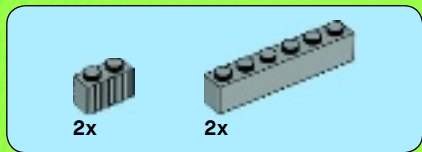
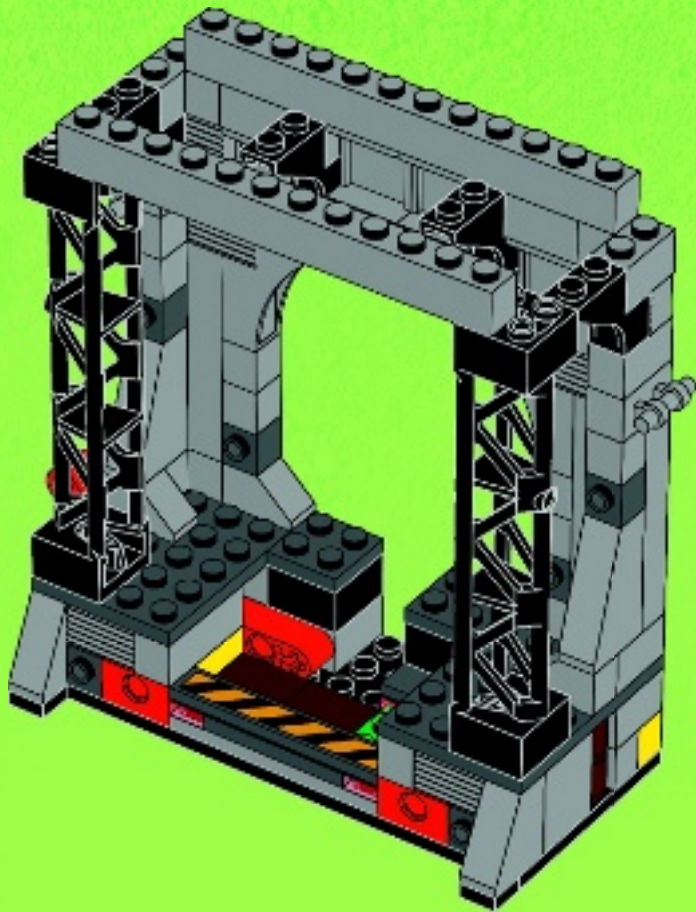

27

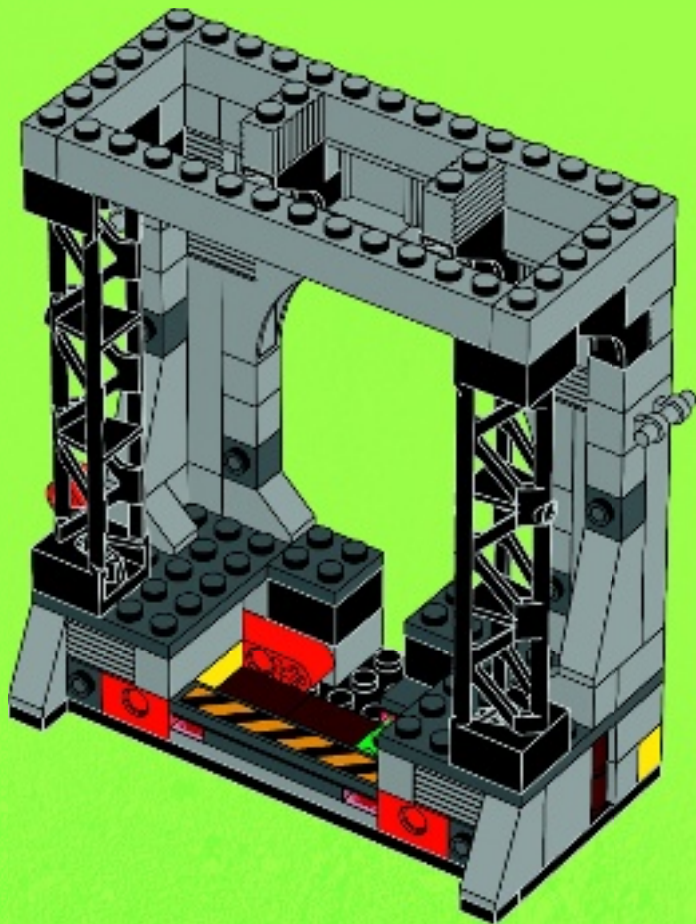

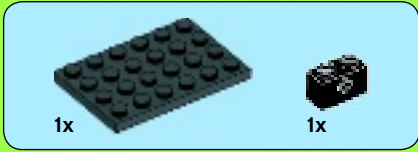

1

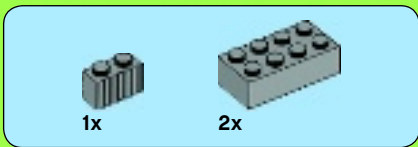

2

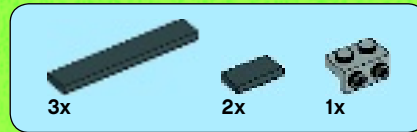

3

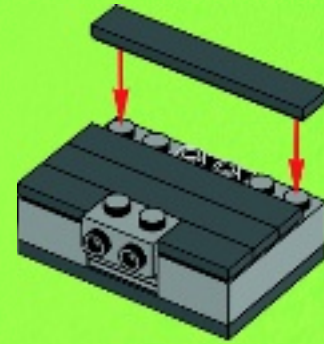

4

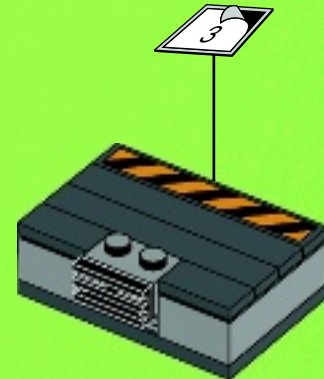

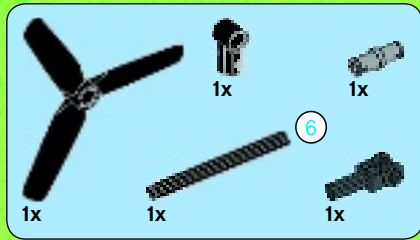

5

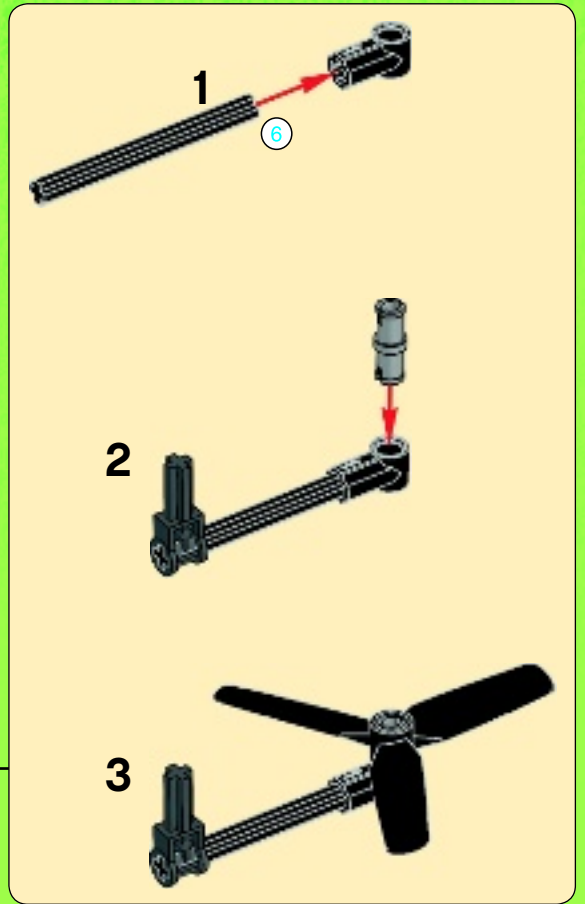
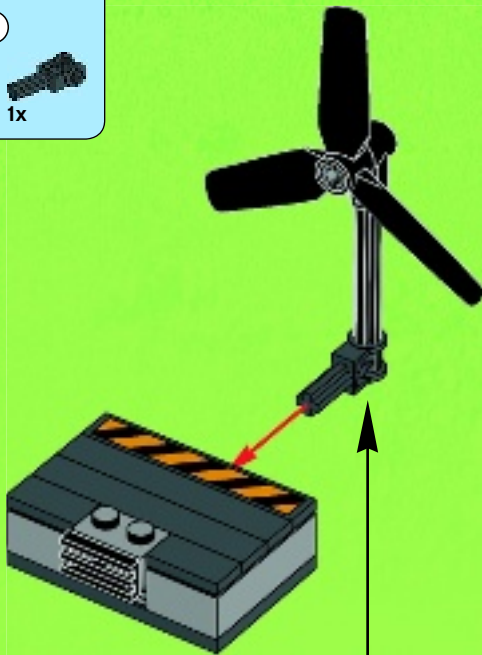

28

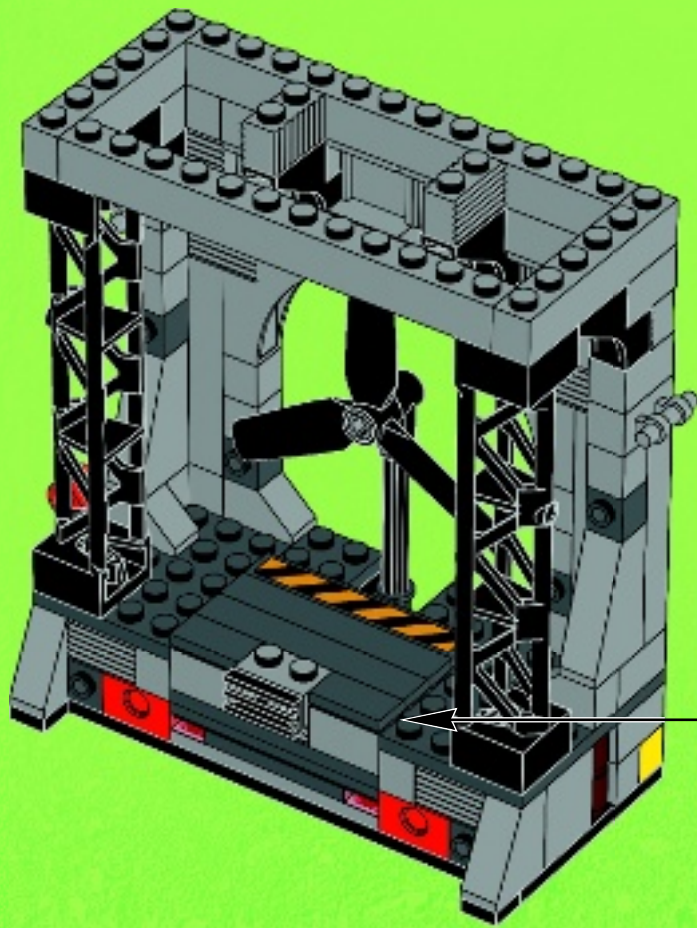



2x



2x

29

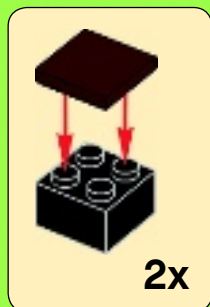
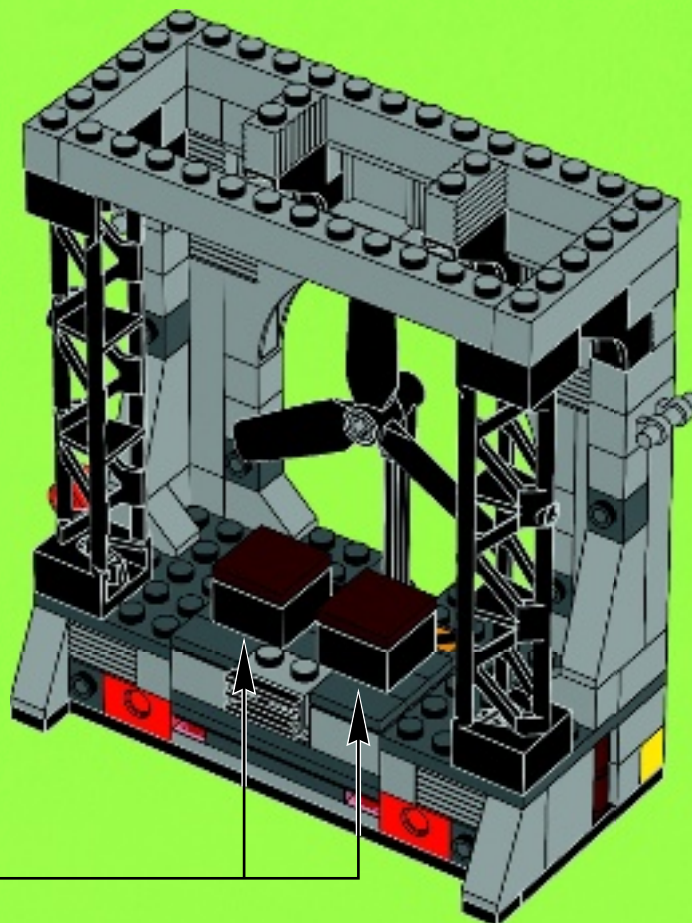

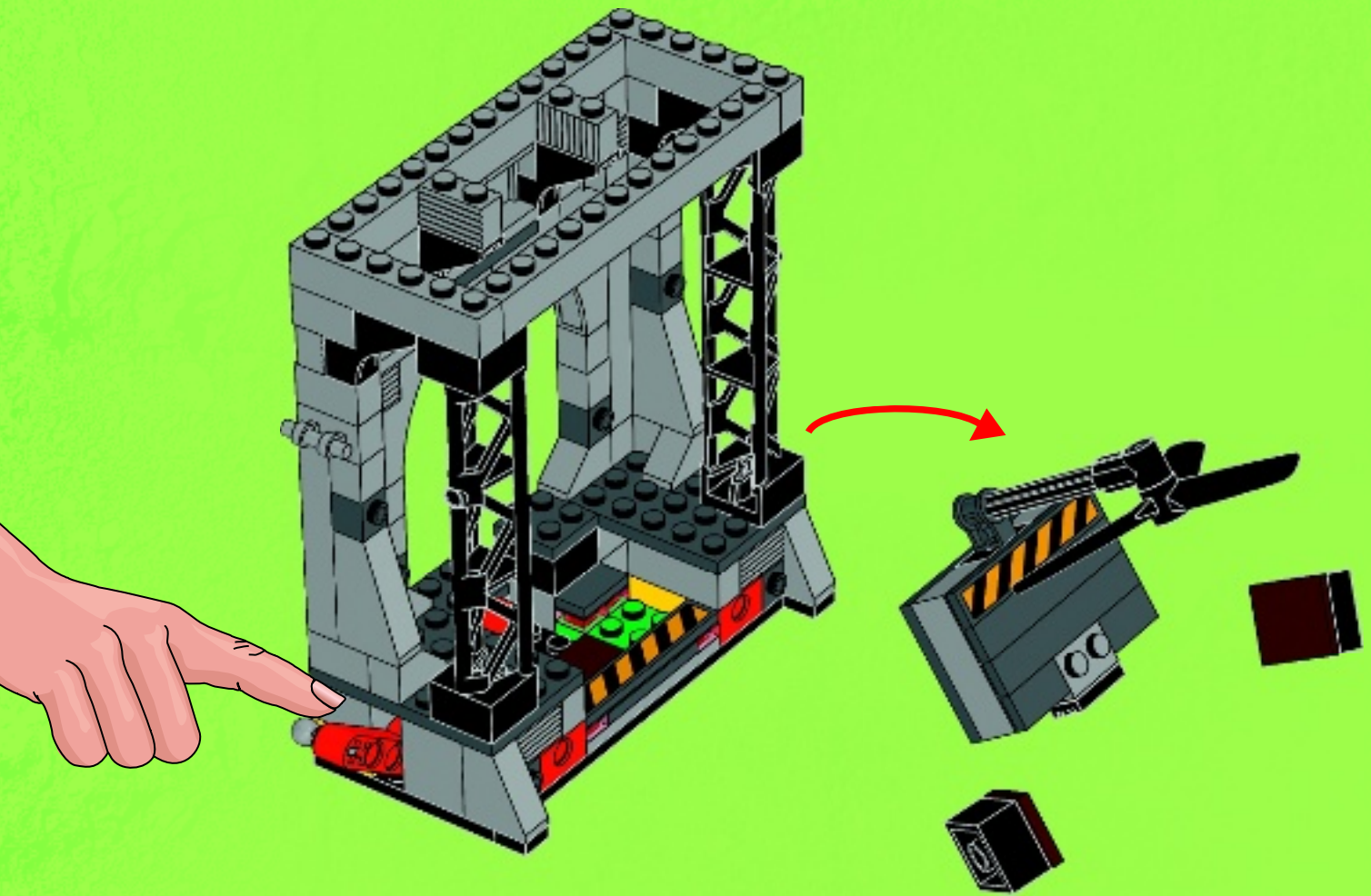



3

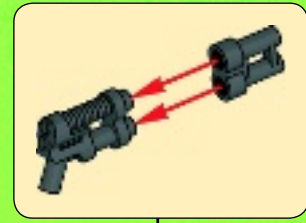
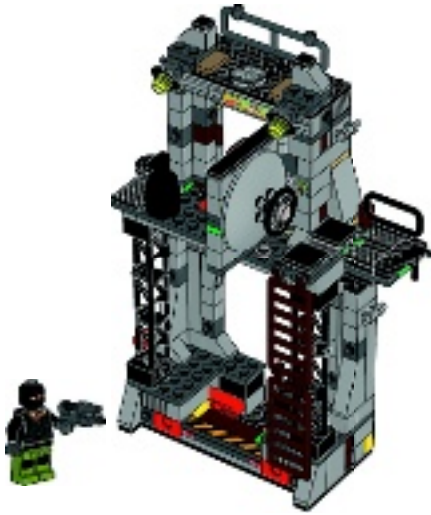

2x

2x

30

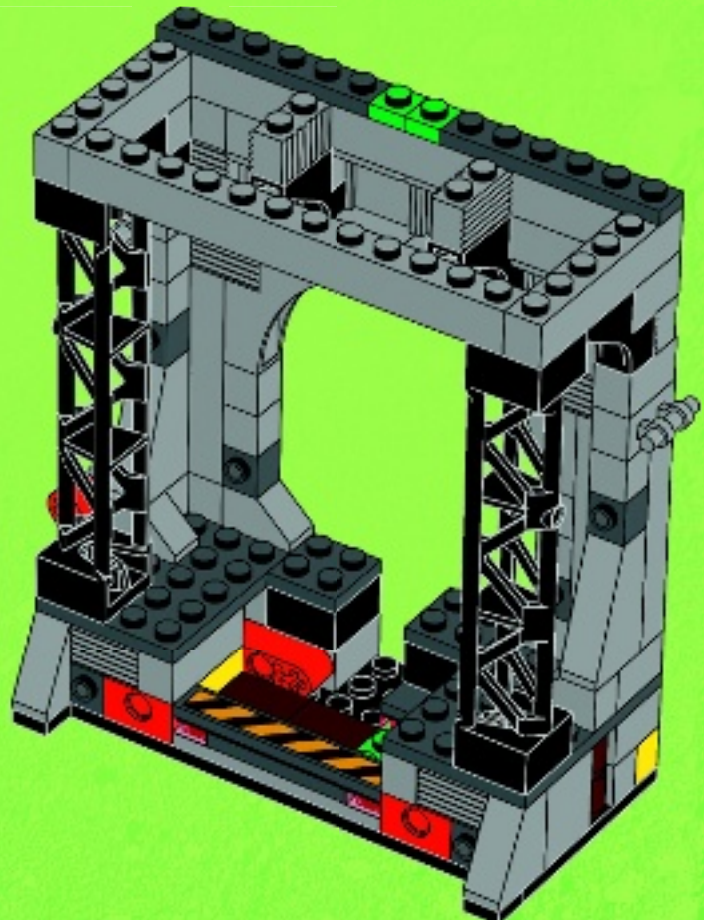

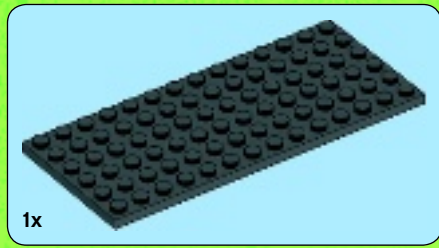

31

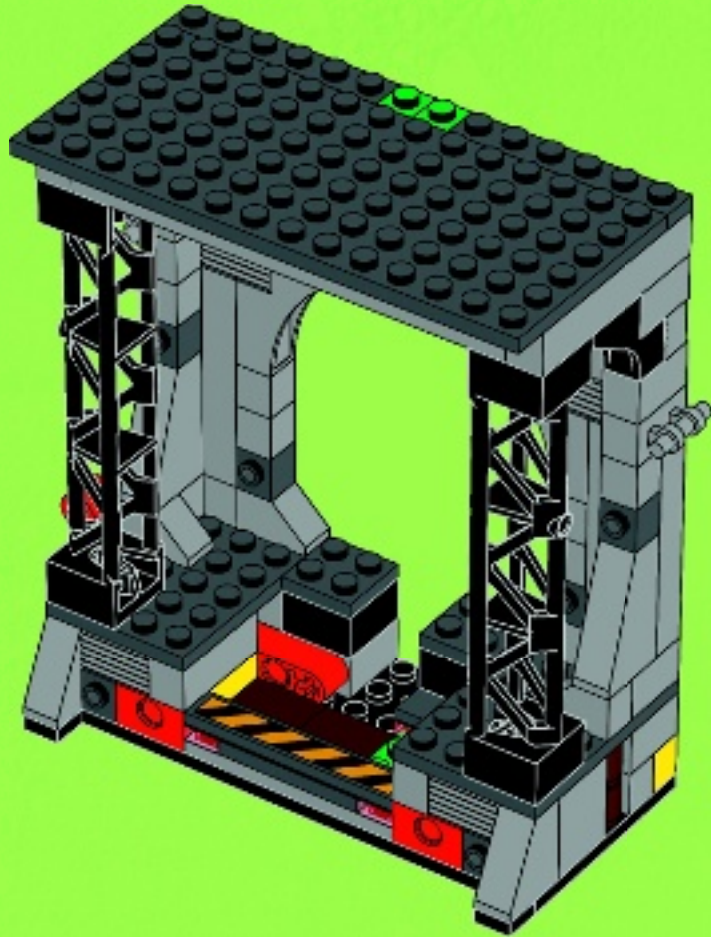



2x



2x



2x

32

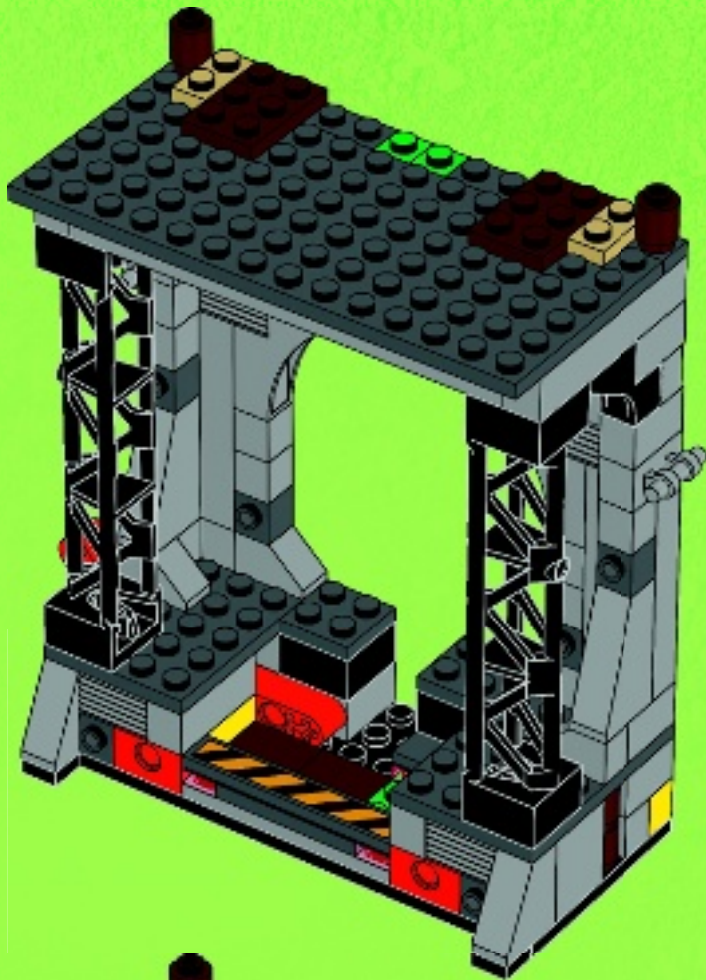

1x



2x

33

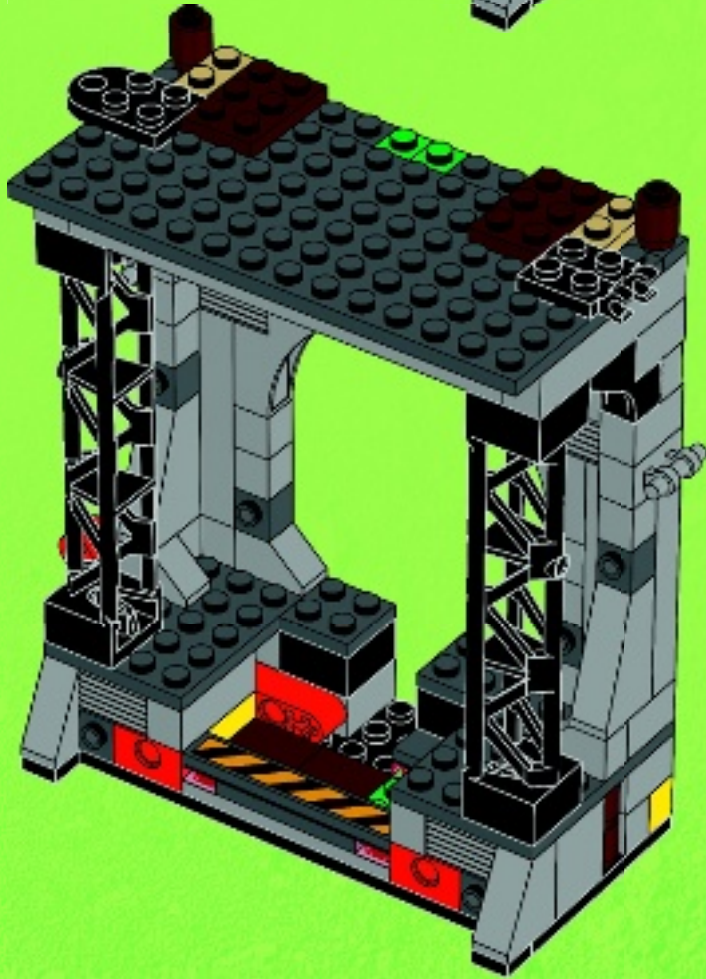



34

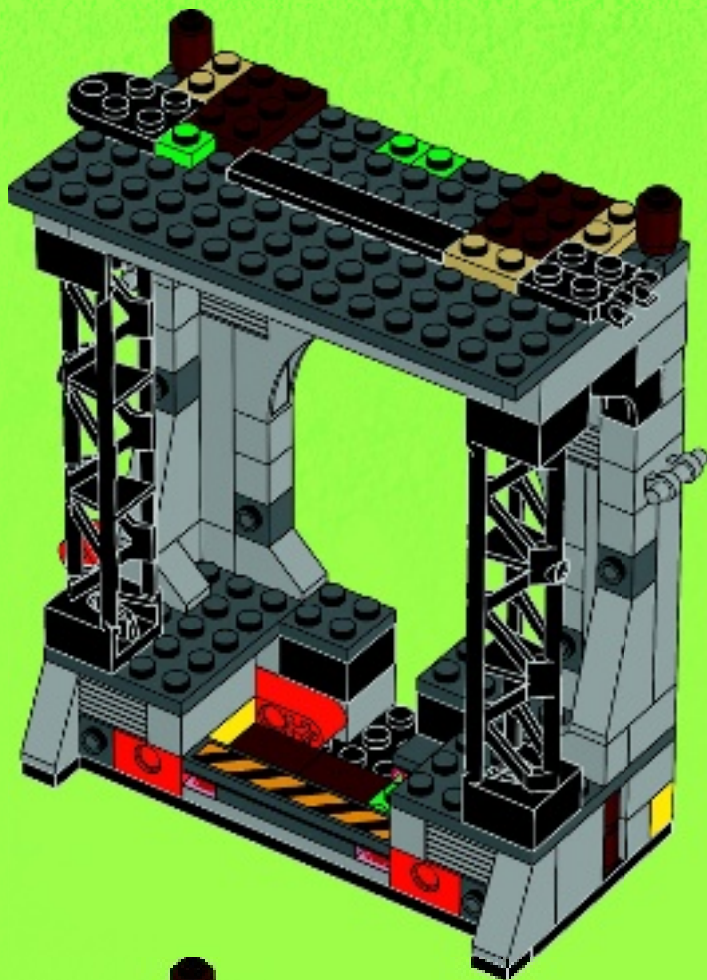

35

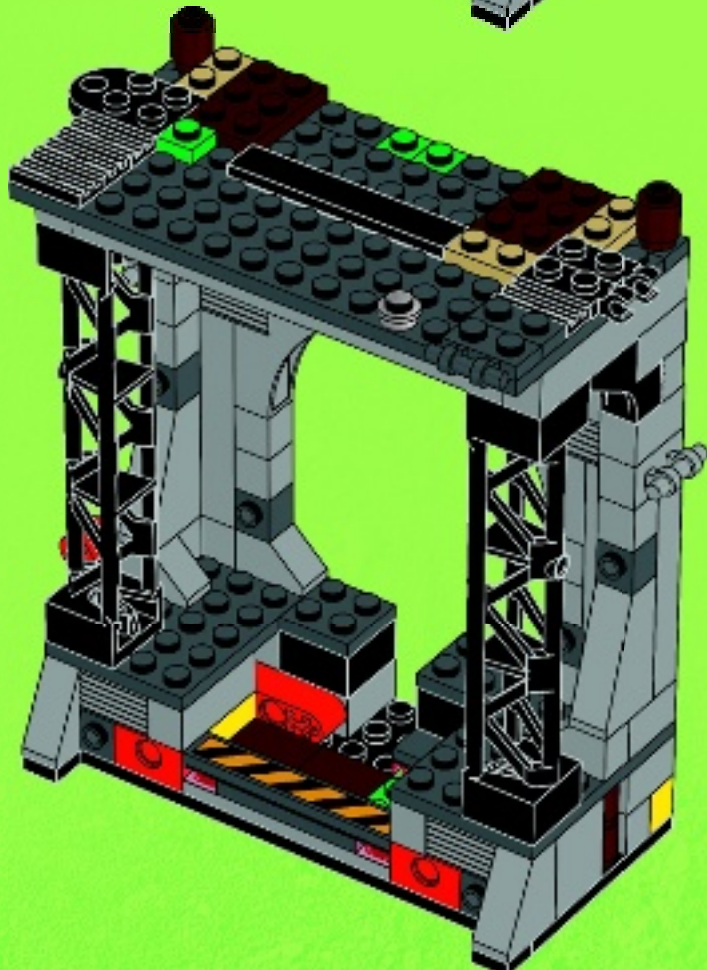

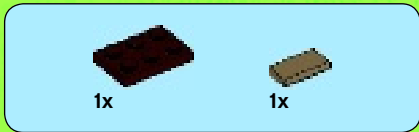

36

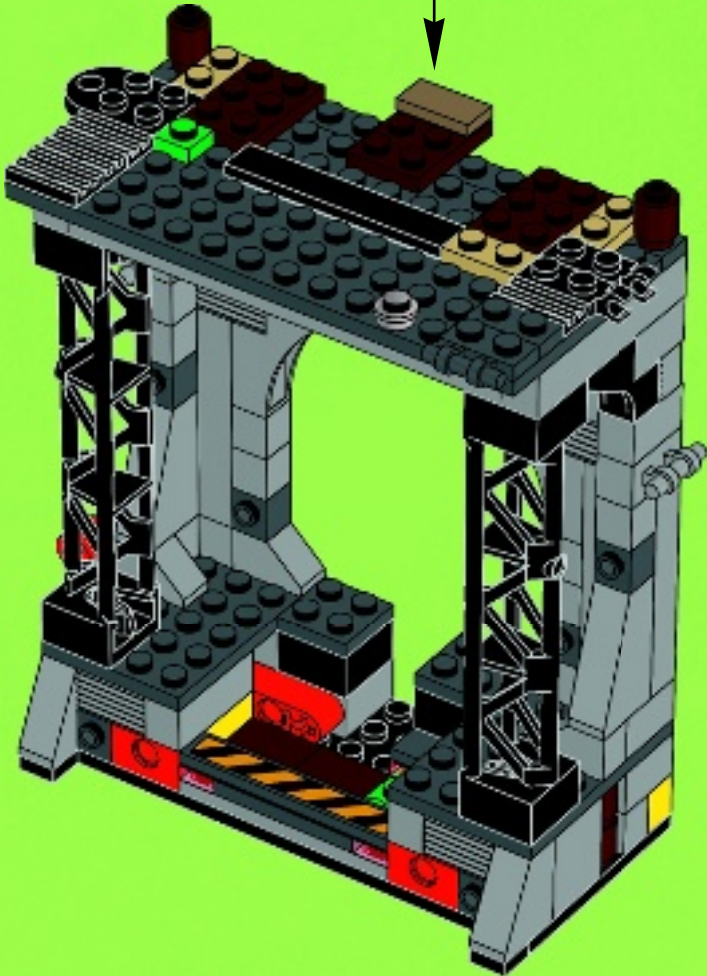



1x



1x

1

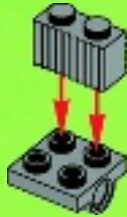

1x



1x

2

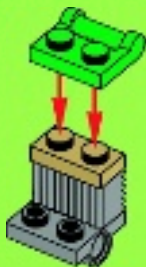

1x



2x



2x

3

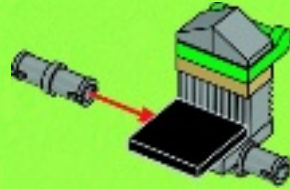

2x



2x



2x



2x



2x

4

1  2  3 

2x

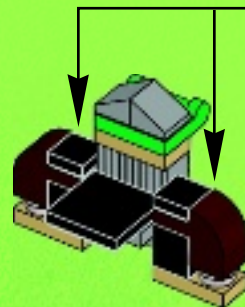

37

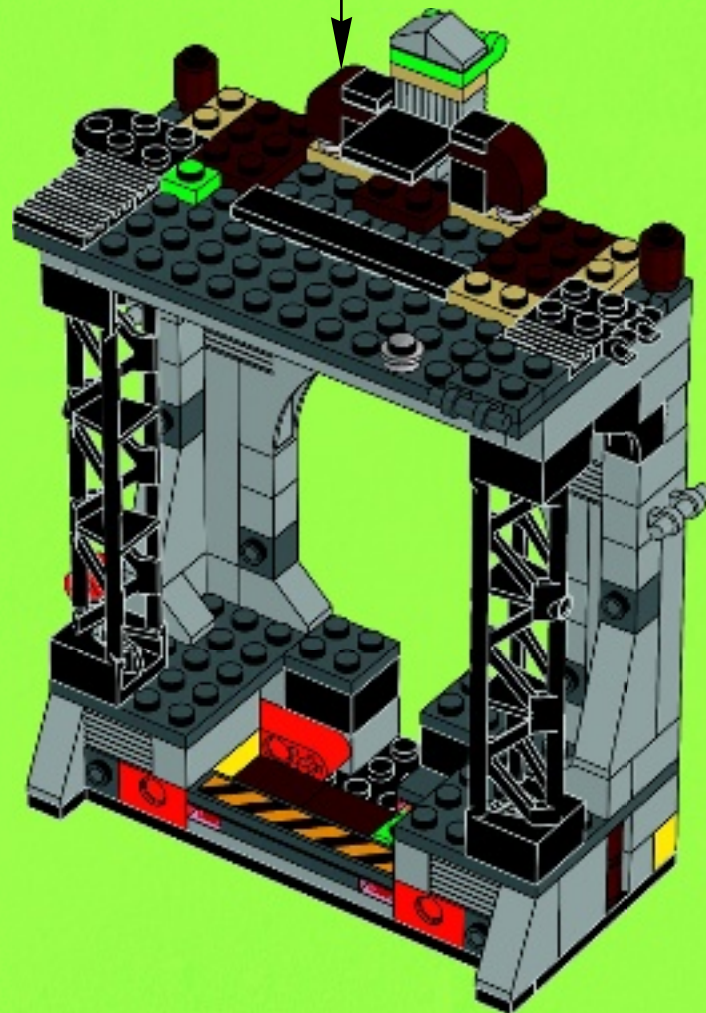



2x

38

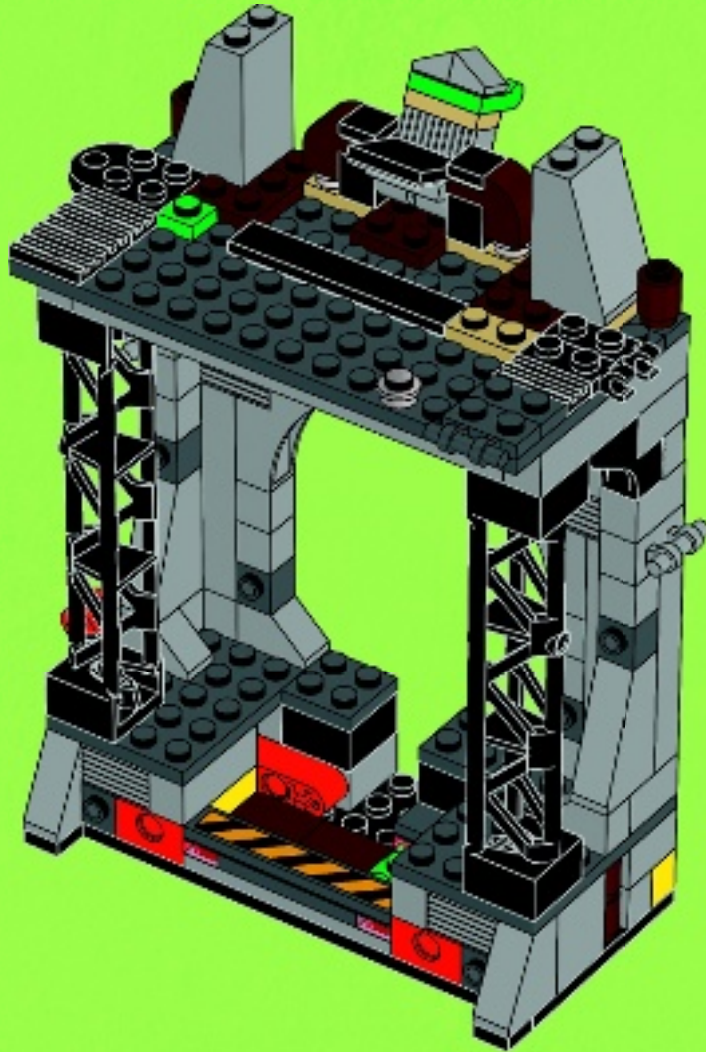



39

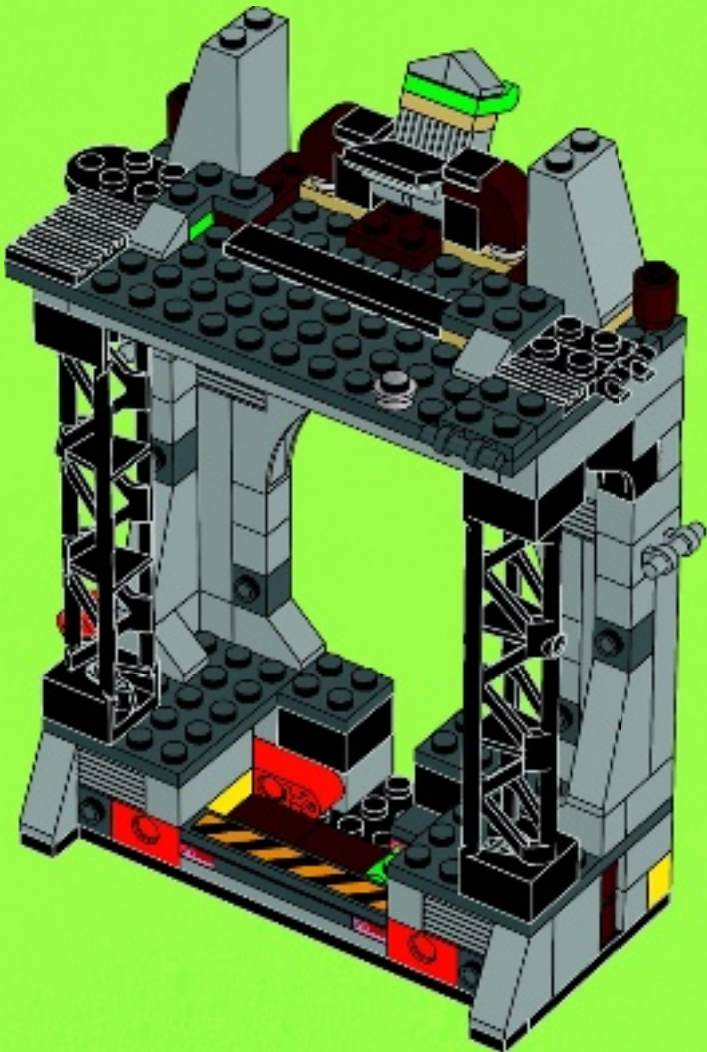



3x



2x

40

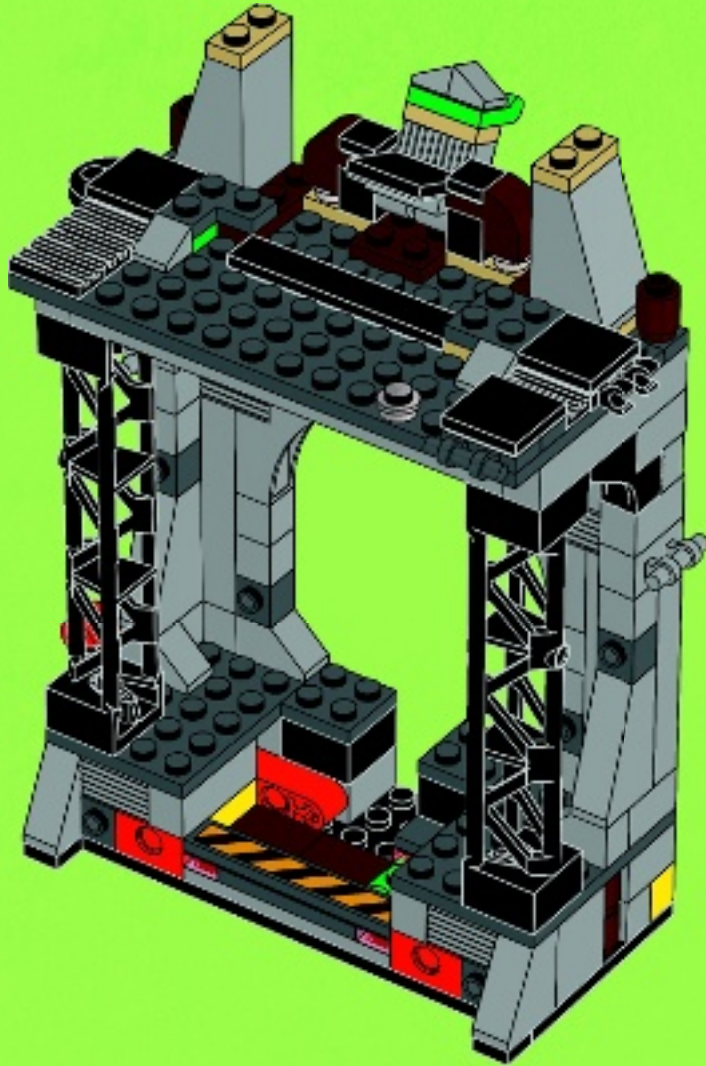



1x



2x

41

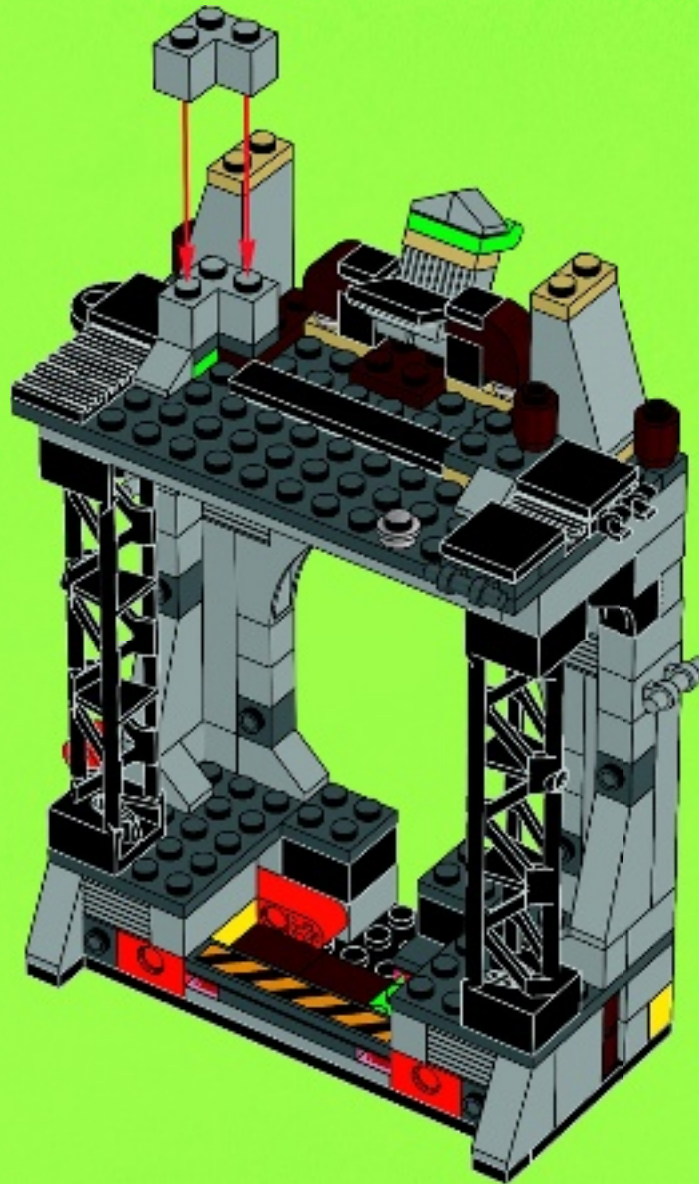



2x



1x

42

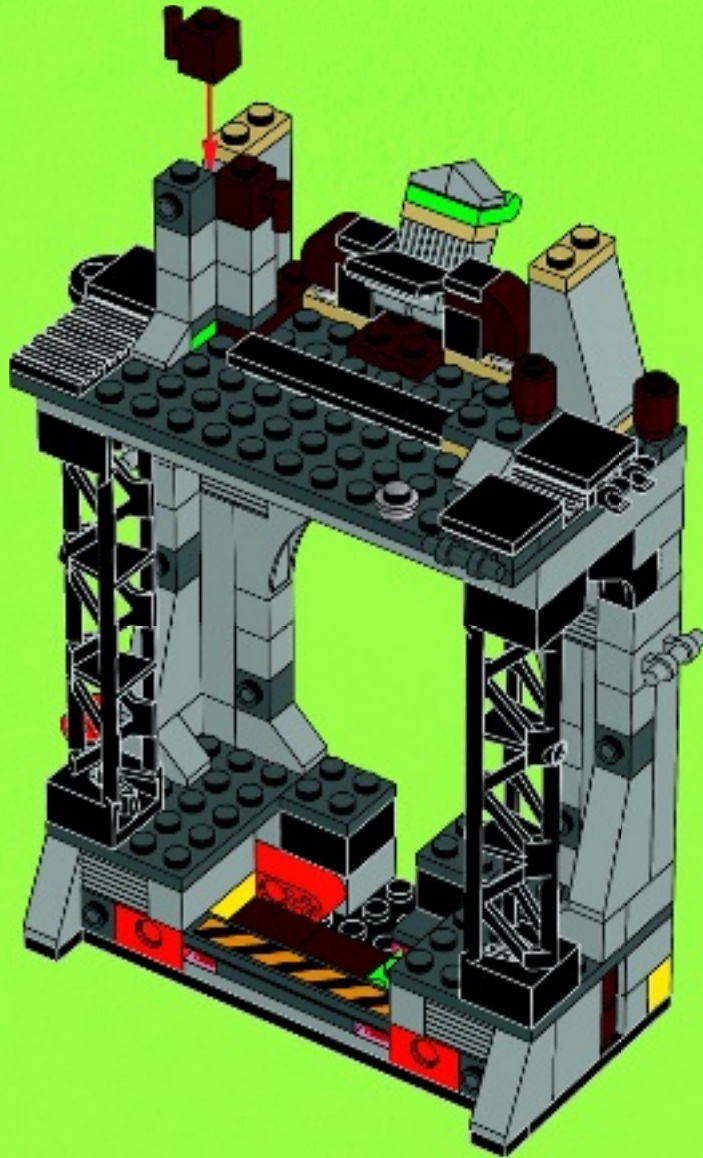



1x



1x

43

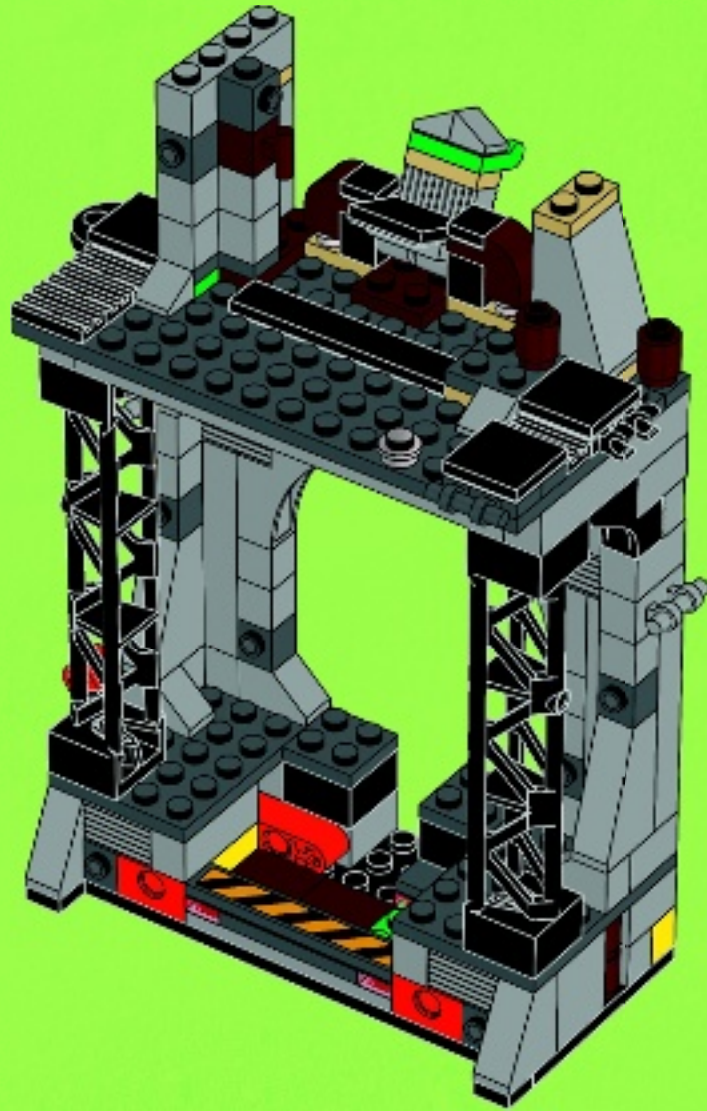



1x



1x

44

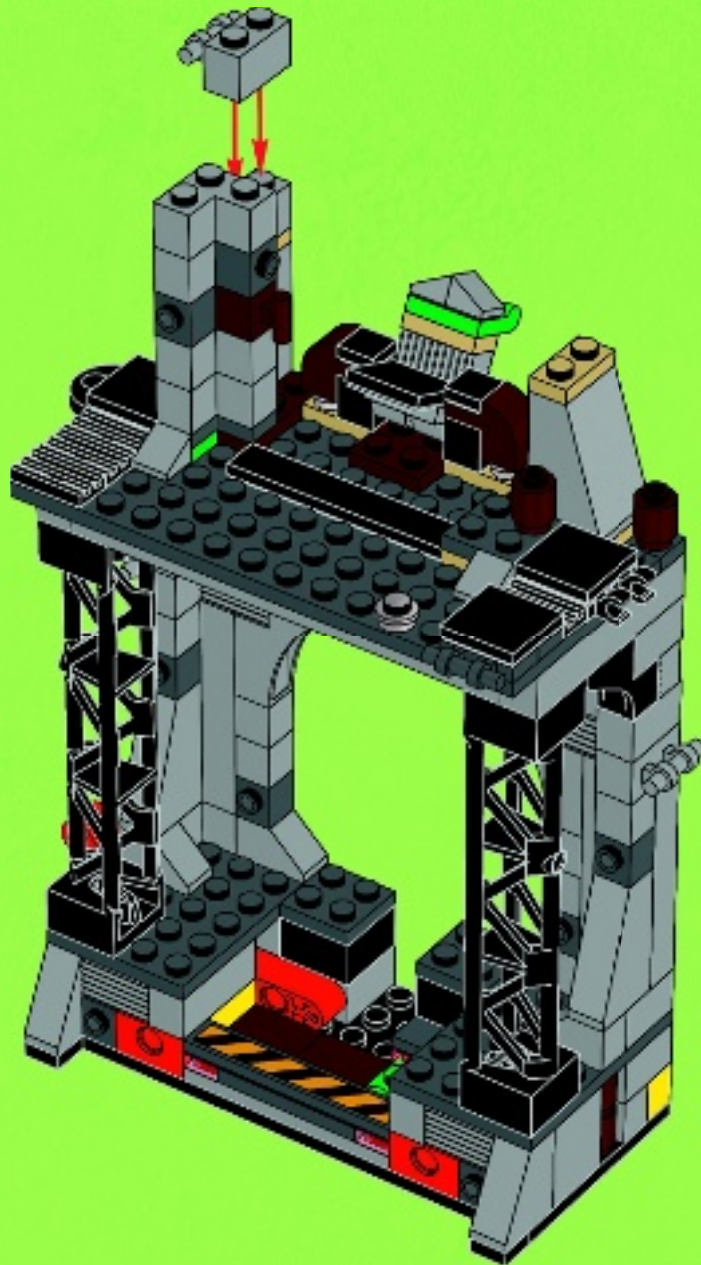



1x

1



1x



1x



1x

2

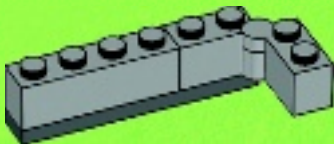
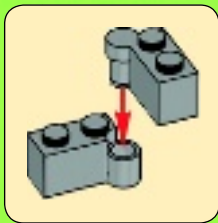

1x

3

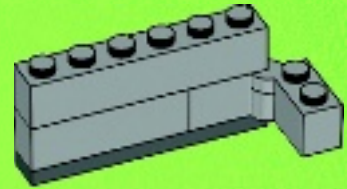

1x



1x

4

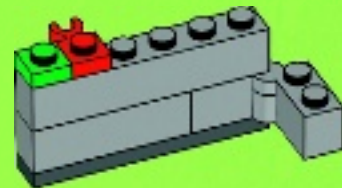

1x



1x



2x

5

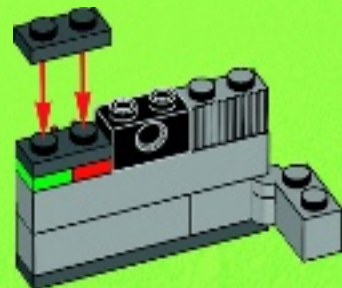

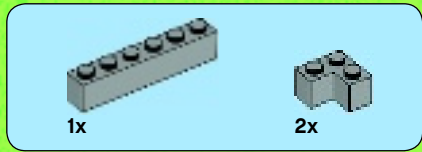

6

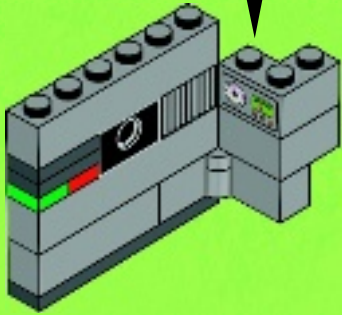
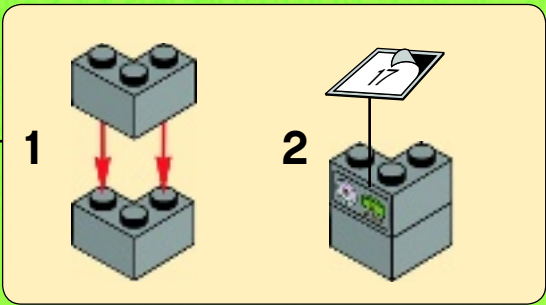

45

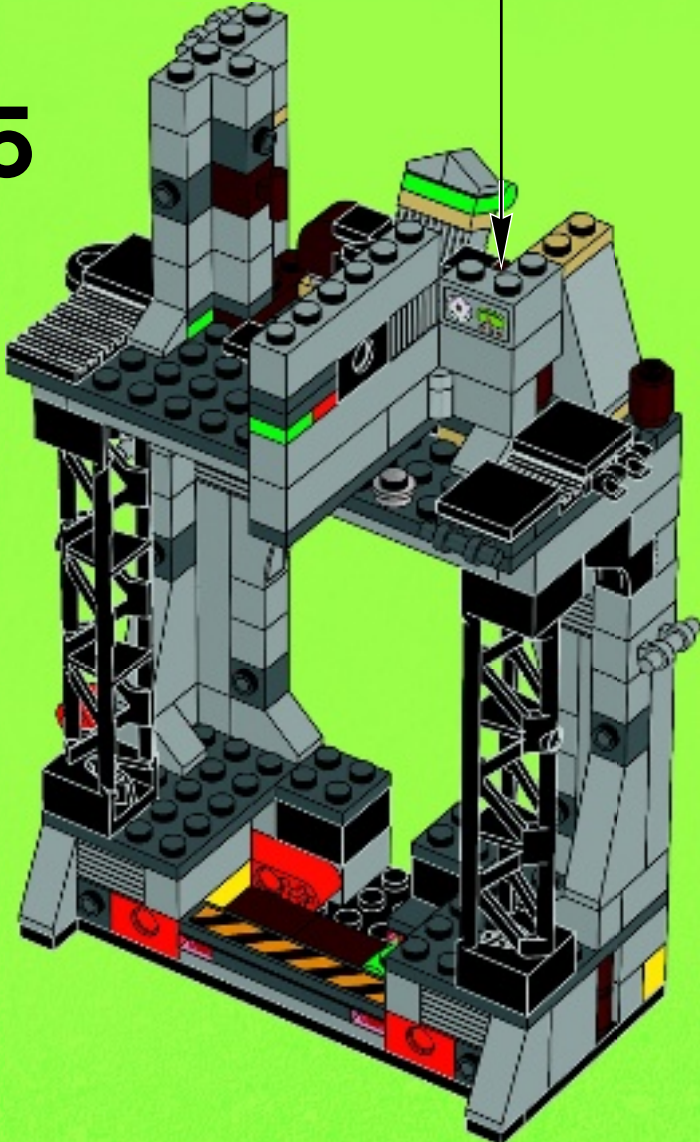



1x



1x

46

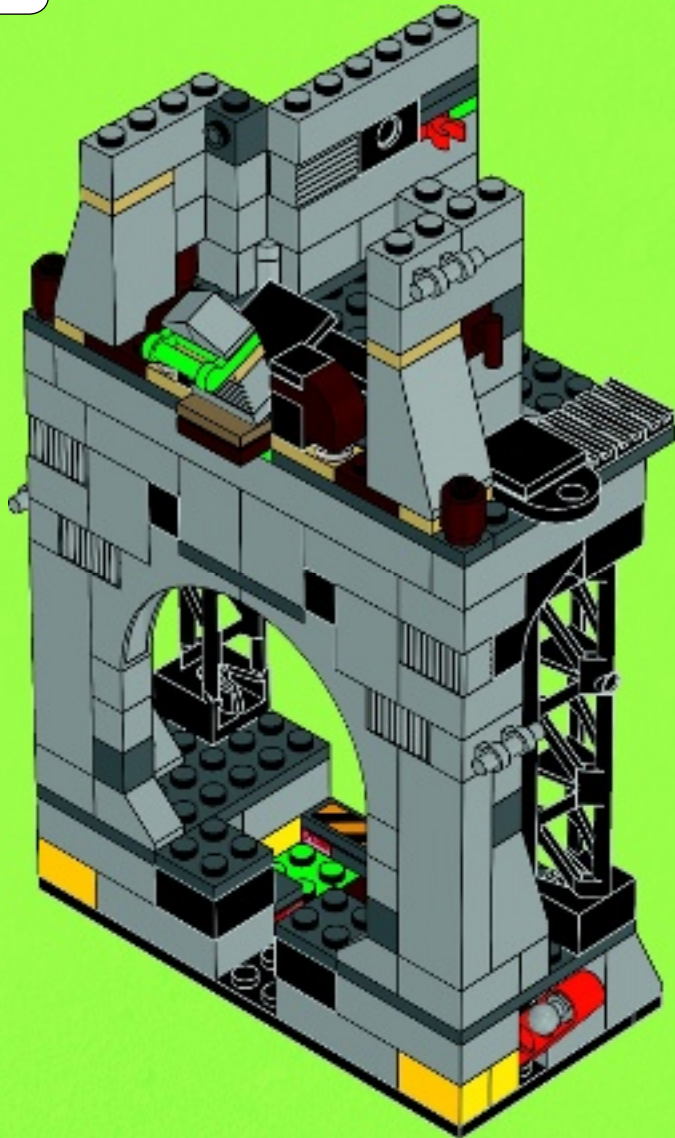



1x



1x

47

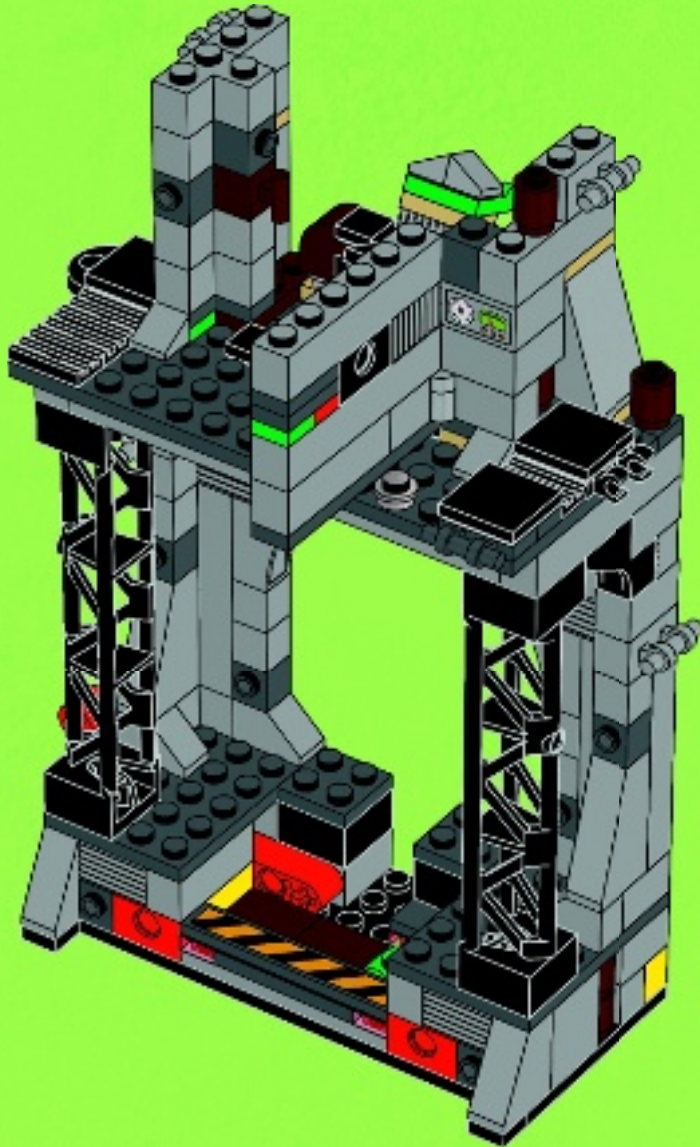

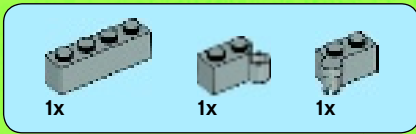

48

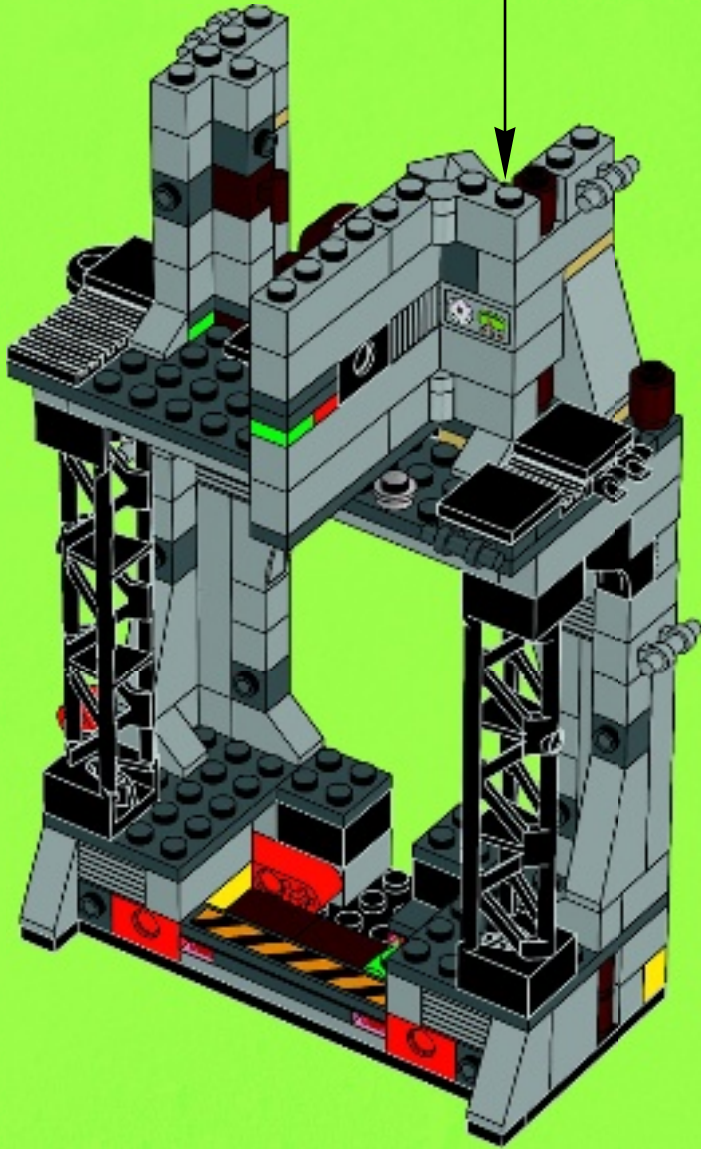
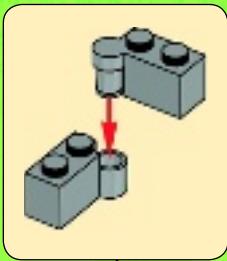



1x



2x

49

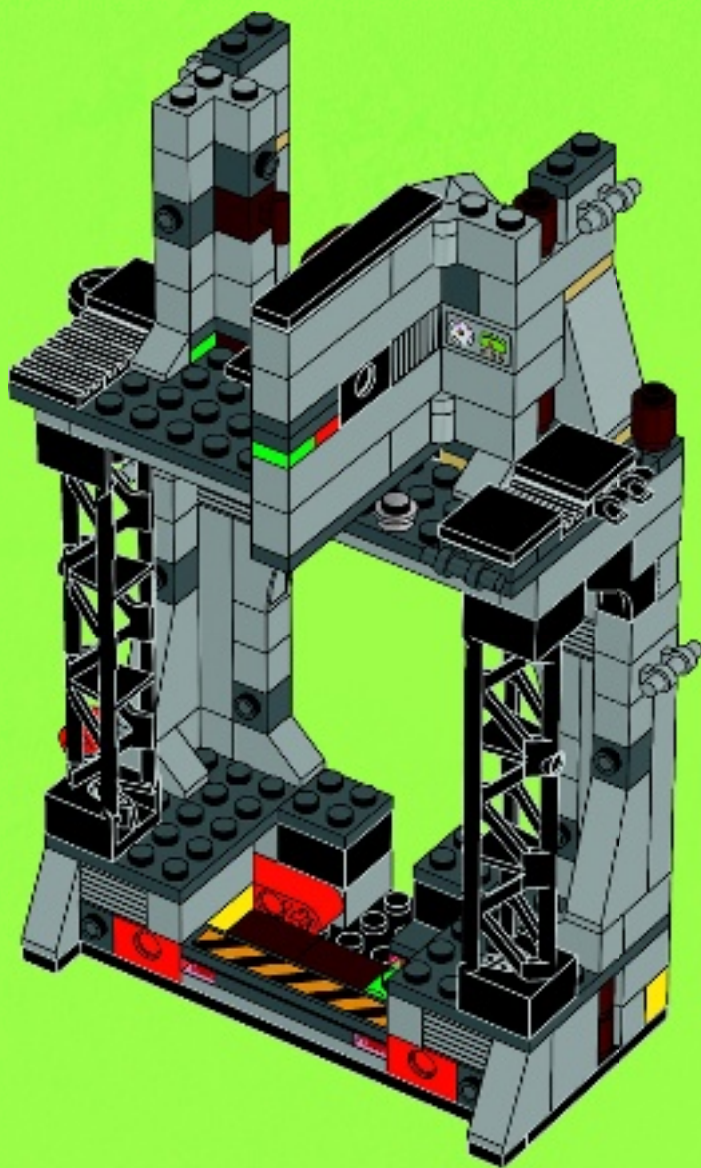



2x

50

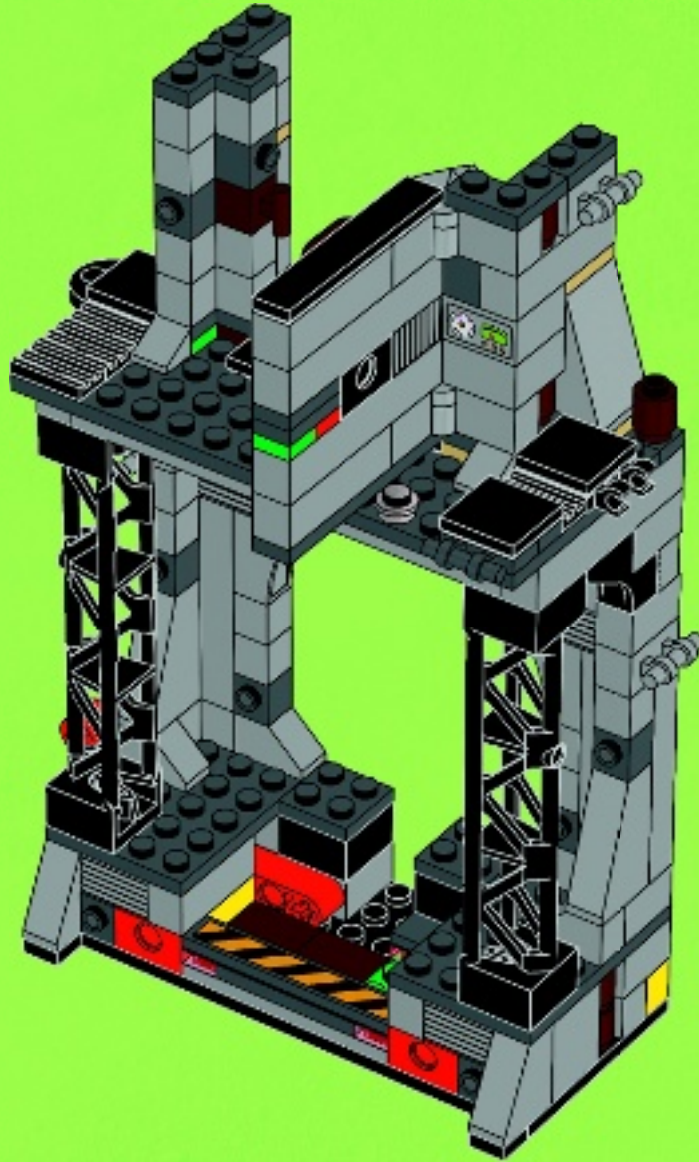



2x



2x

51

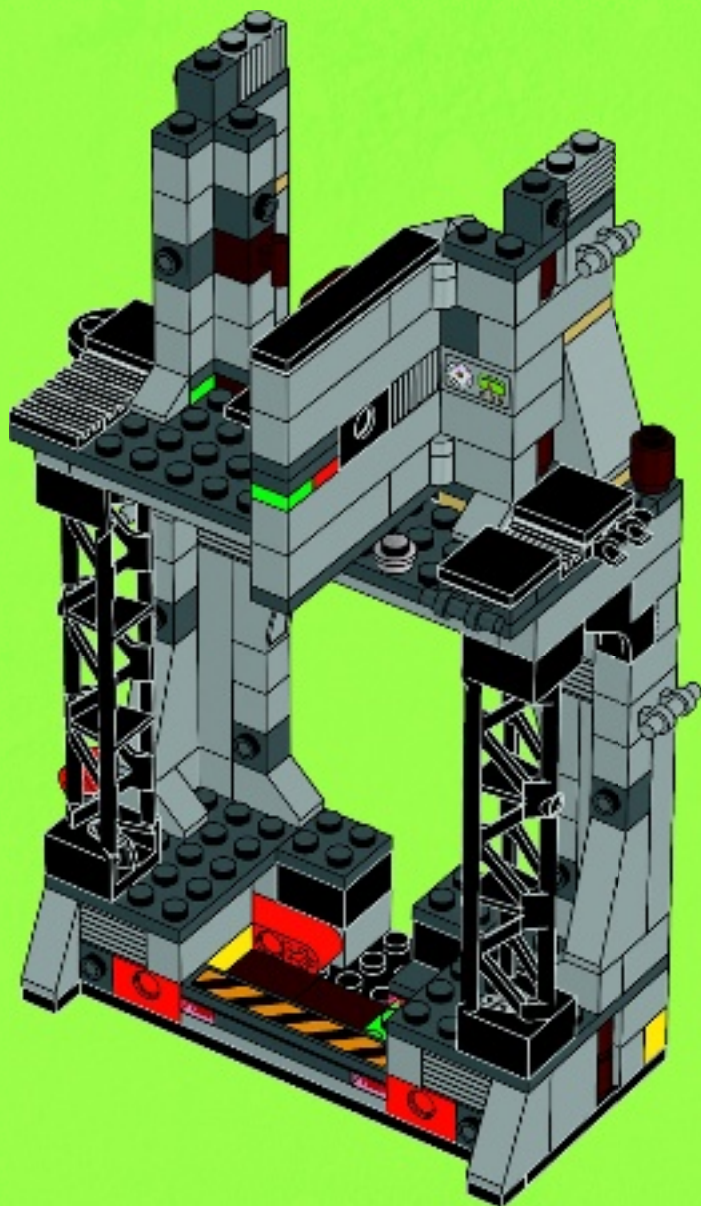

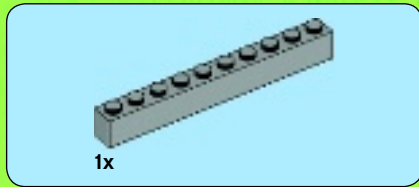

52

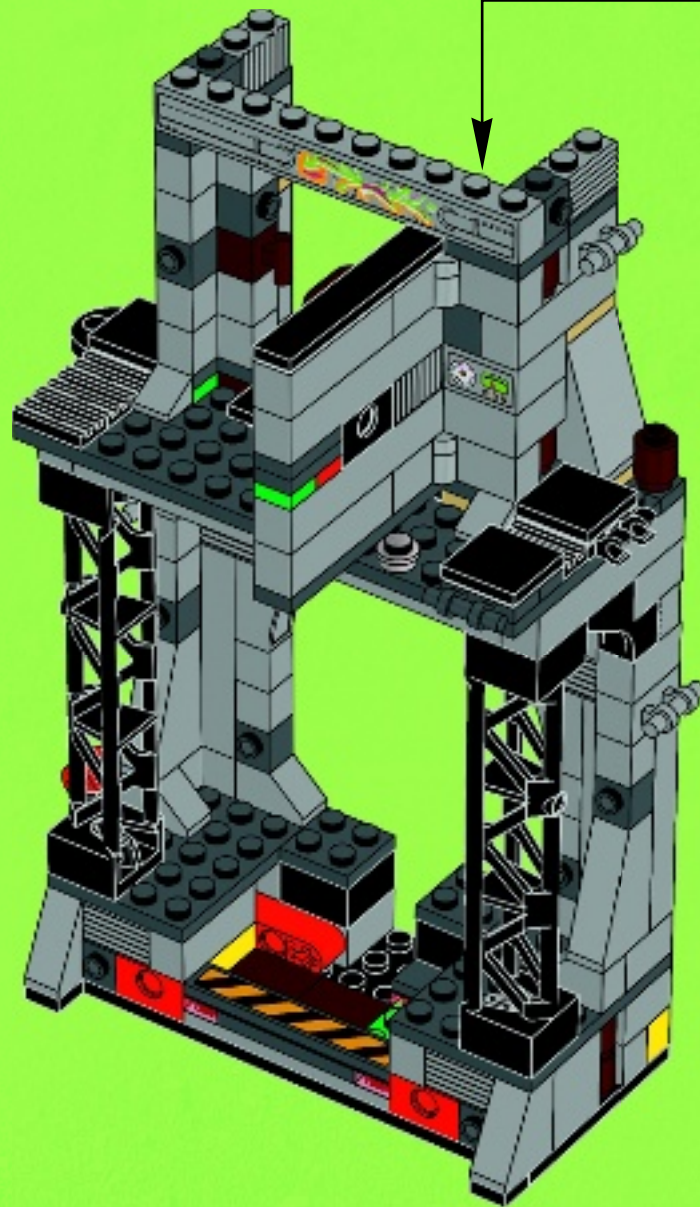
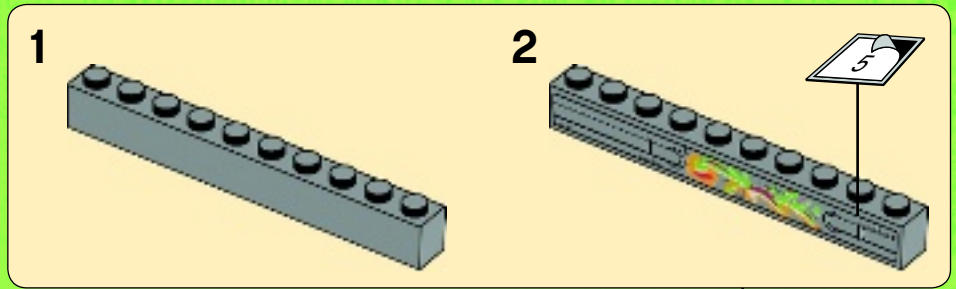



53

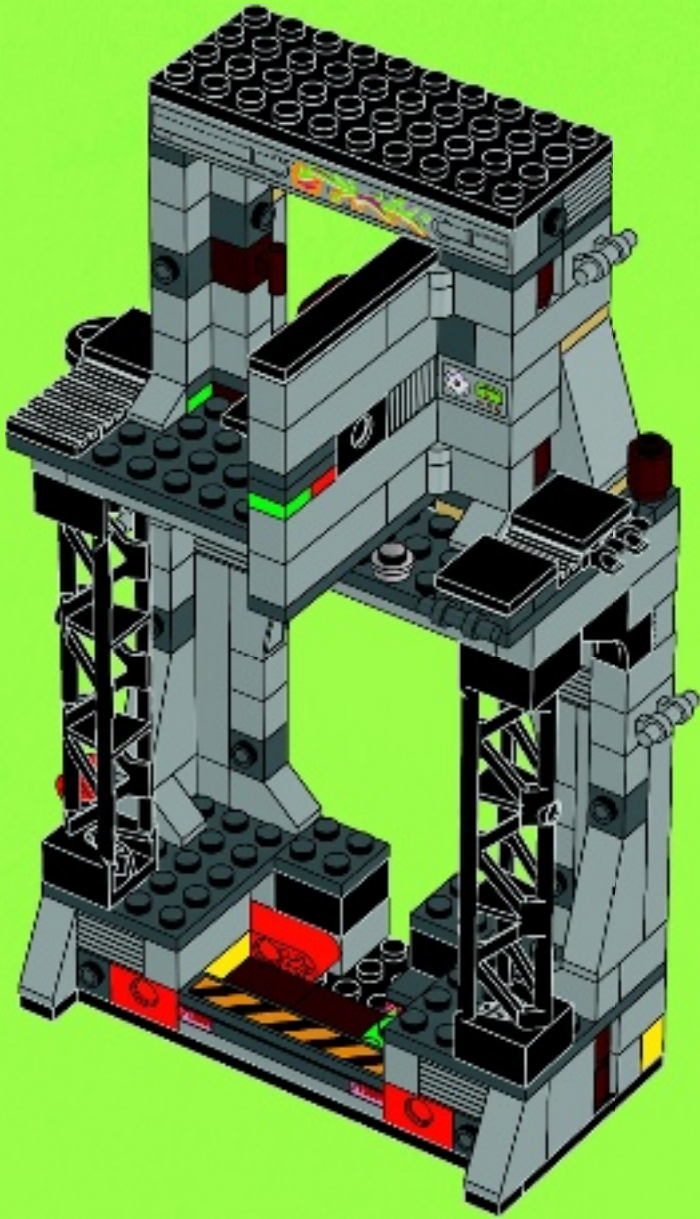

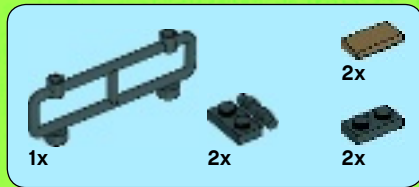

54

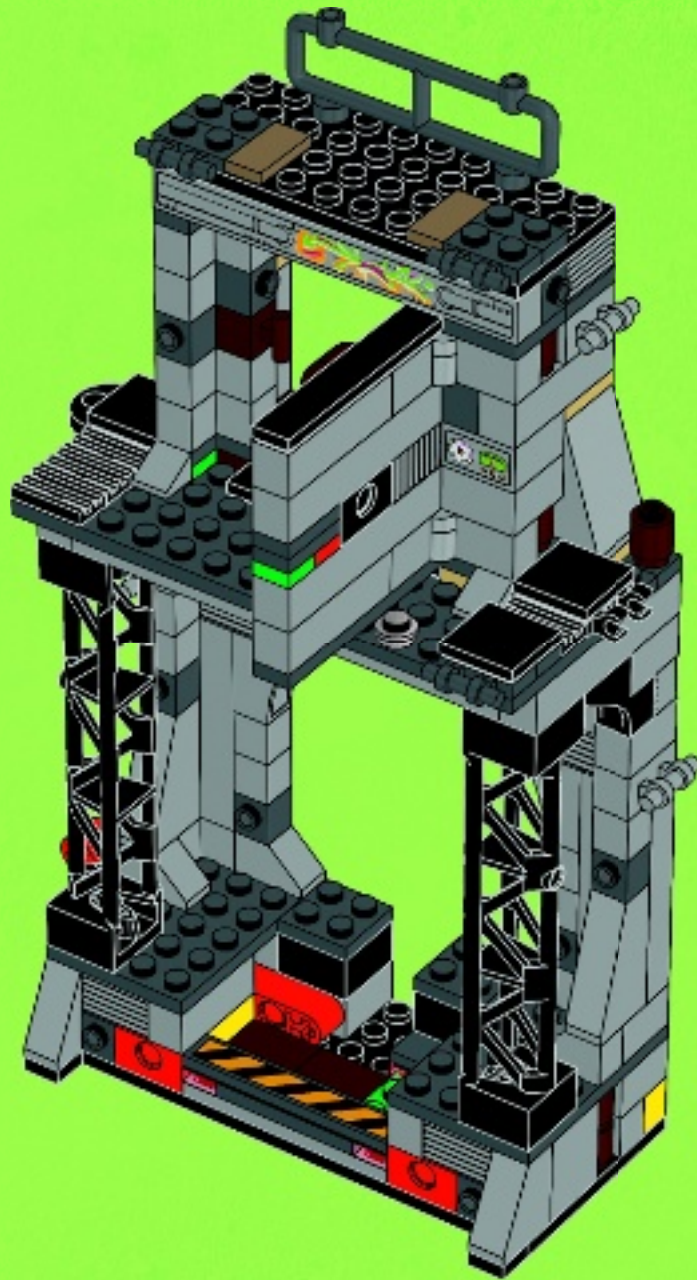



2x



1x

55

1



2

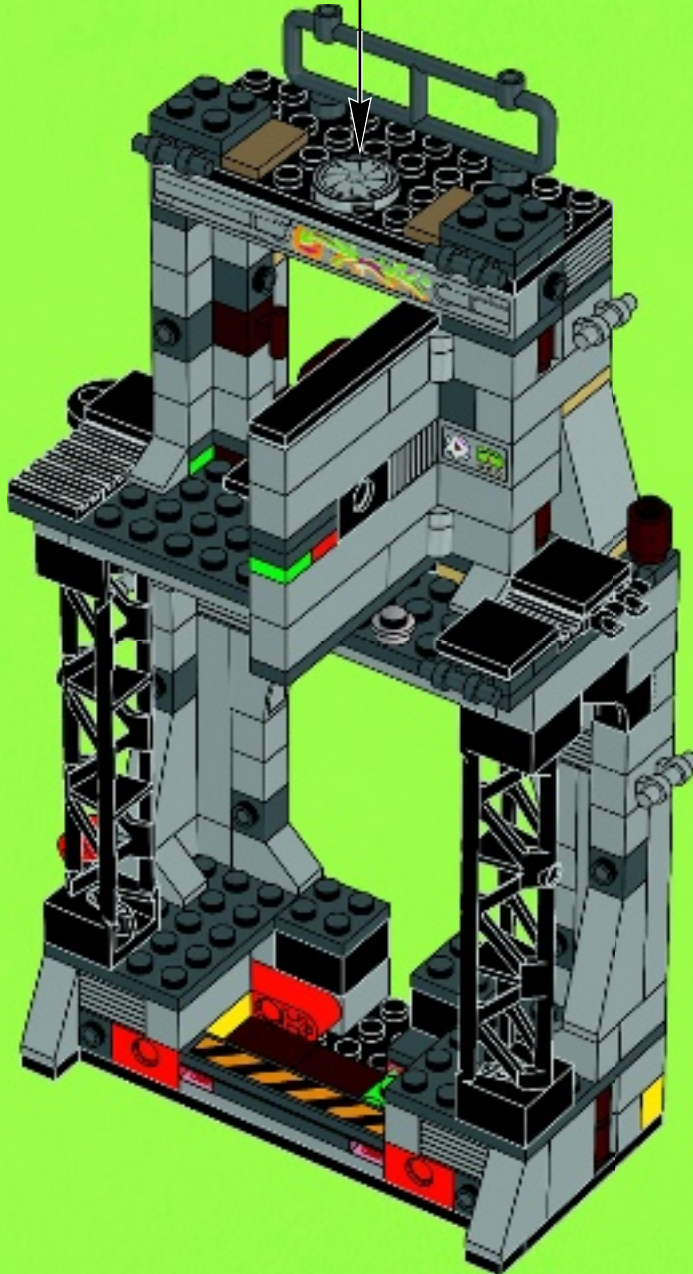
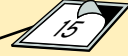



2x 4x 2x

56

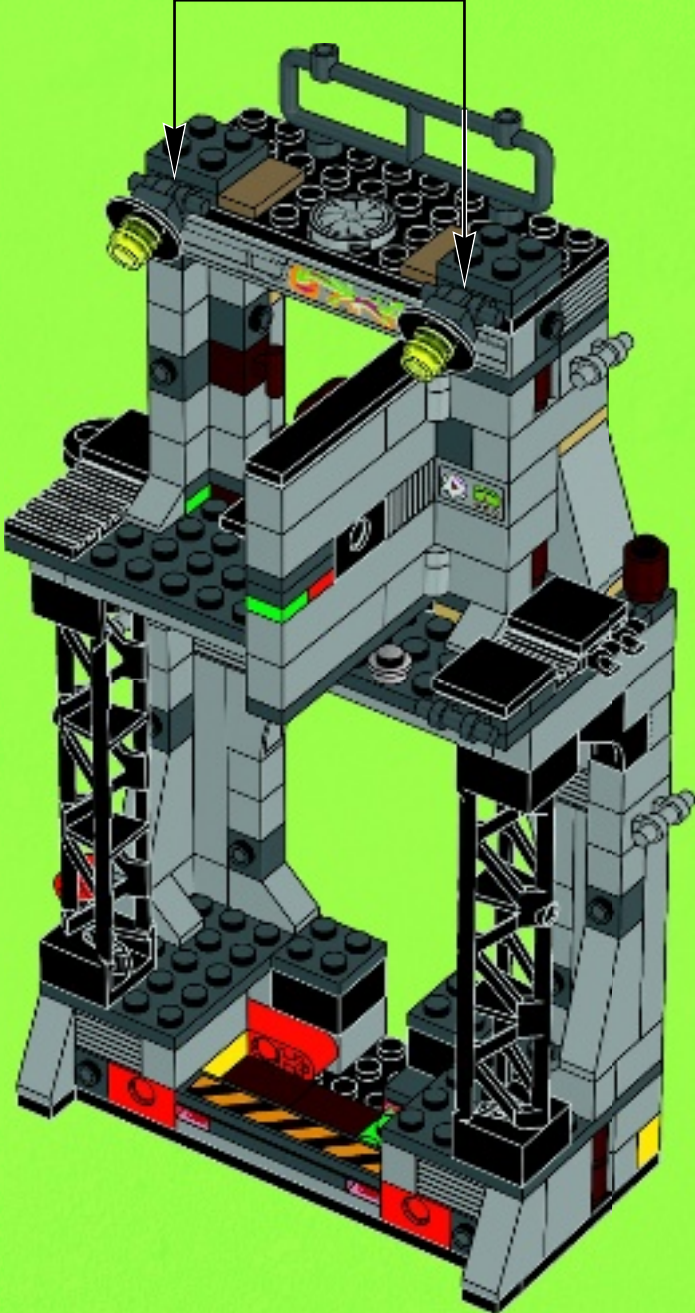
1 2 2x



2x  2x 

 2x

57

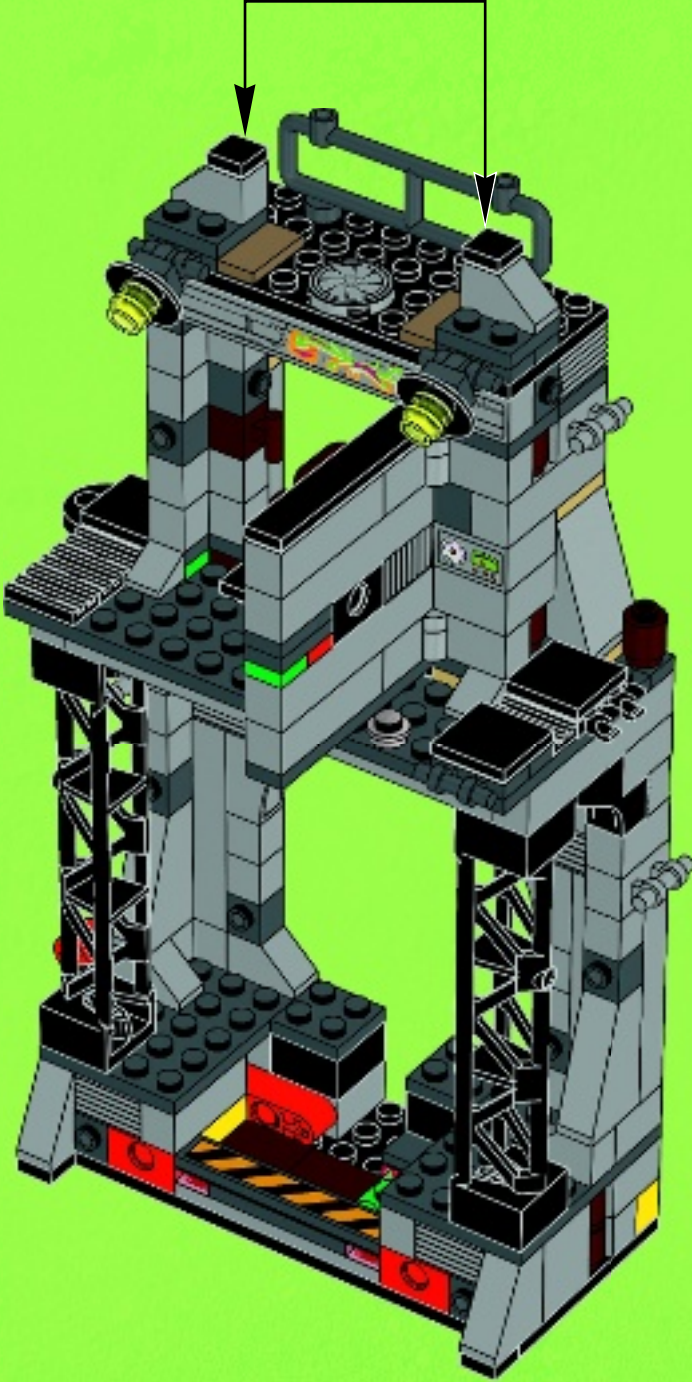

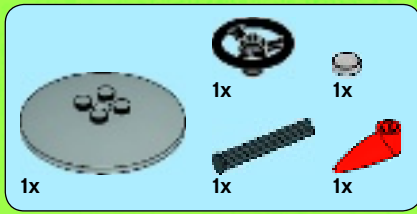

58

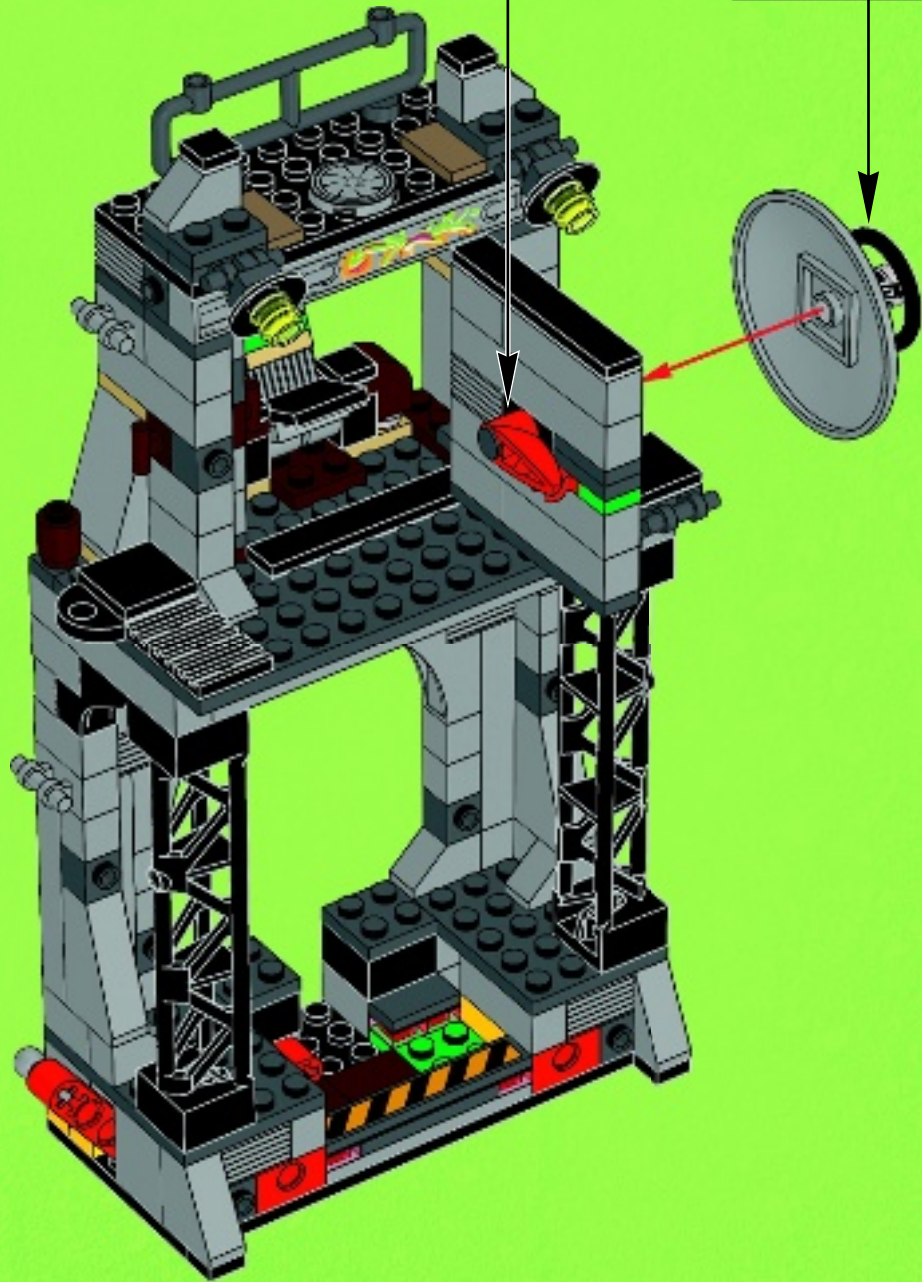
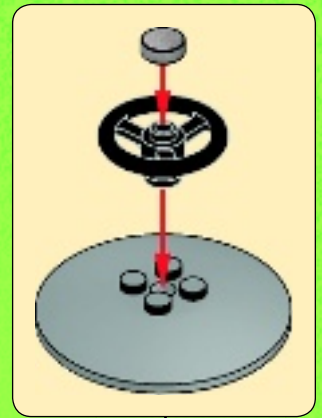
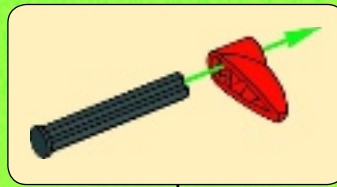

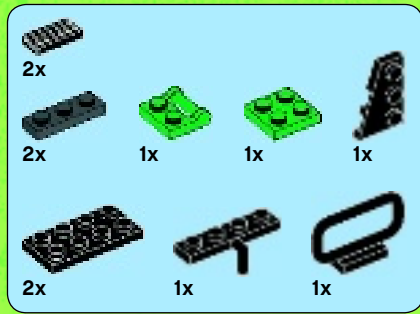

59

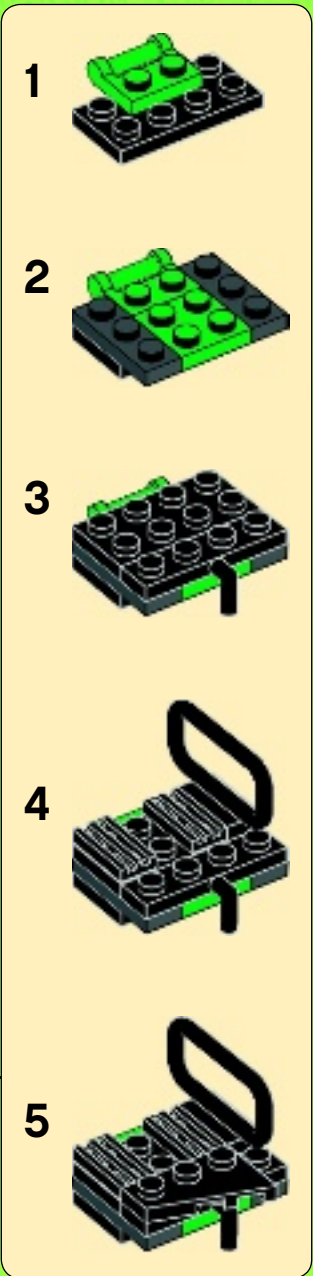
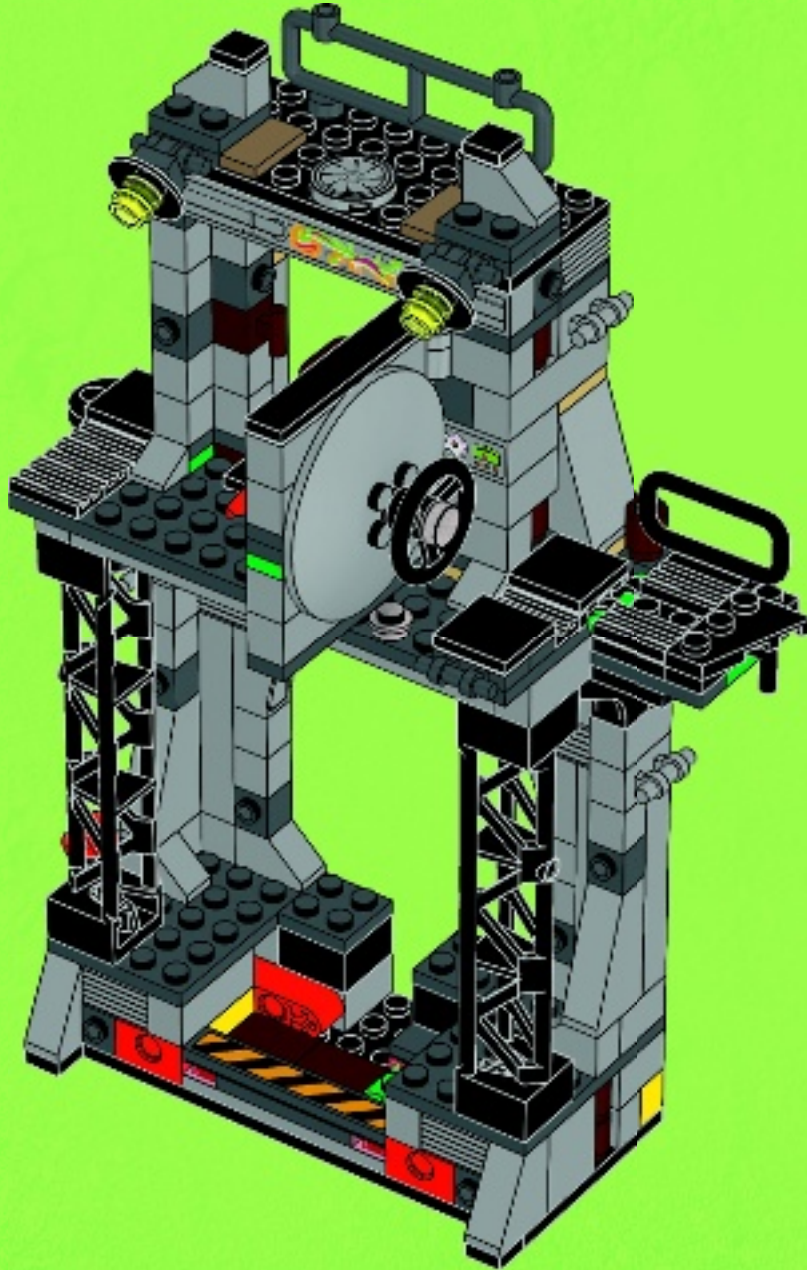

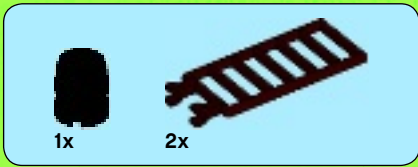

60

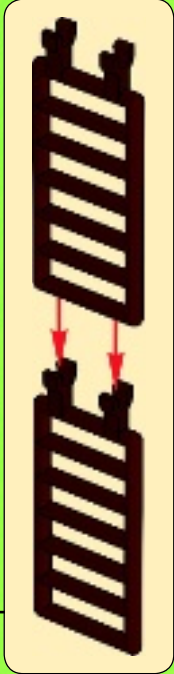
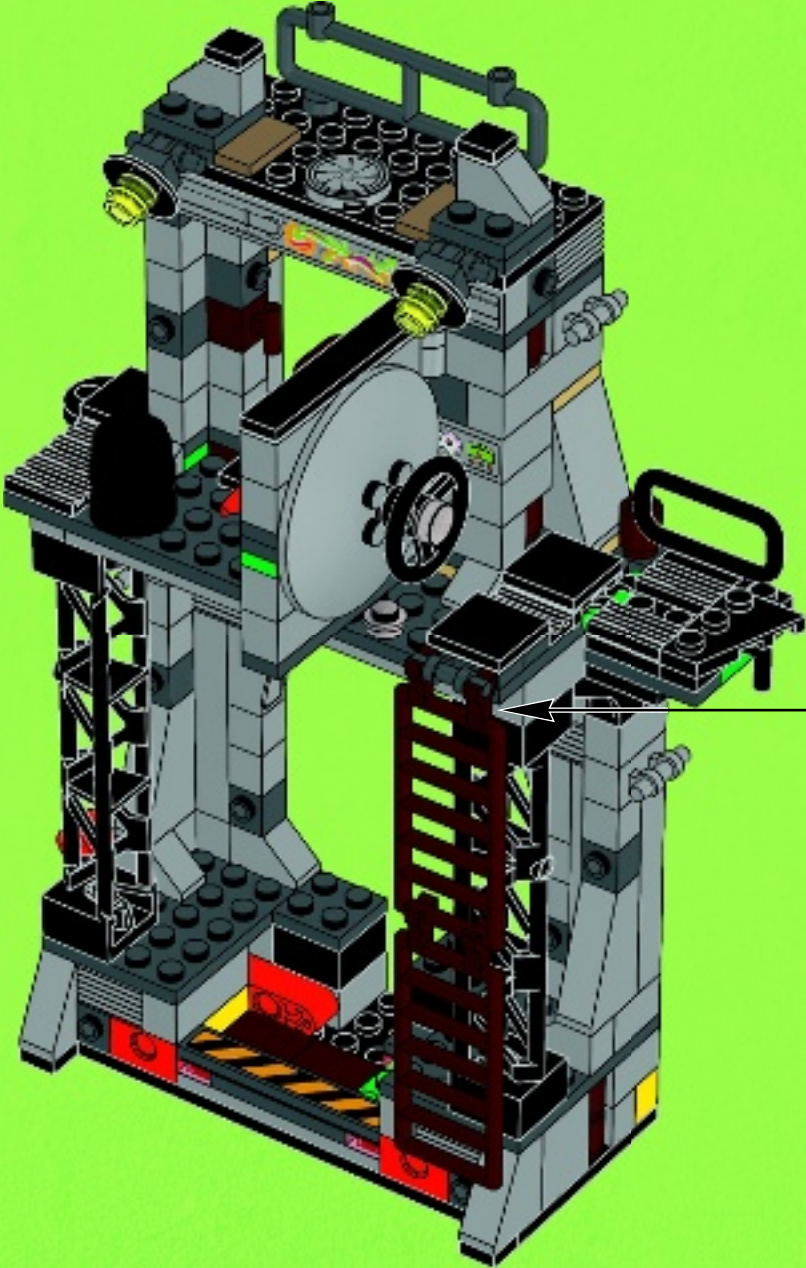



1x

61

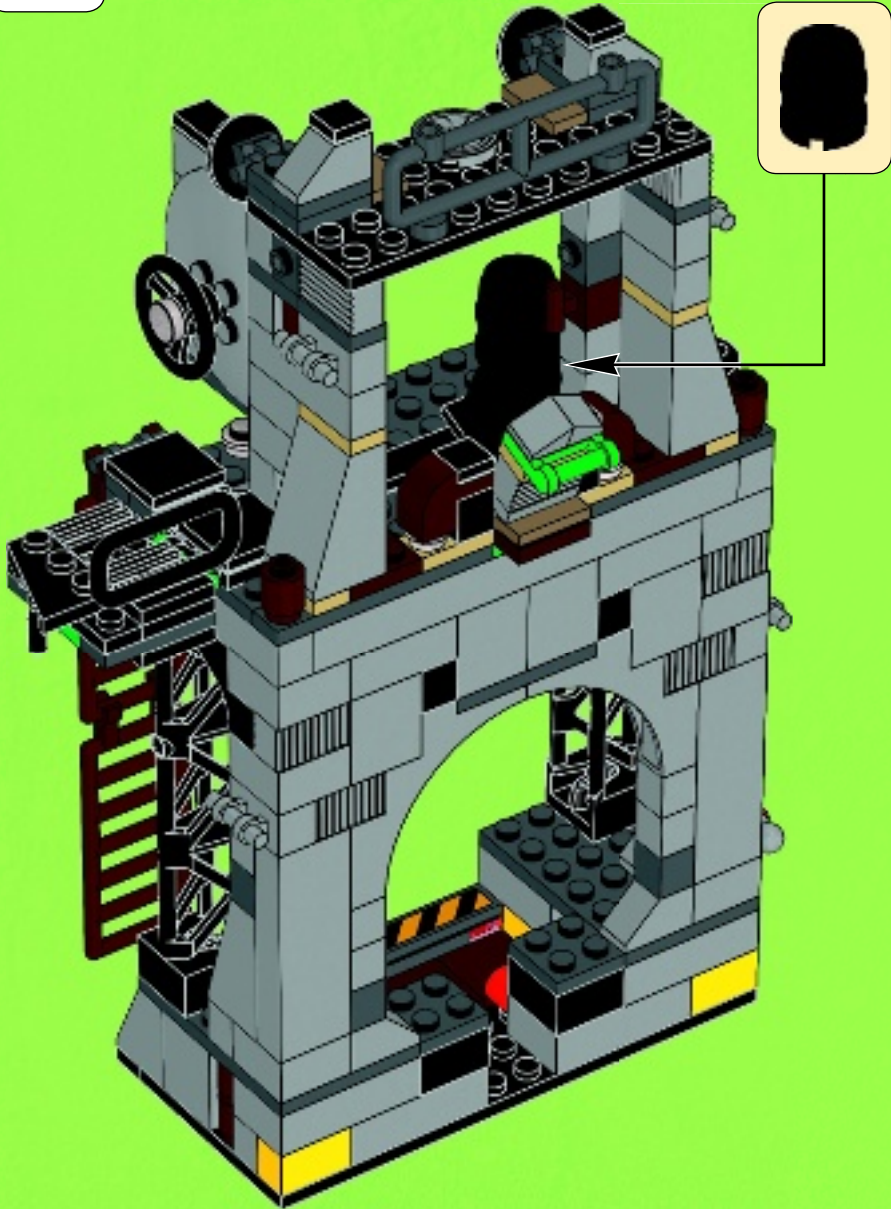

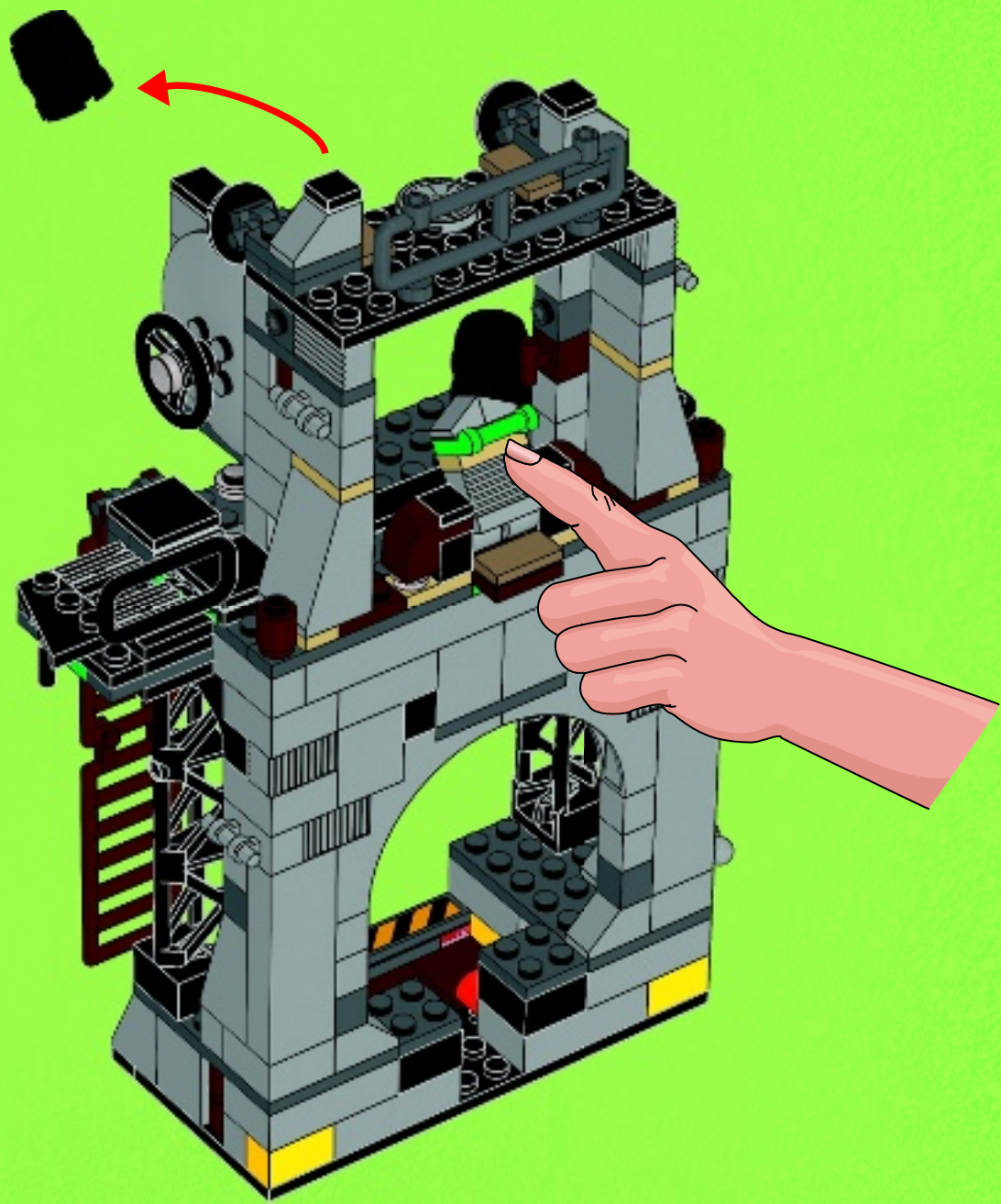

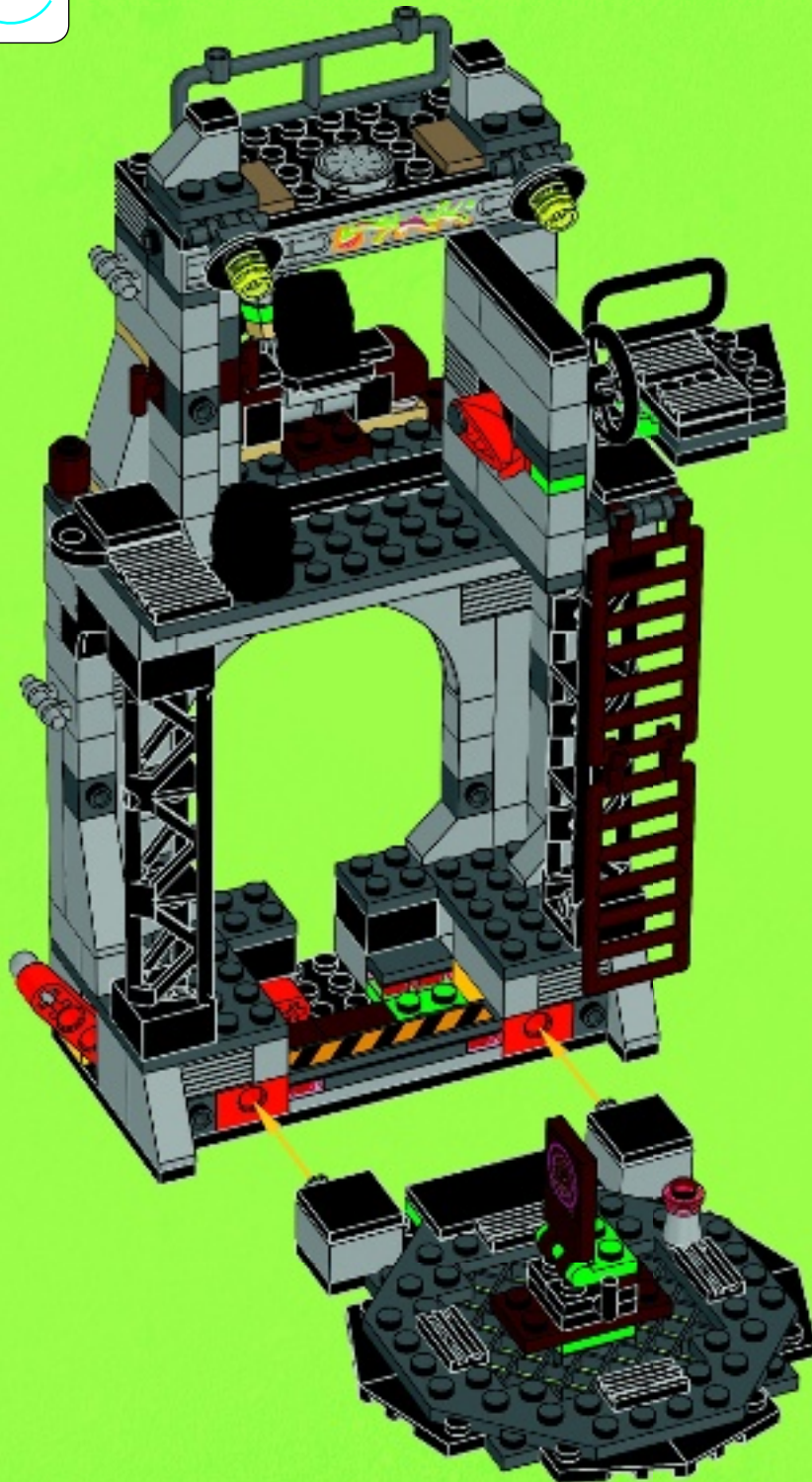

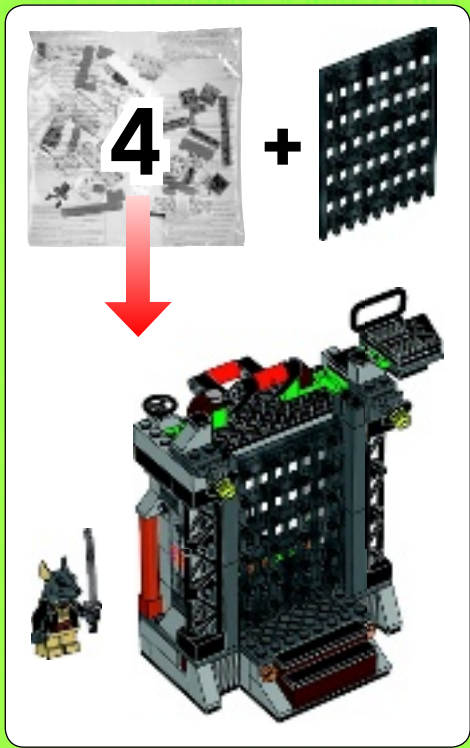

1

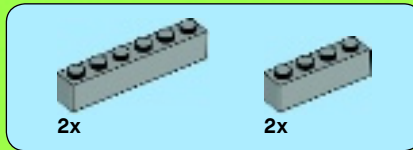

2

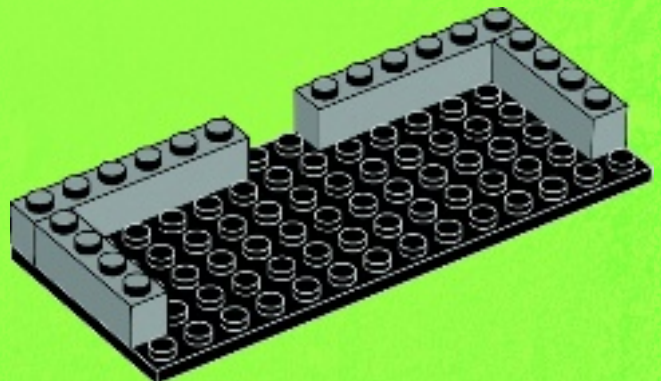

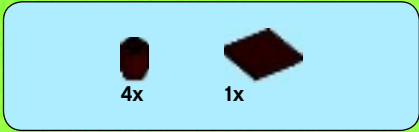

3

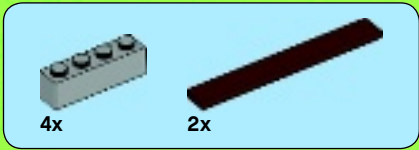
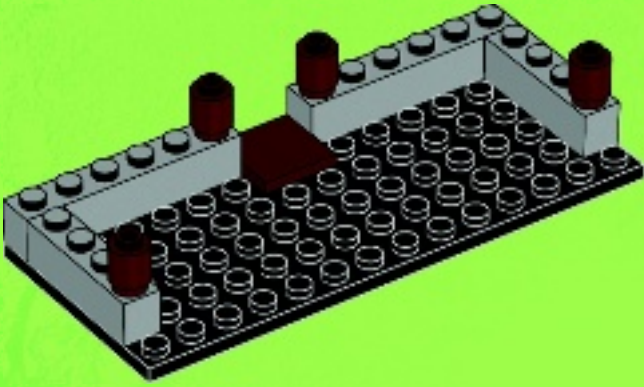

4

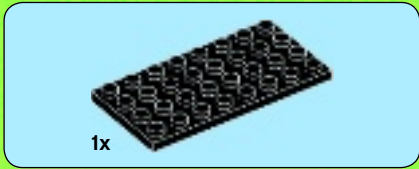
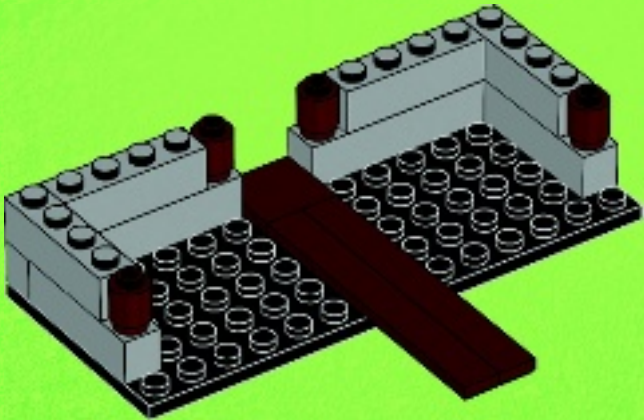

5

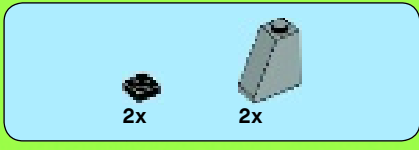
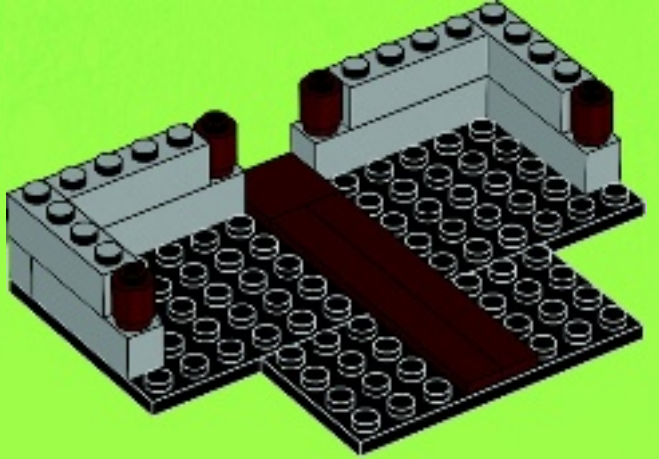

6

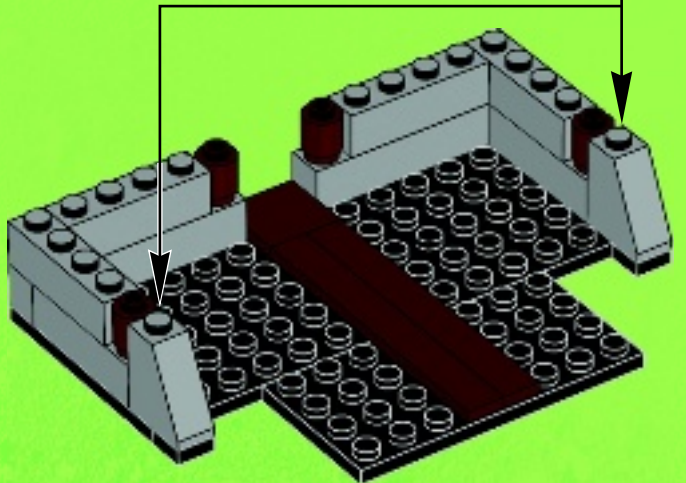
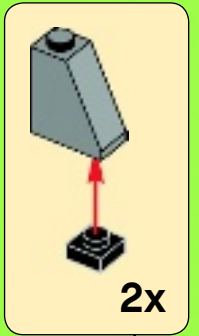

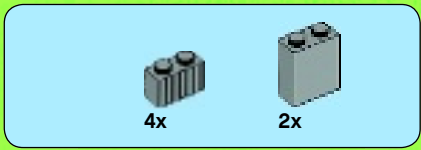

7

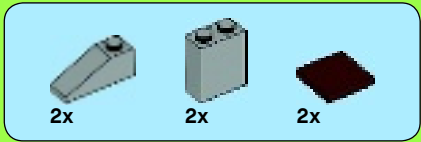
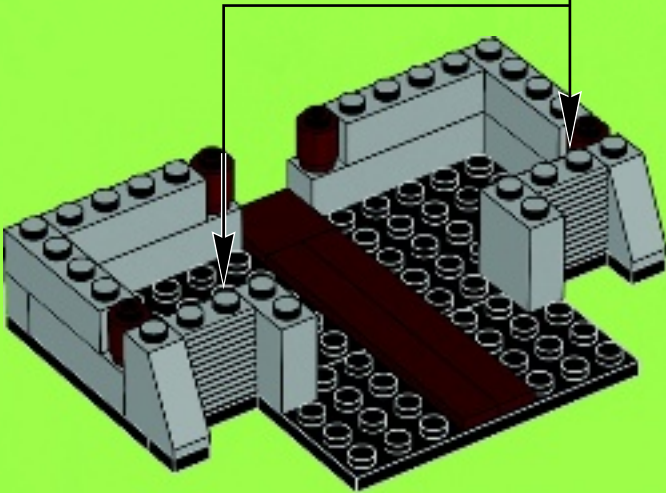
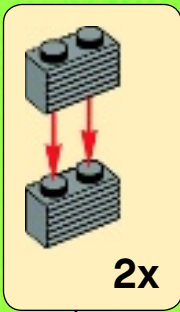

8

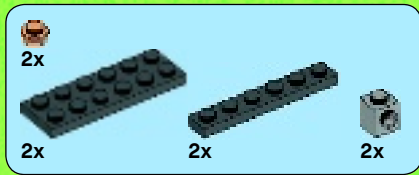
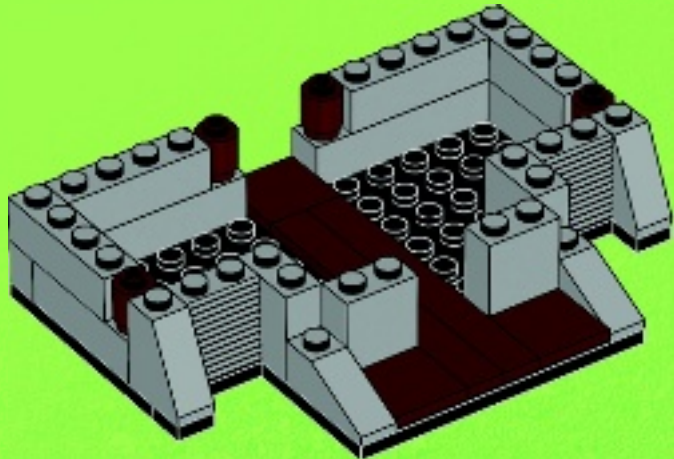

9

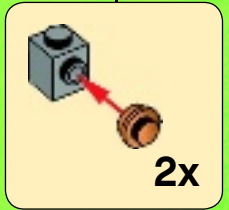
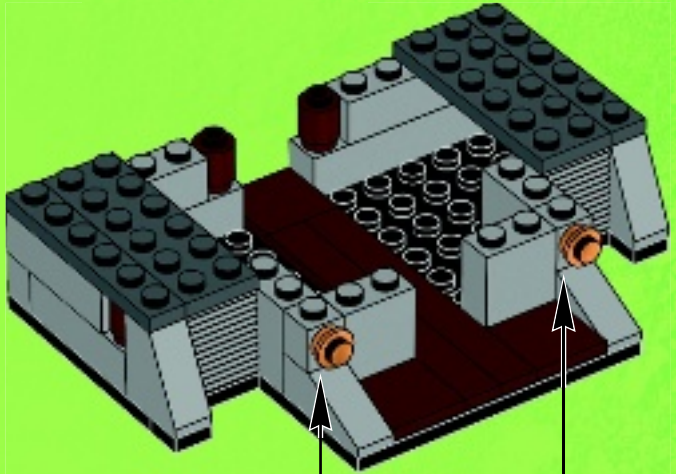

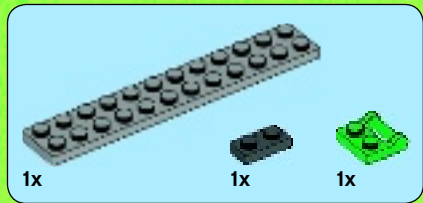

1

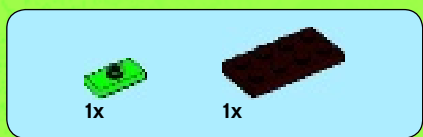
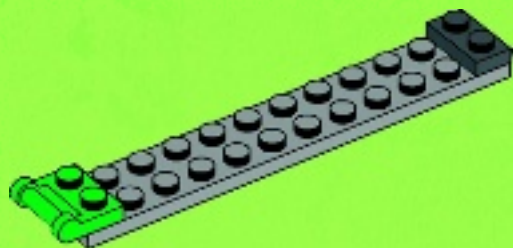

2

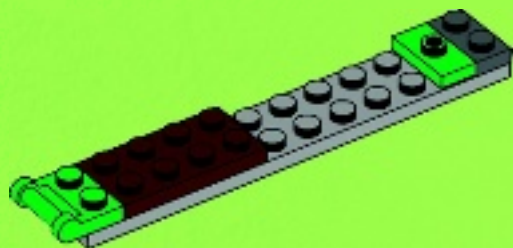

3

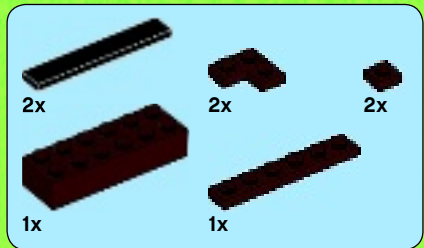
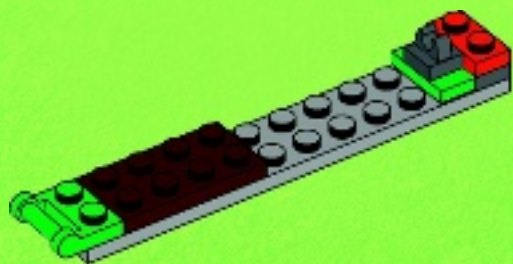

4

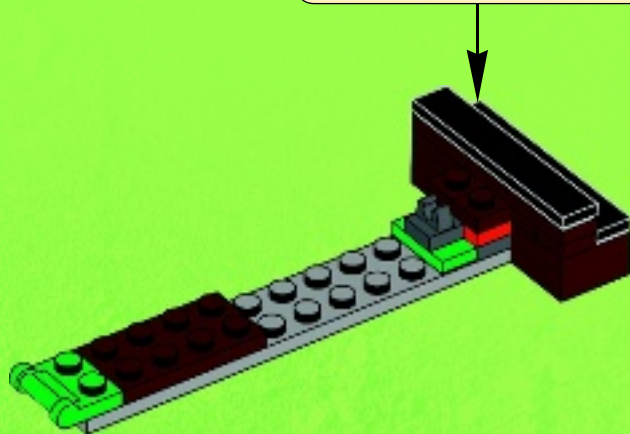
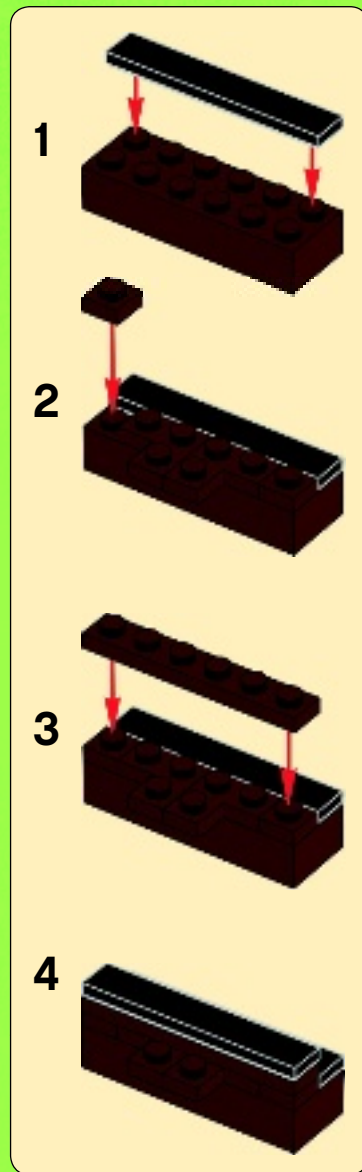

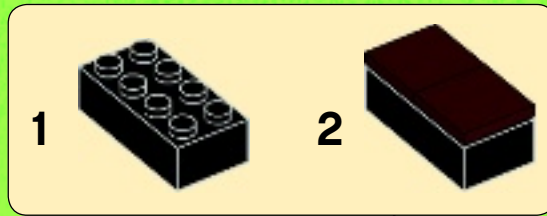
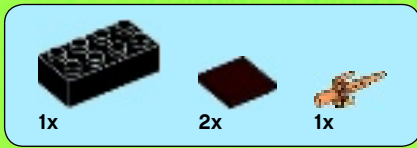

5

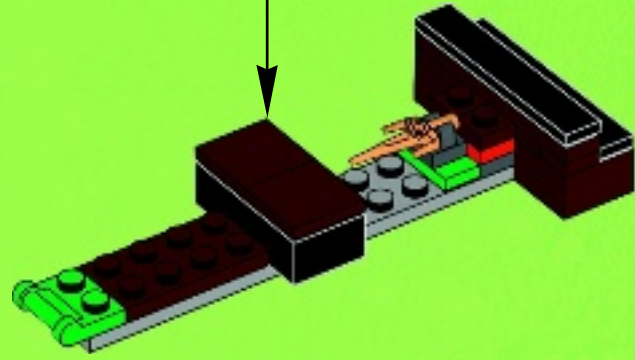

10

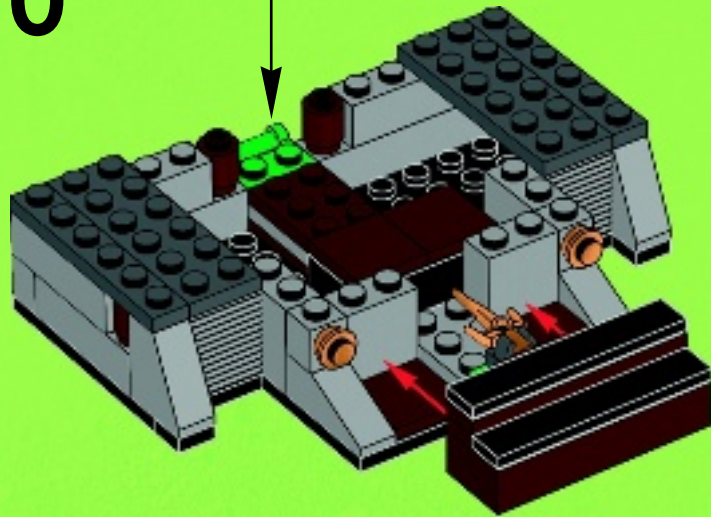



1x

11

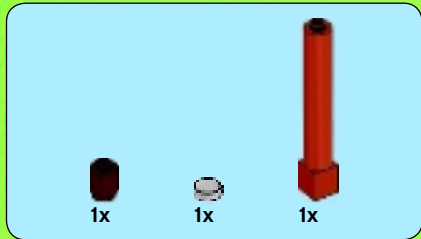
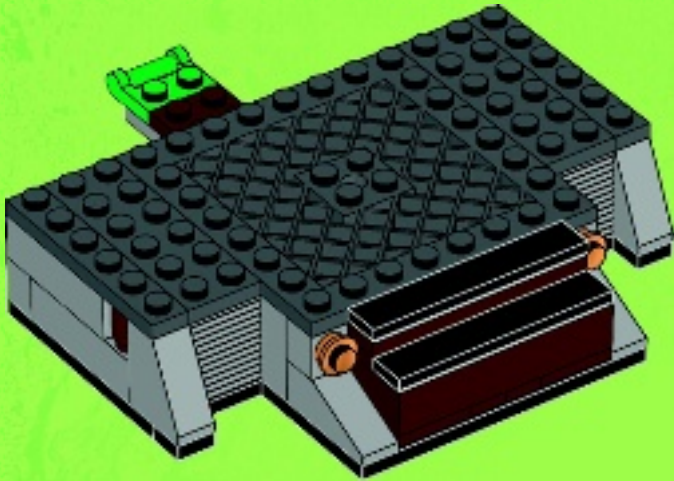

1x

1x

1x

12

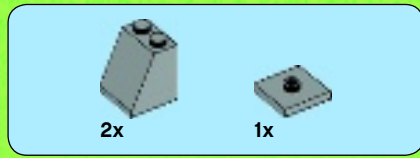
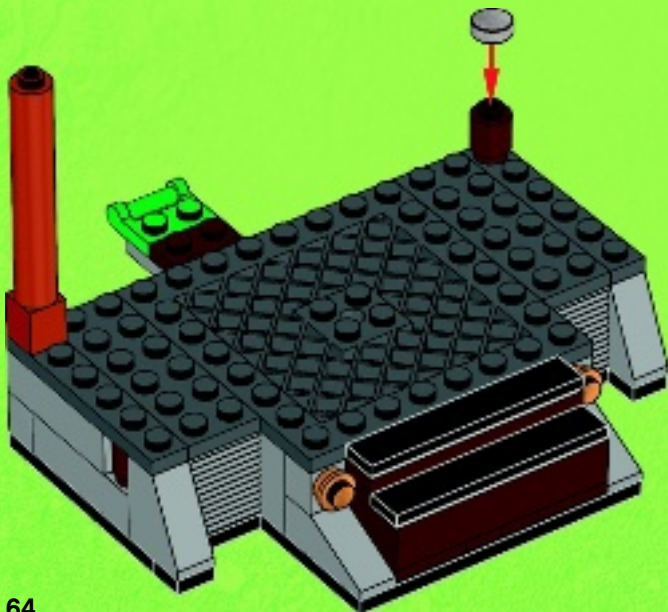

2x

1x

13

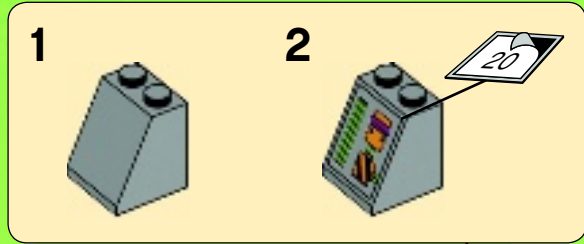

1

2

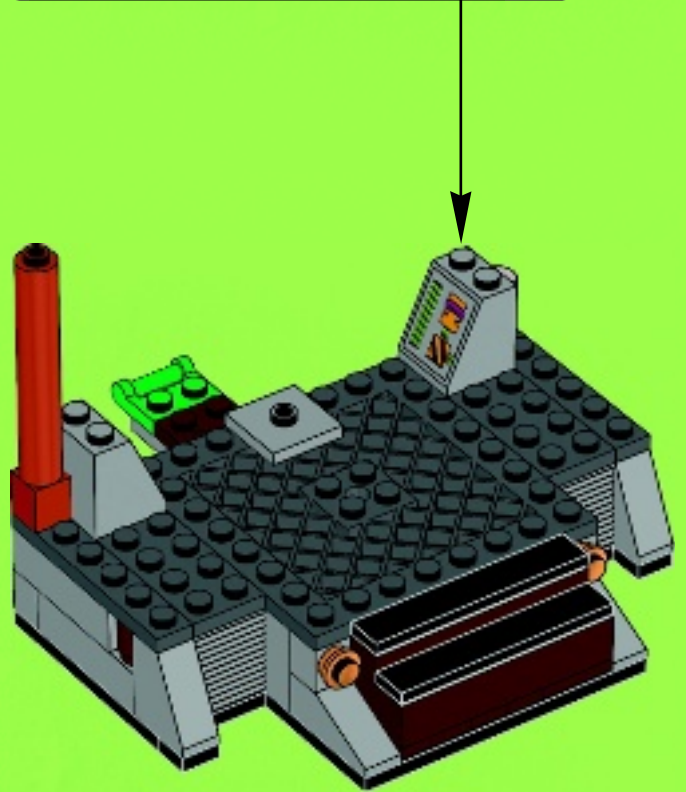



2x

14

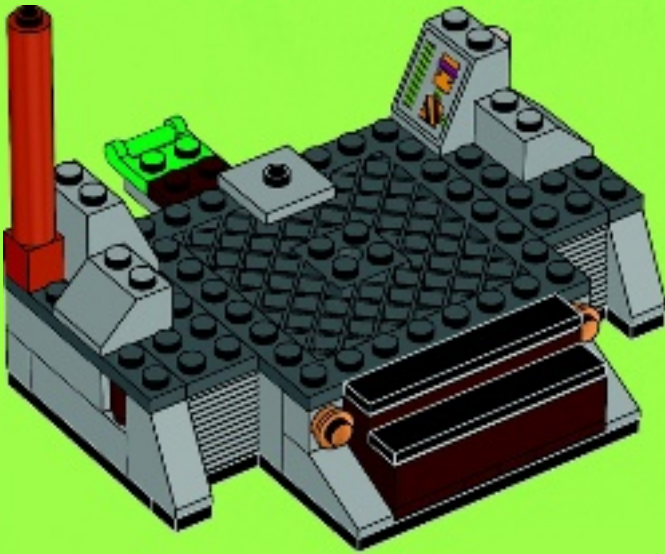

2x



2x

15

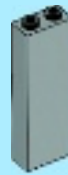

3x



1x



1x

16

1



2

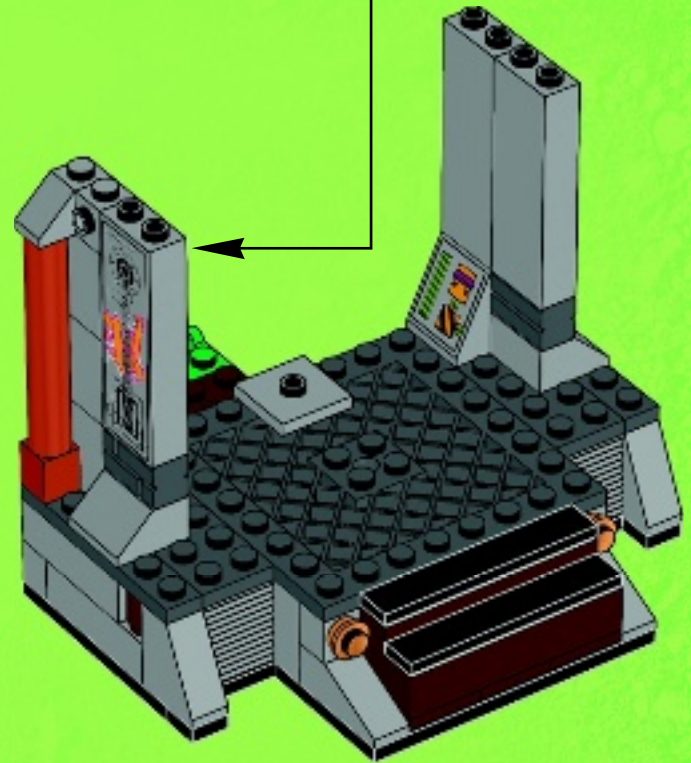

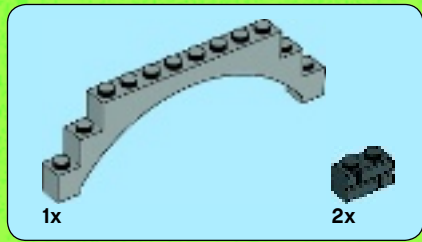

17

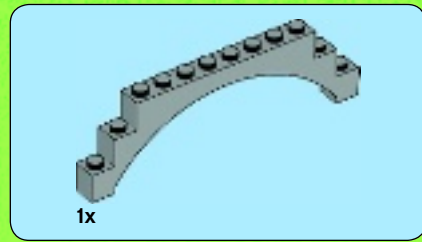
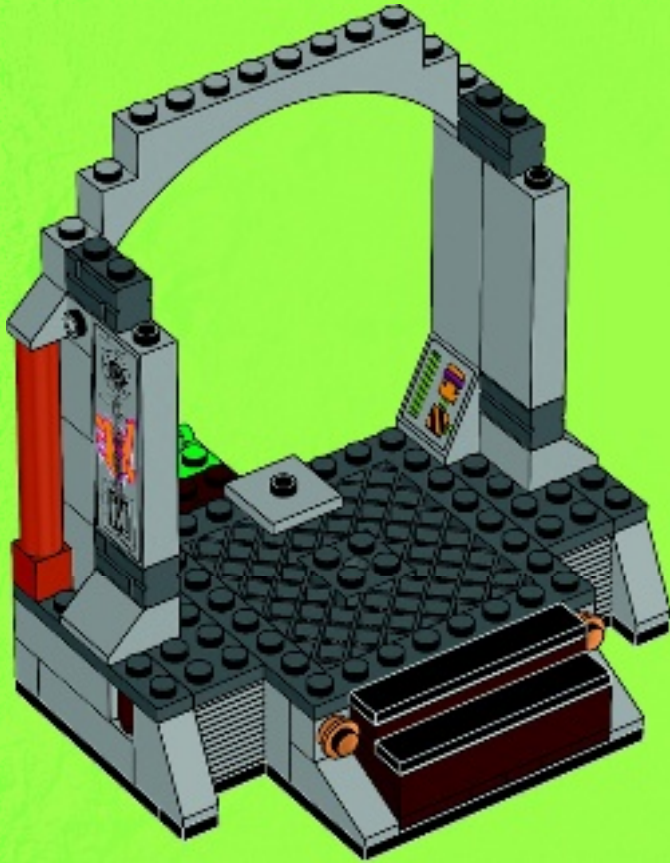

18

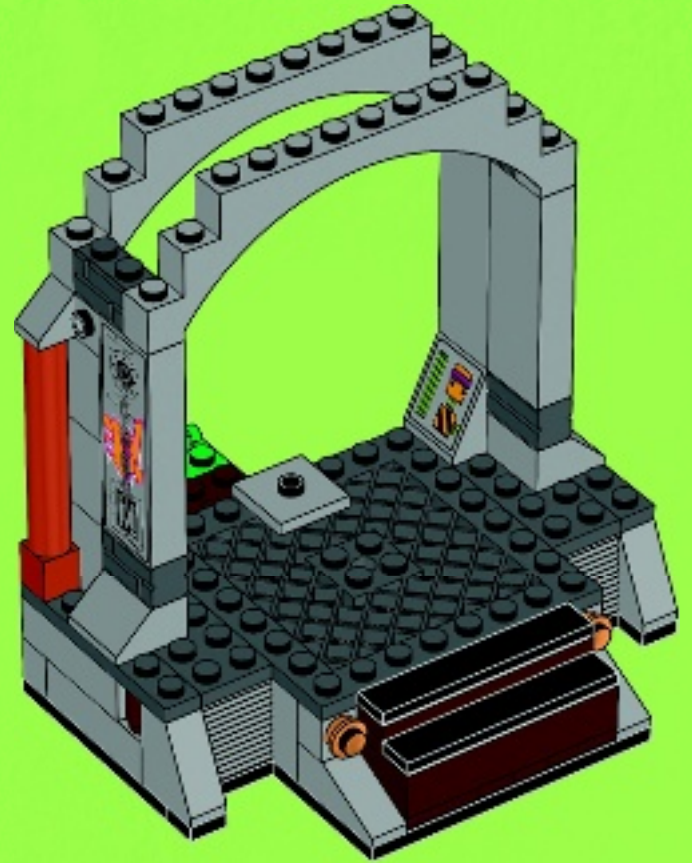



2x



4x

19

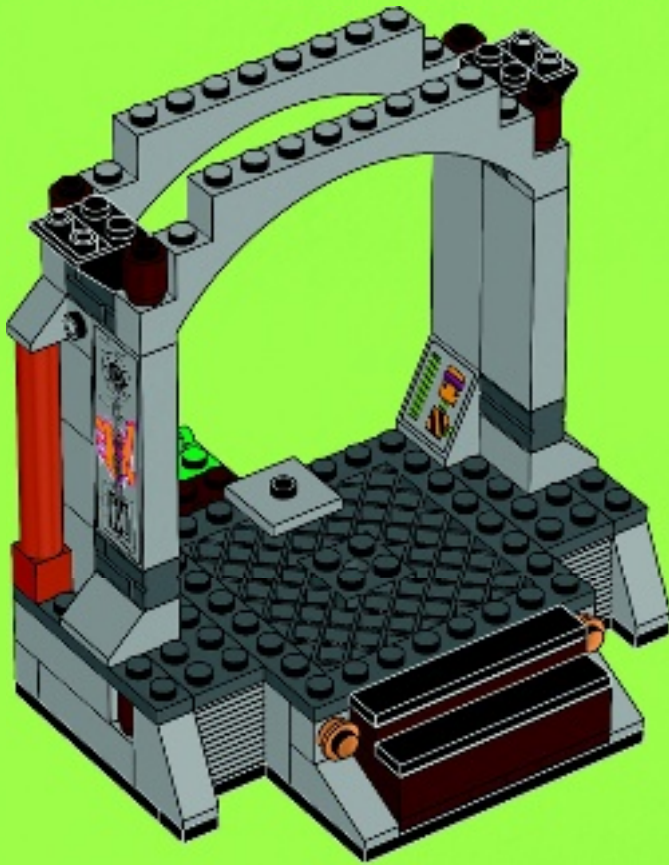

2x



2x

20

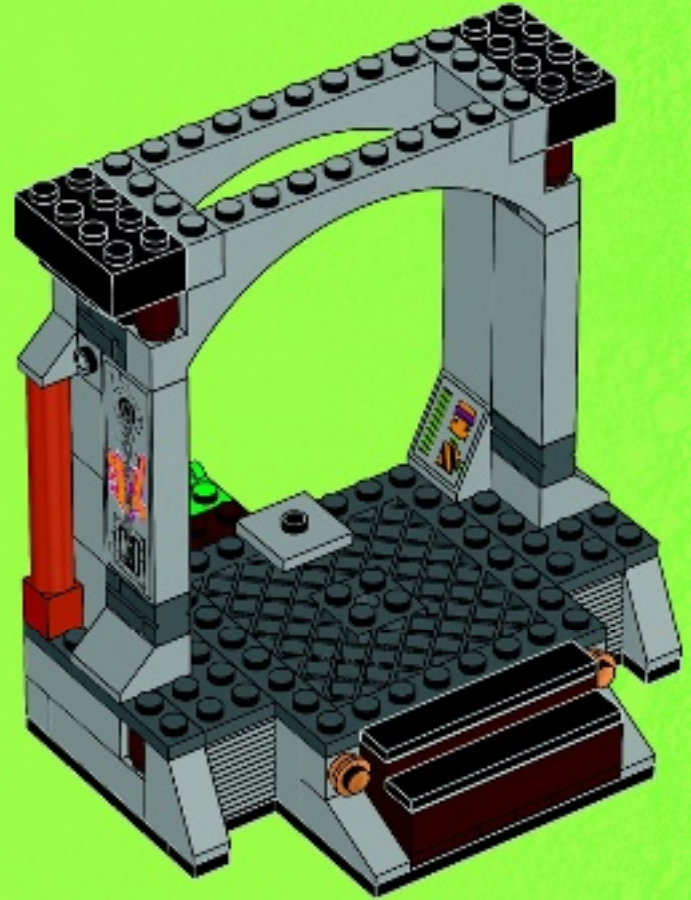

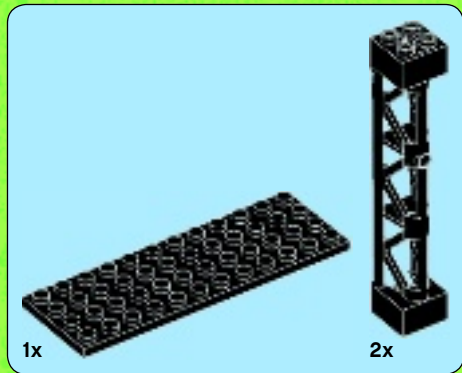

21

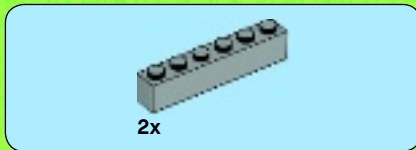
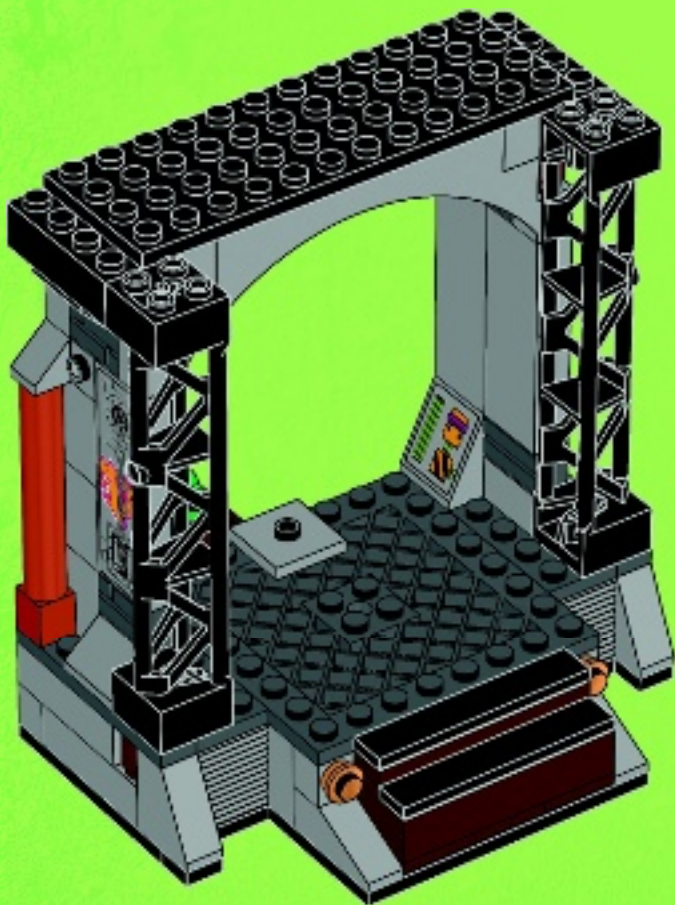

22

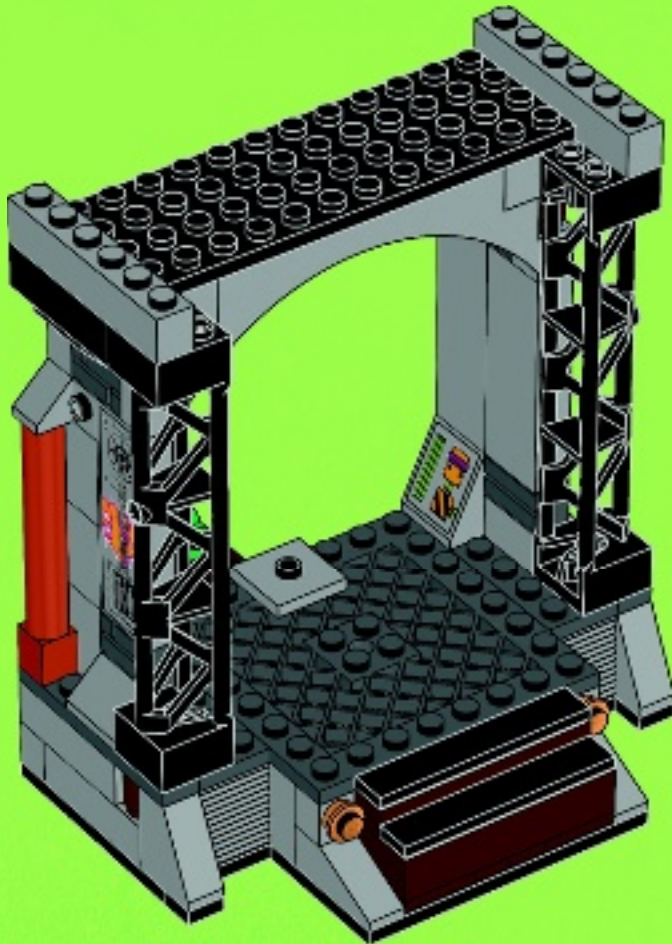



23

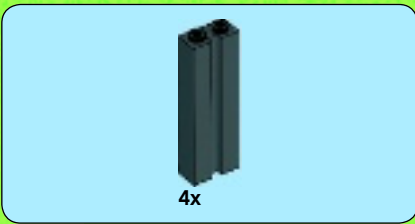
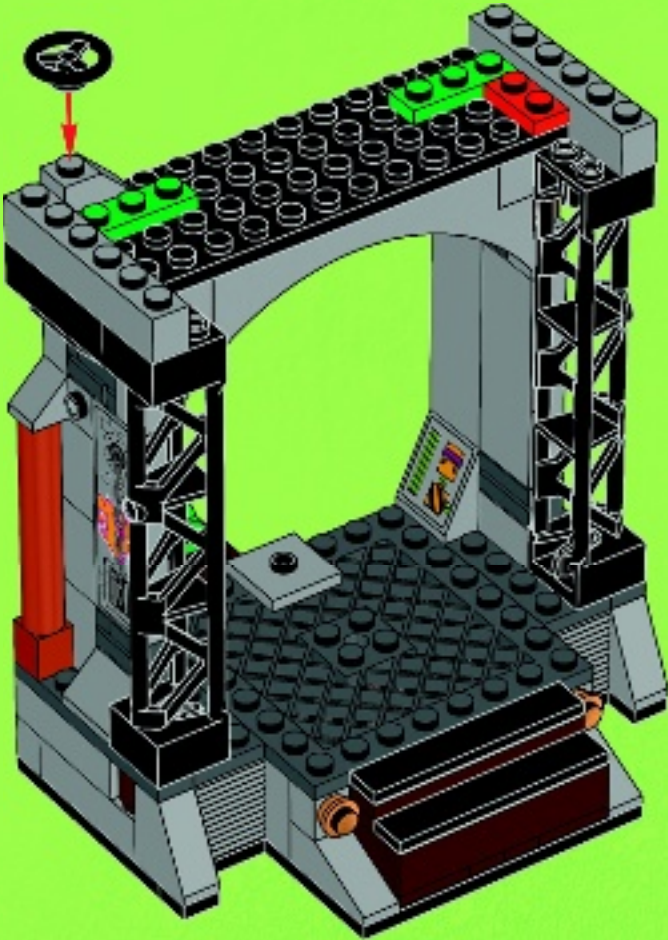

24

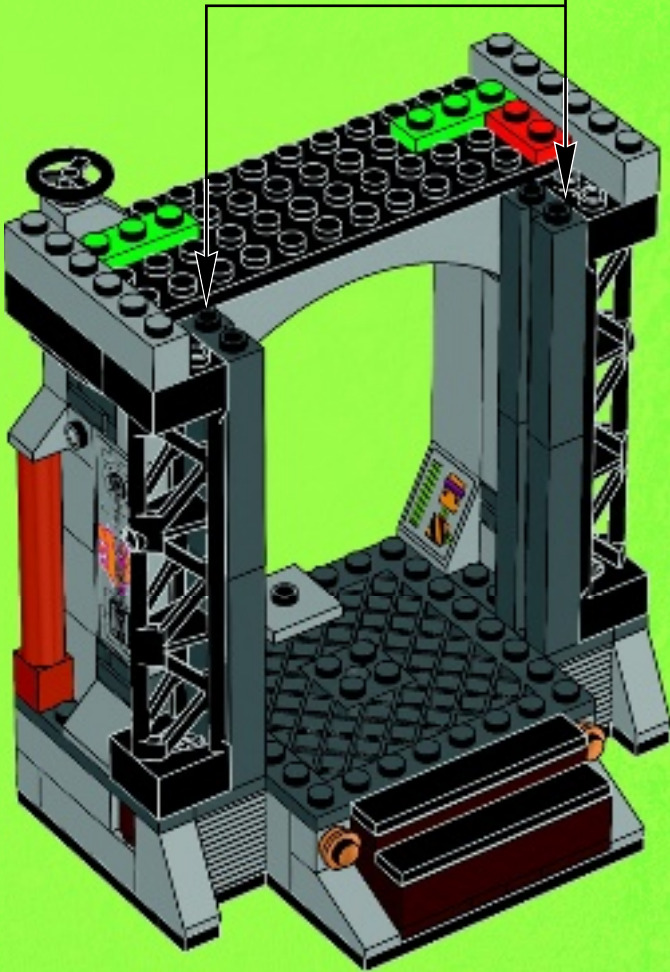
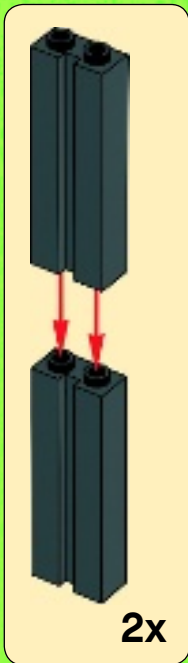

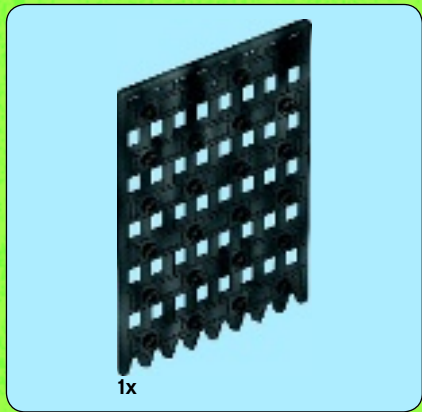

25

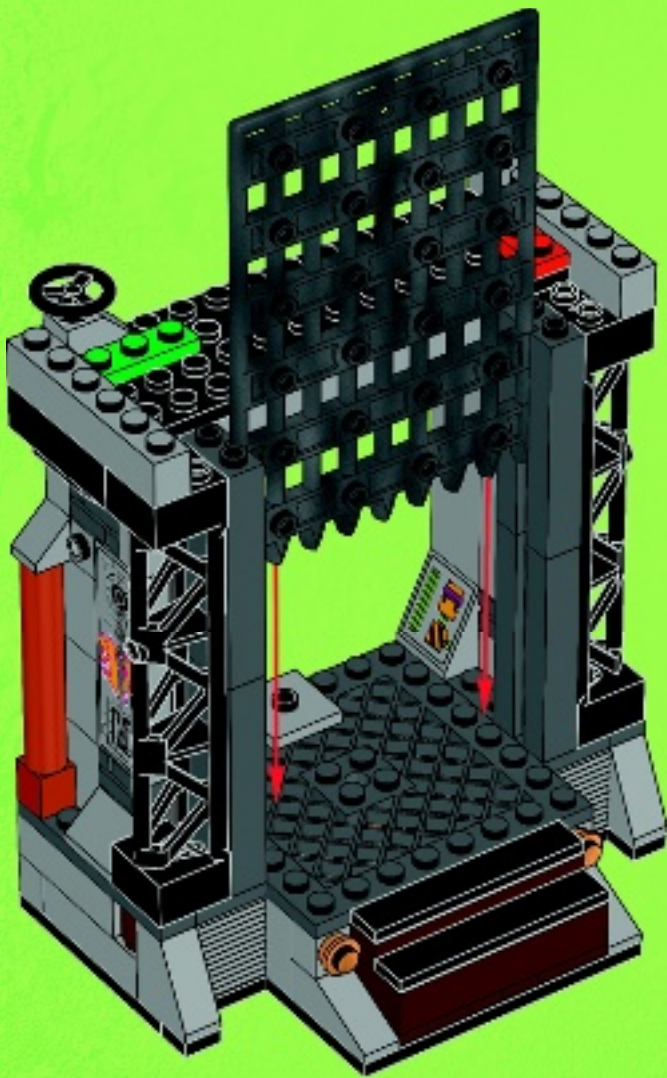

26

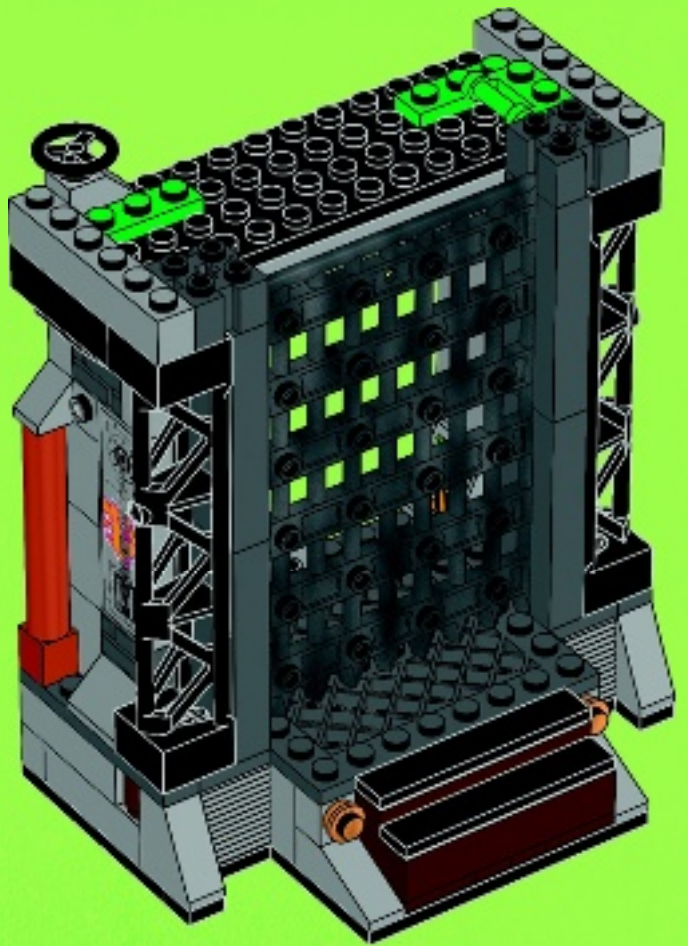

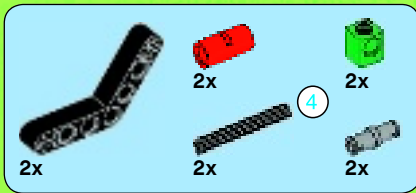

27

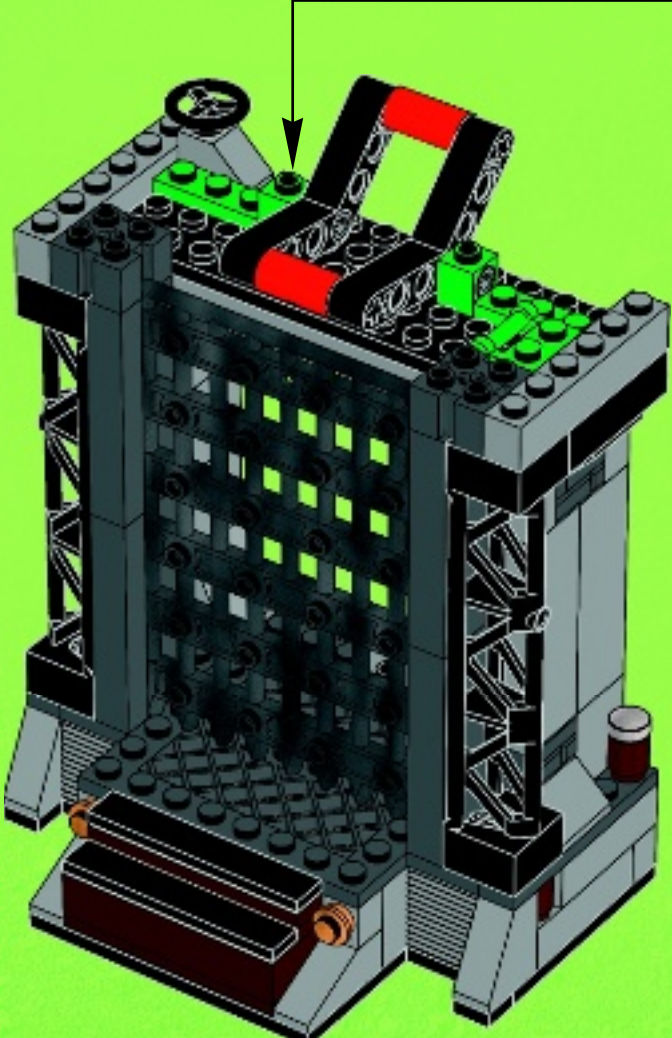
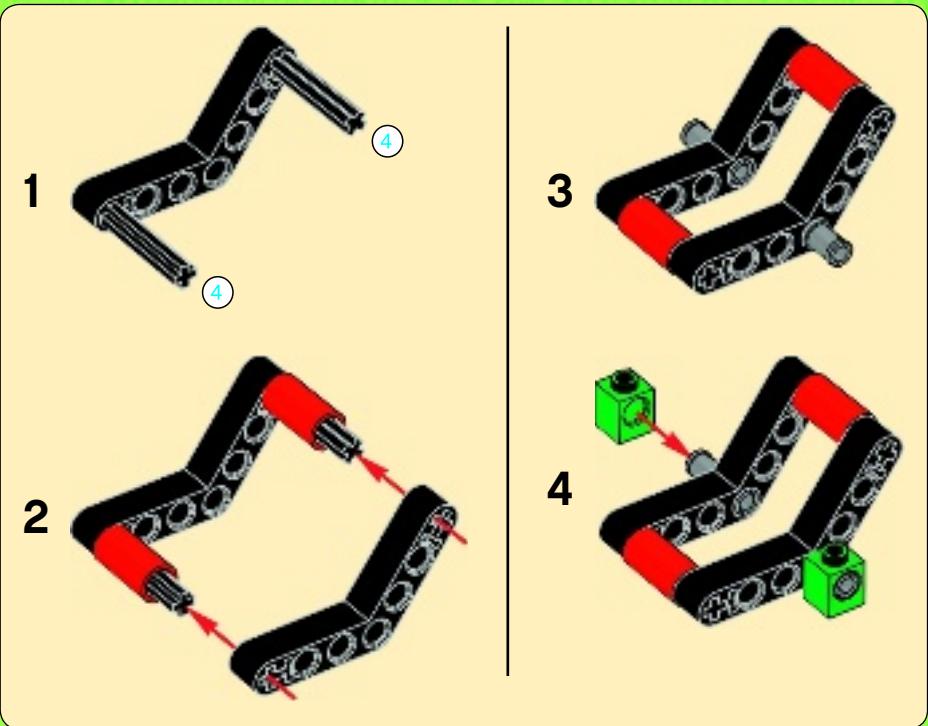

2x

2x

28

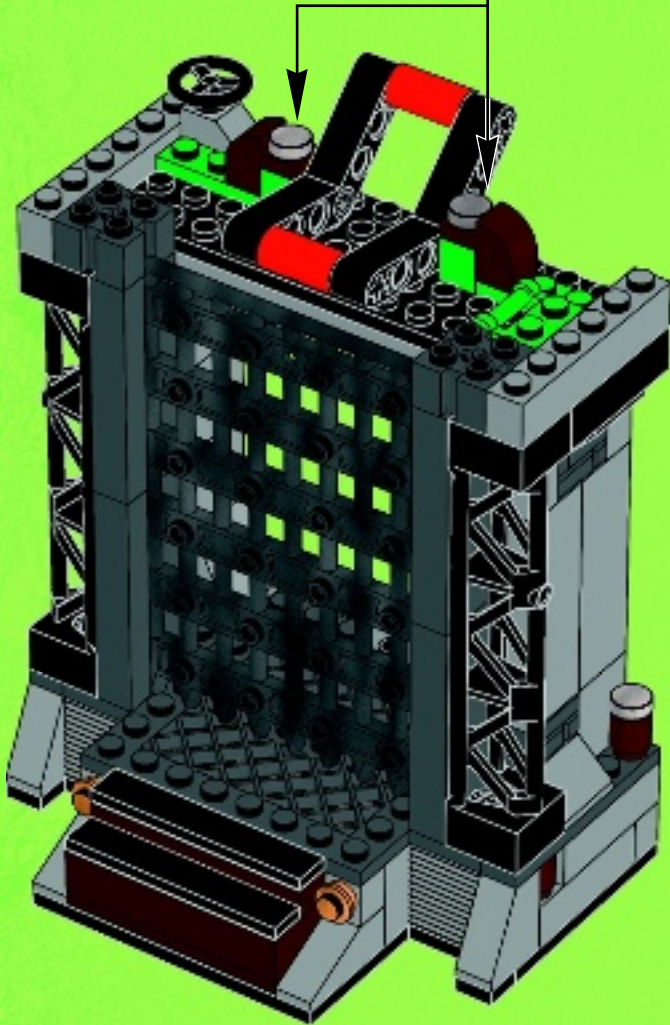

1x

2x

2x

29

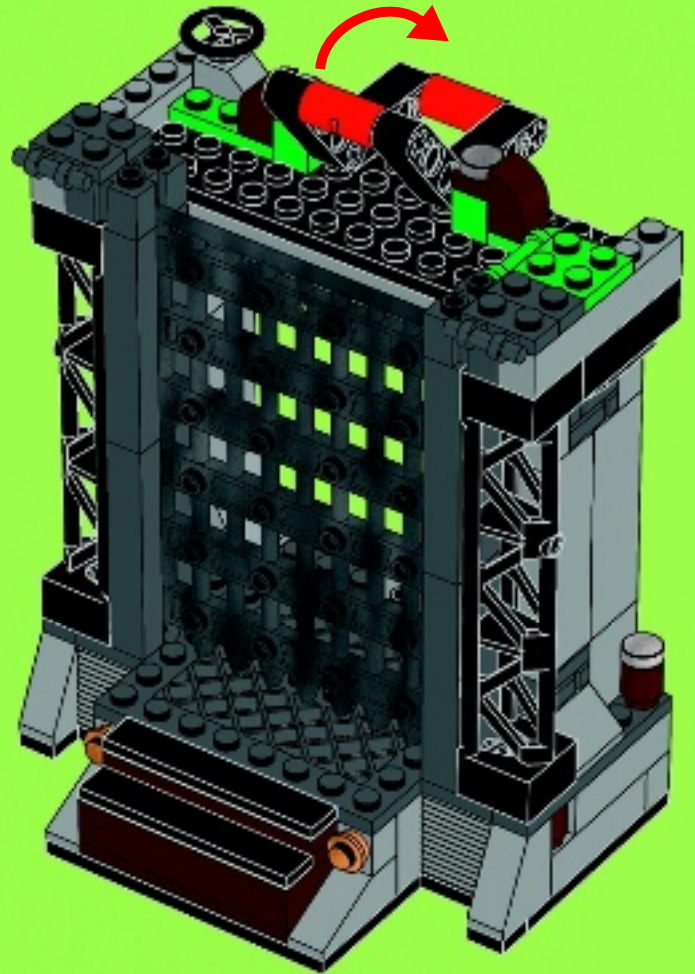



2x



2x

30

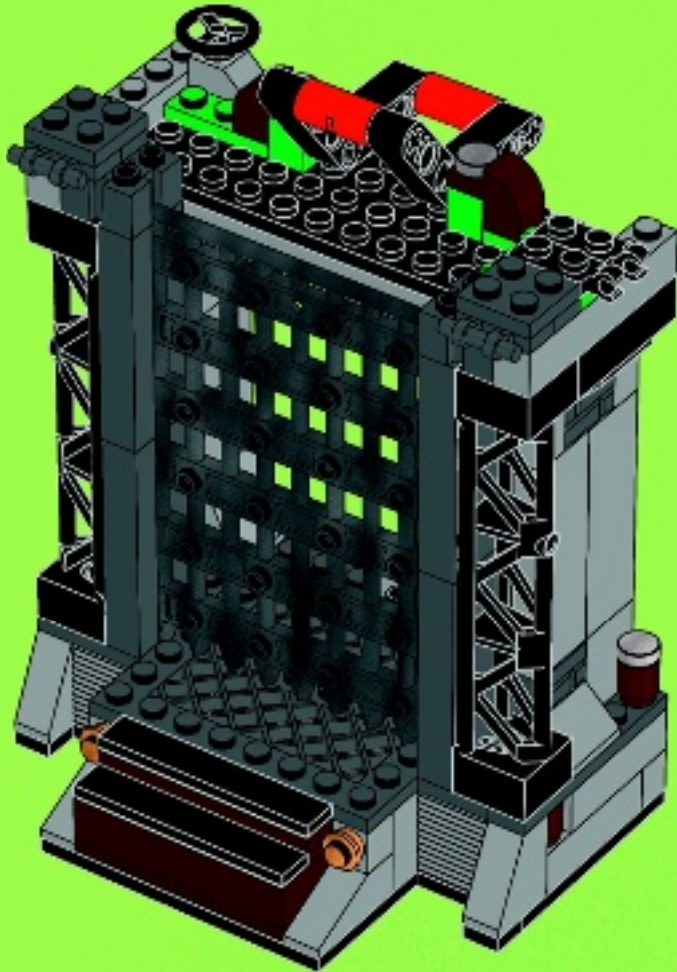

1x



2x



4x



2x

31

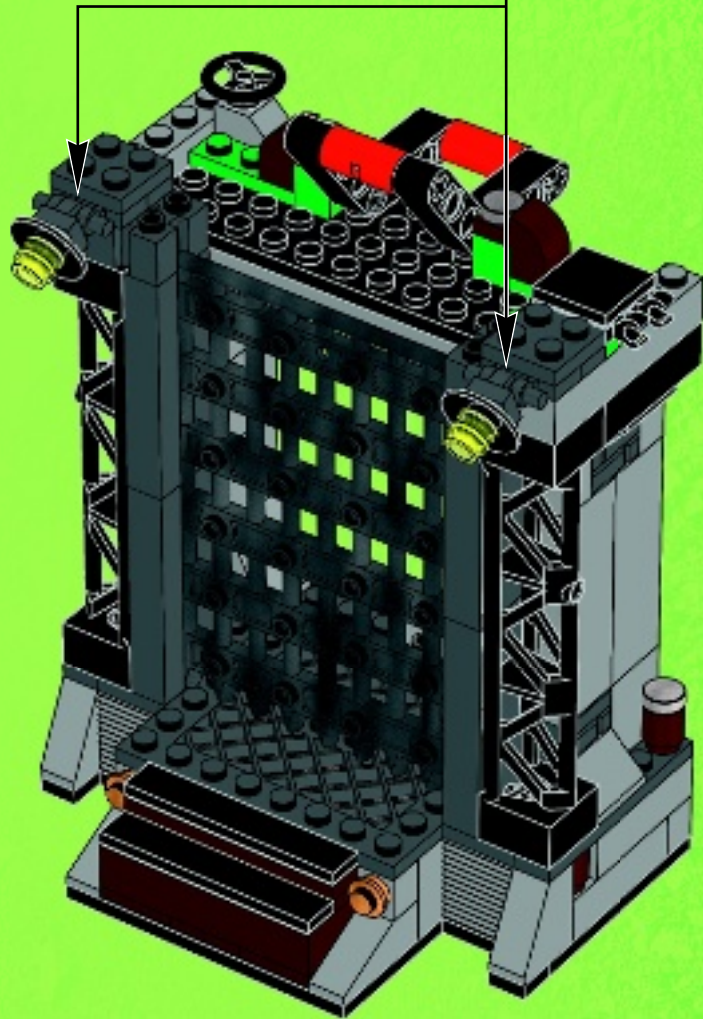
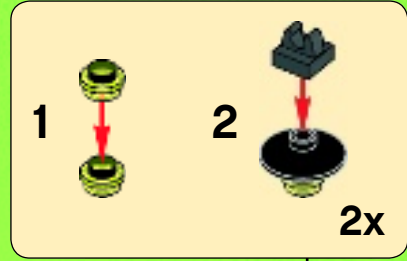



2x



2x

32

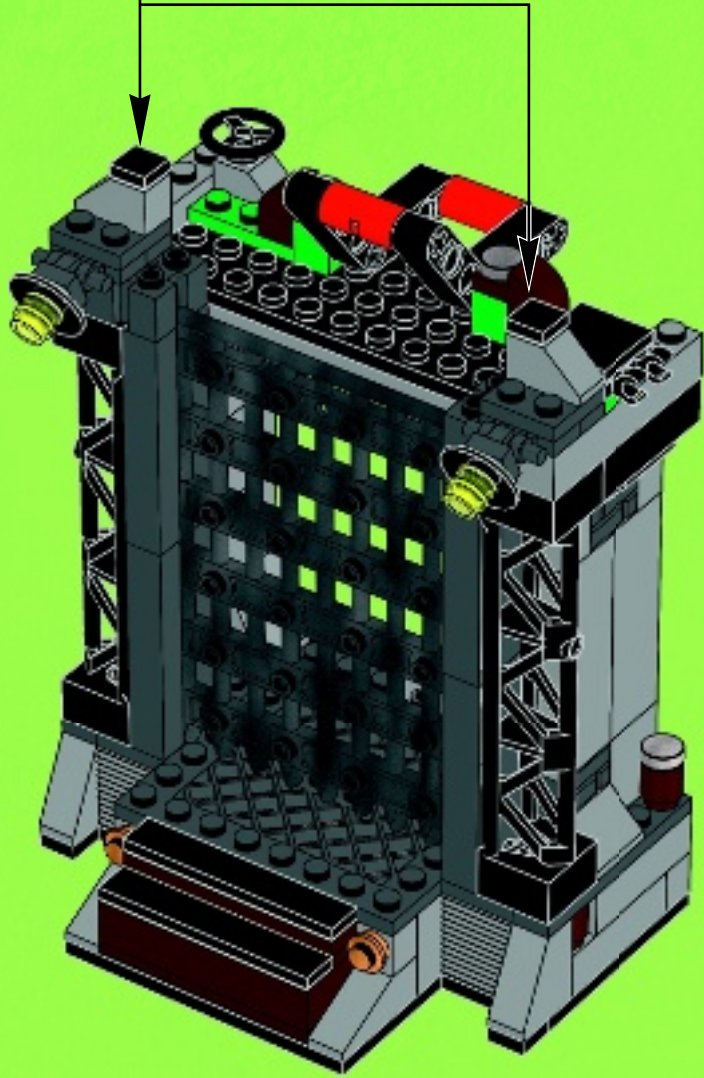
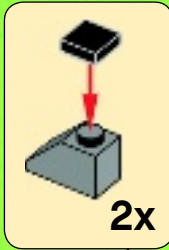

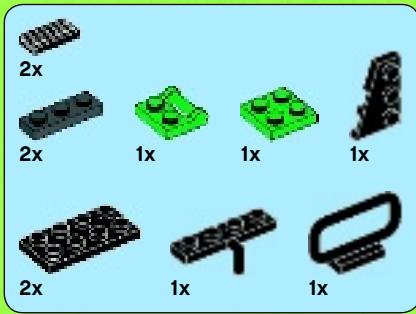

33

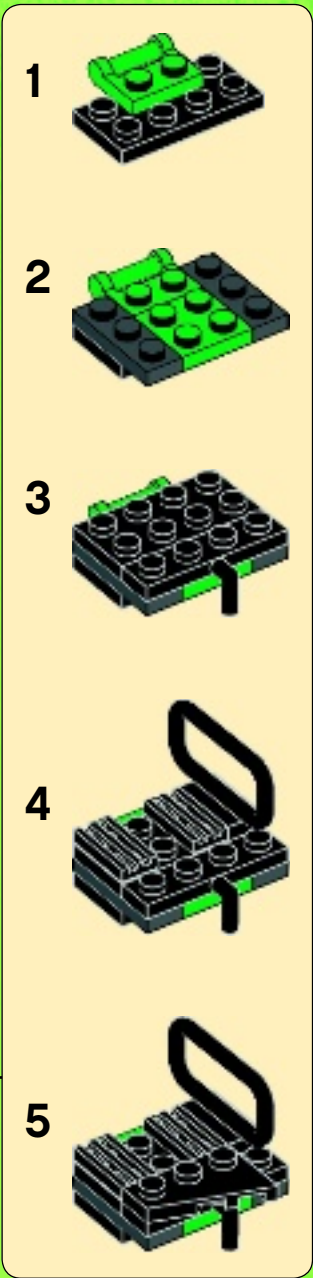
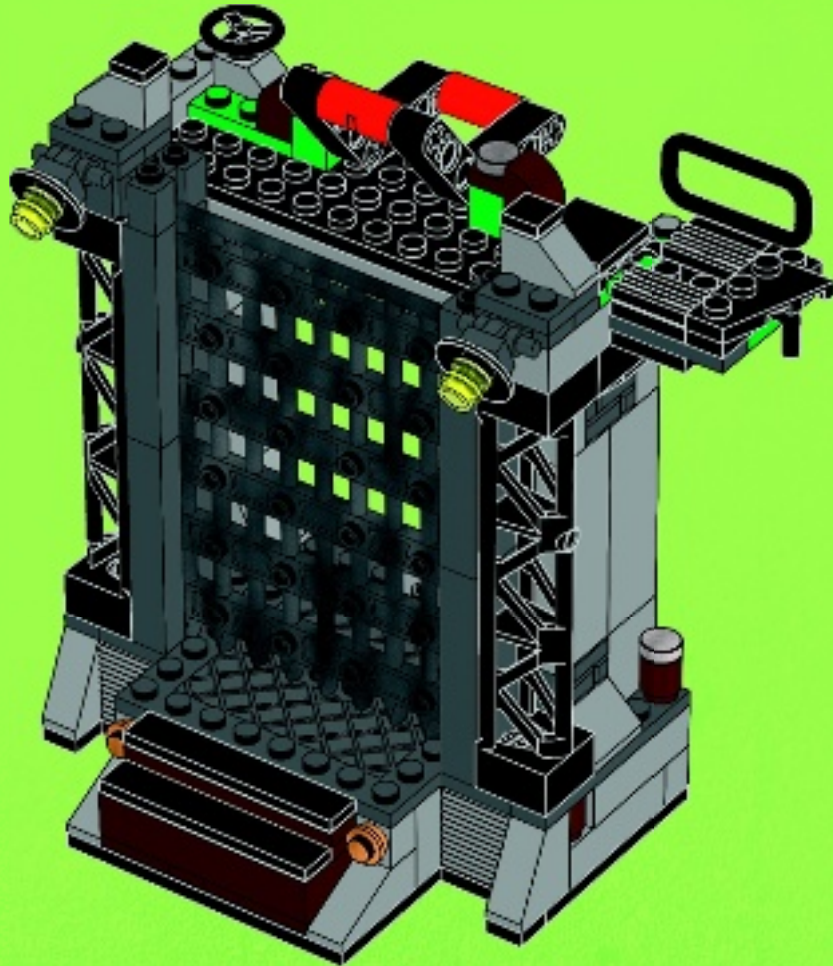

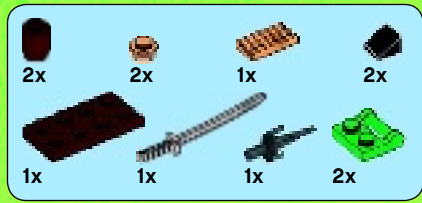

34

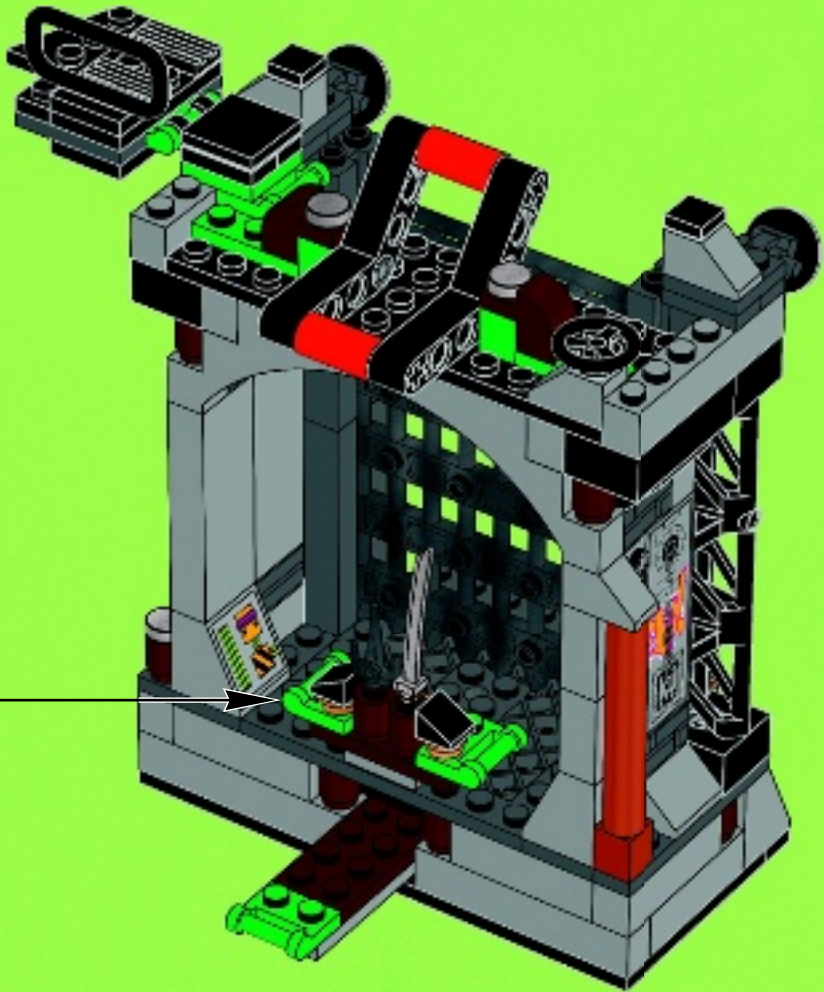
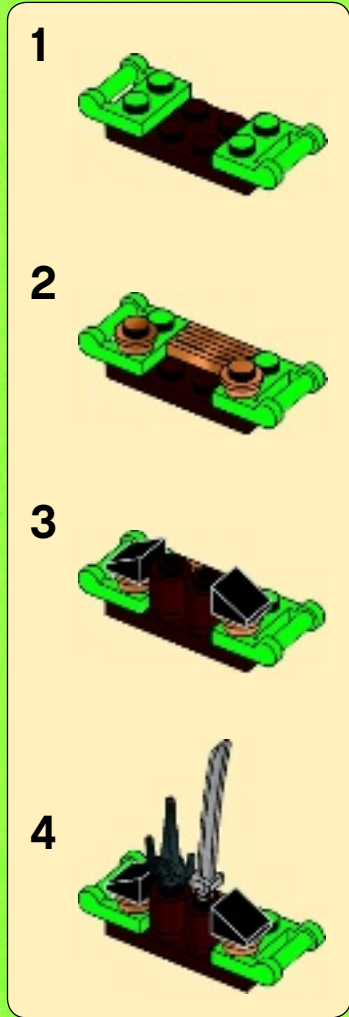

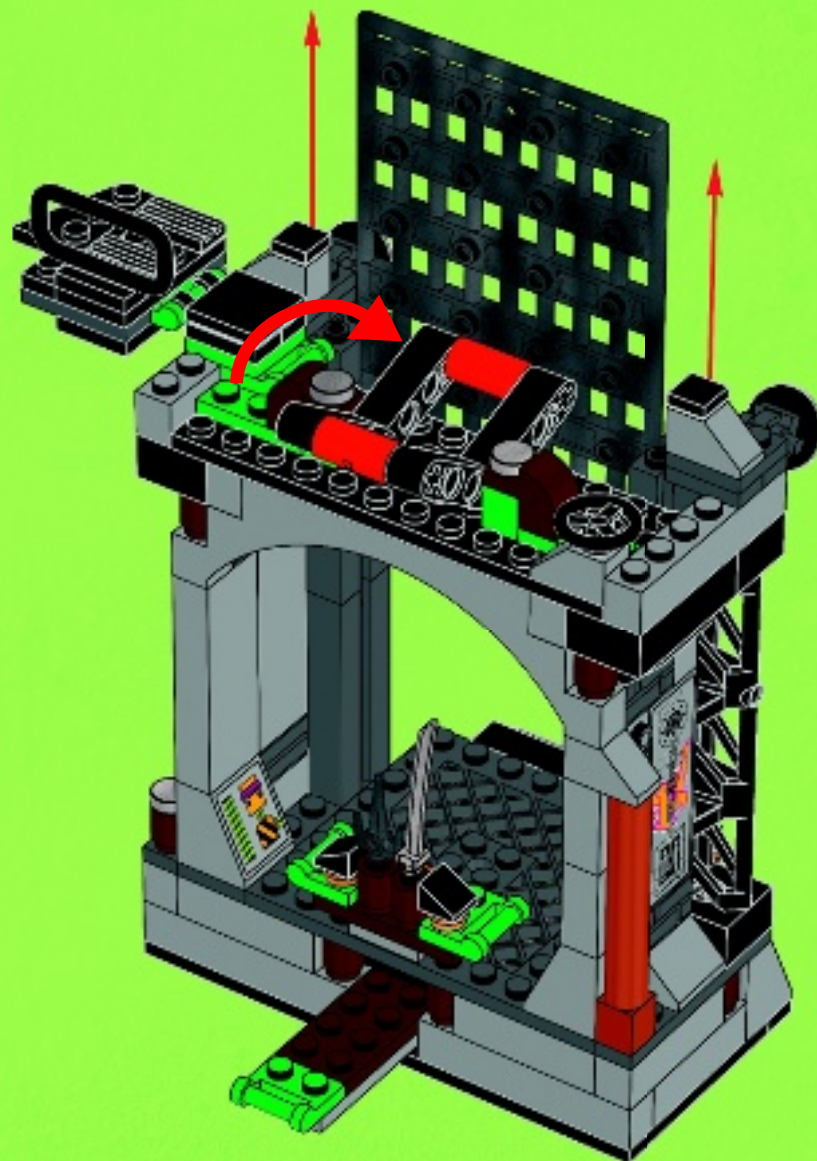

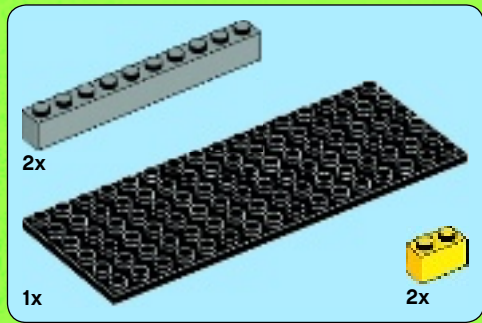
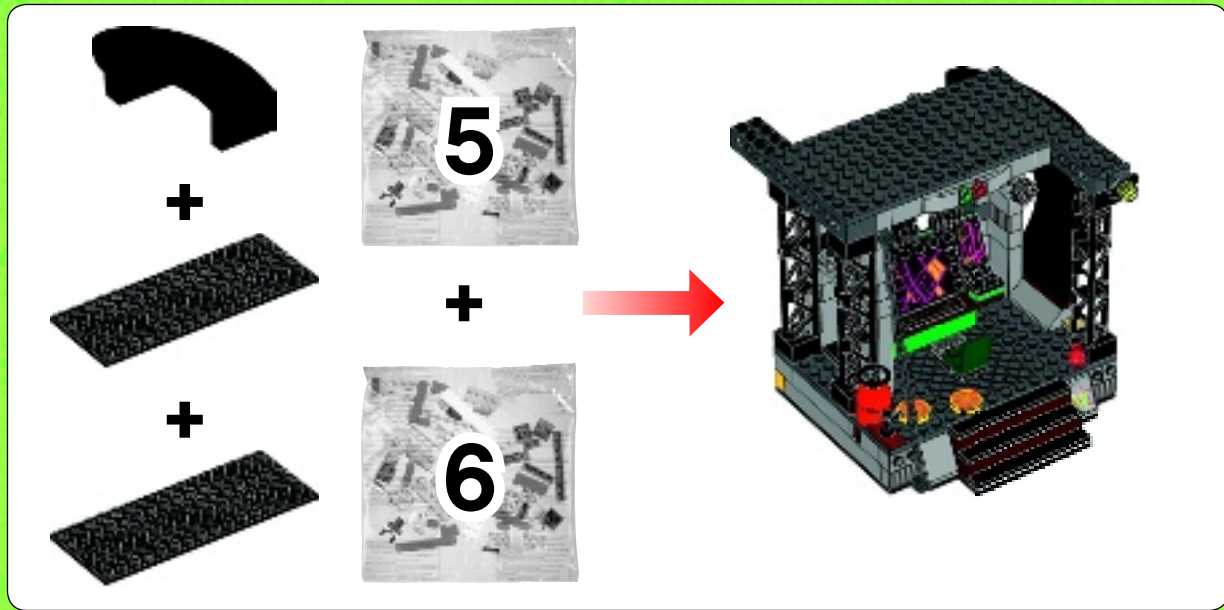

1

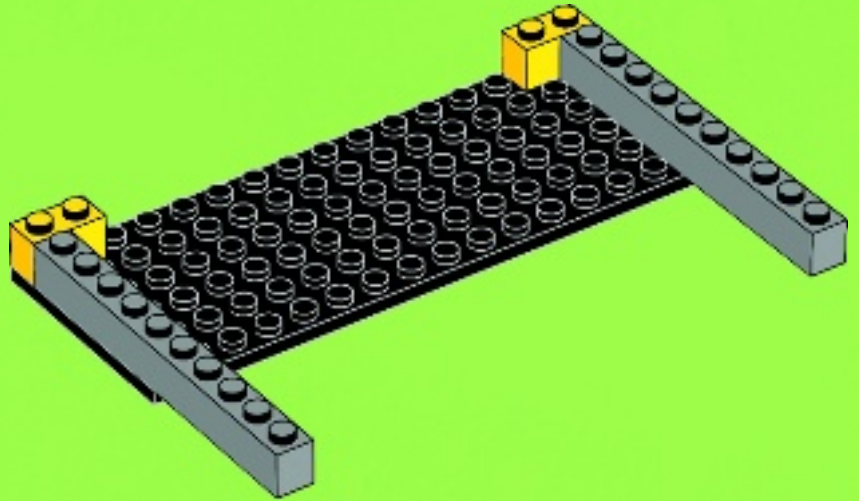

2

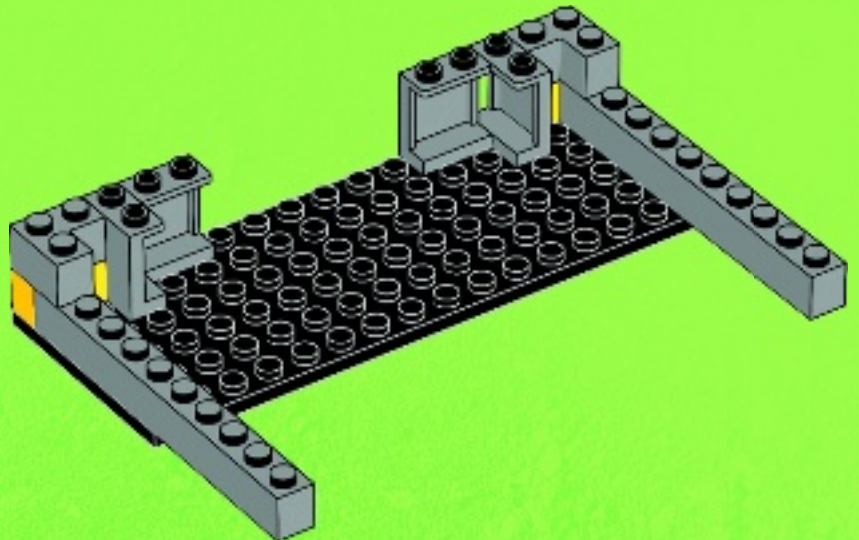

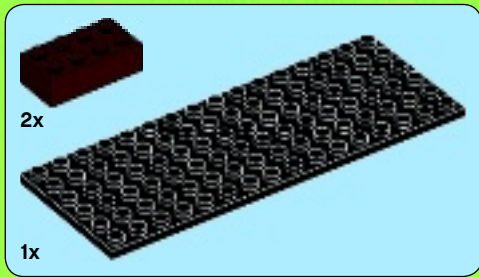

3

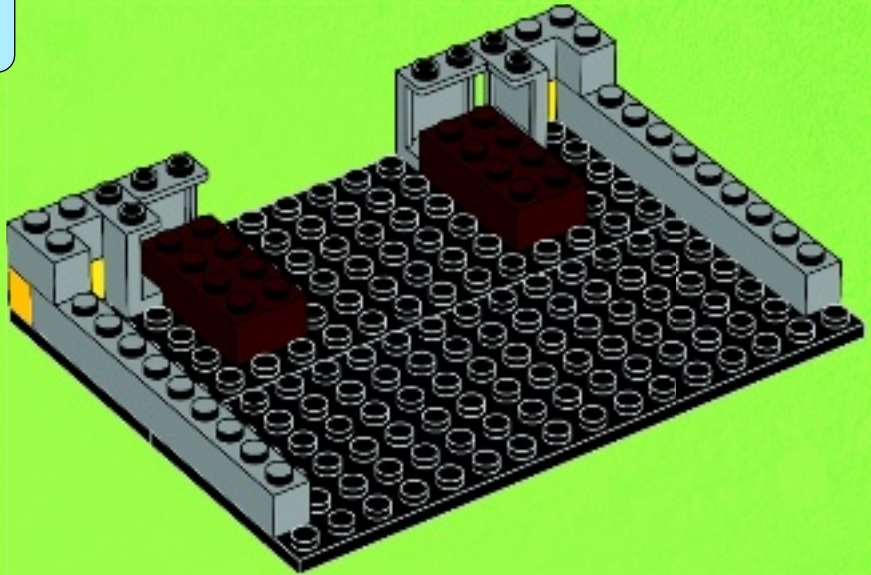

4

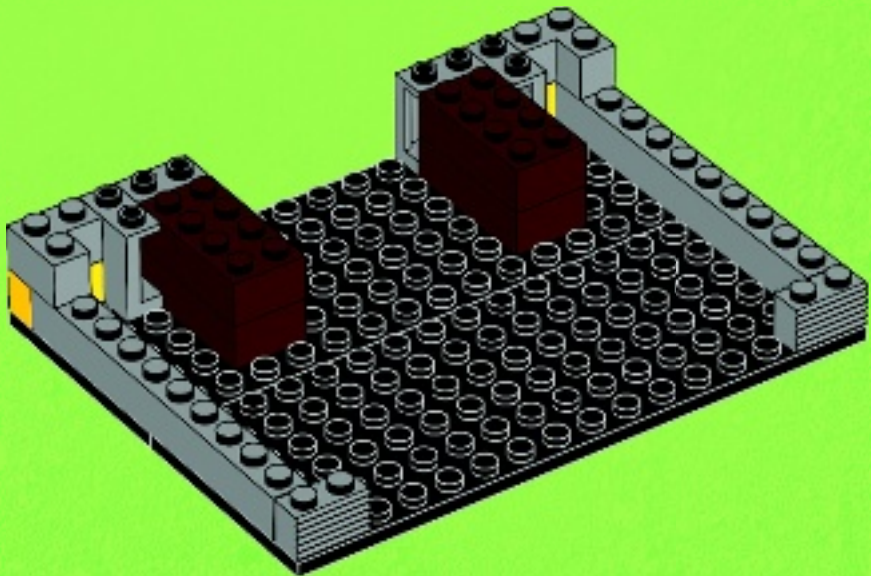



5

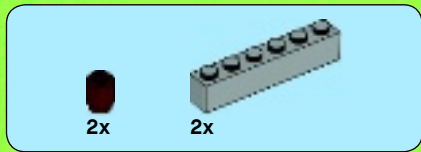
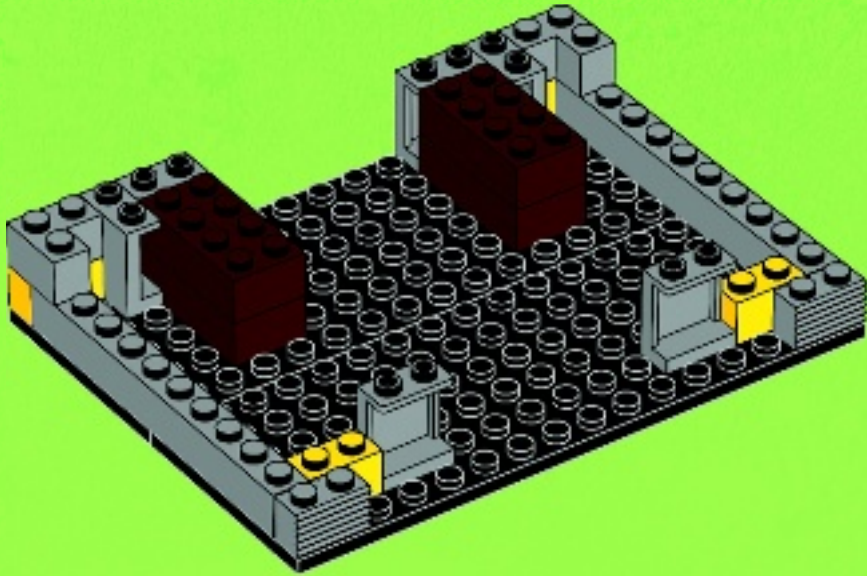

6

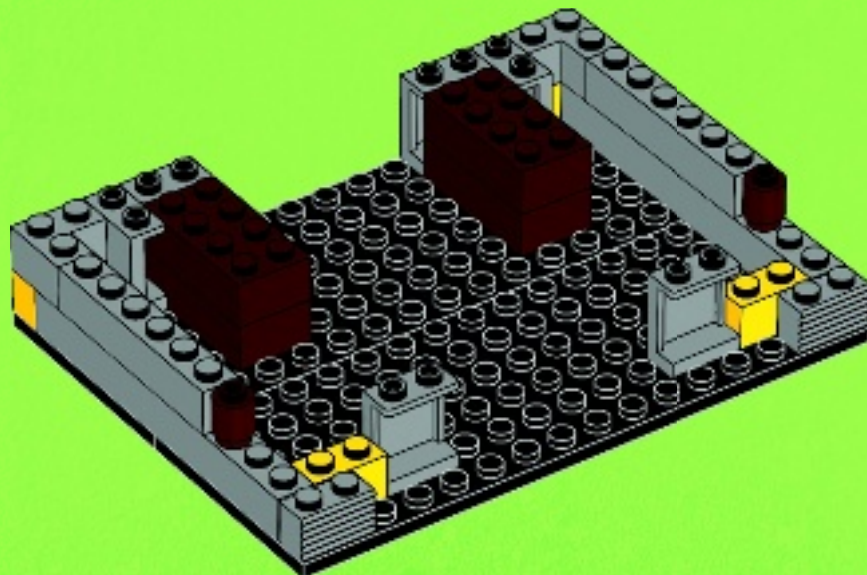



2x



4x

7

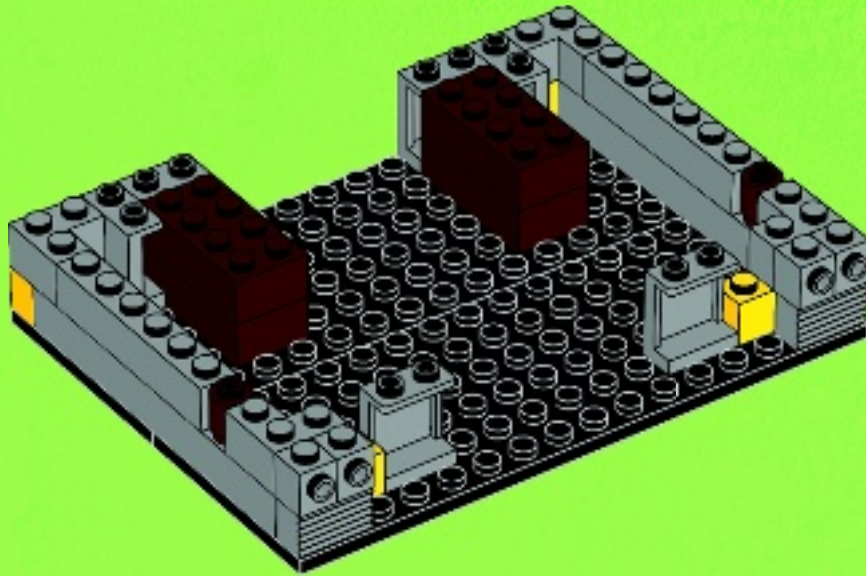

1x



2x

8

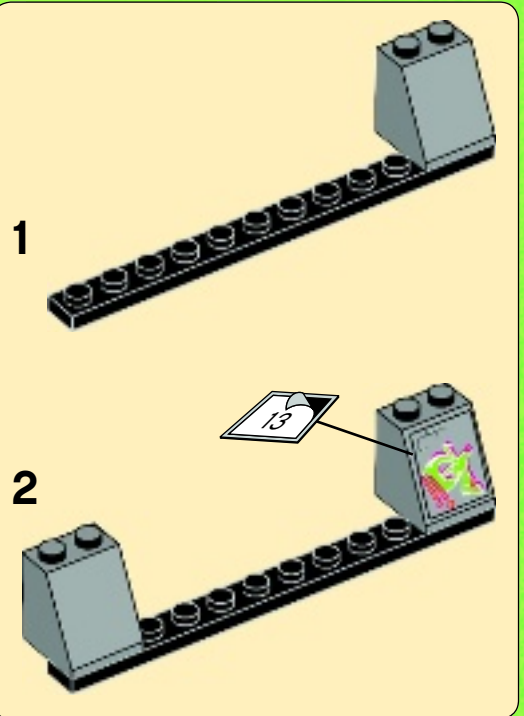
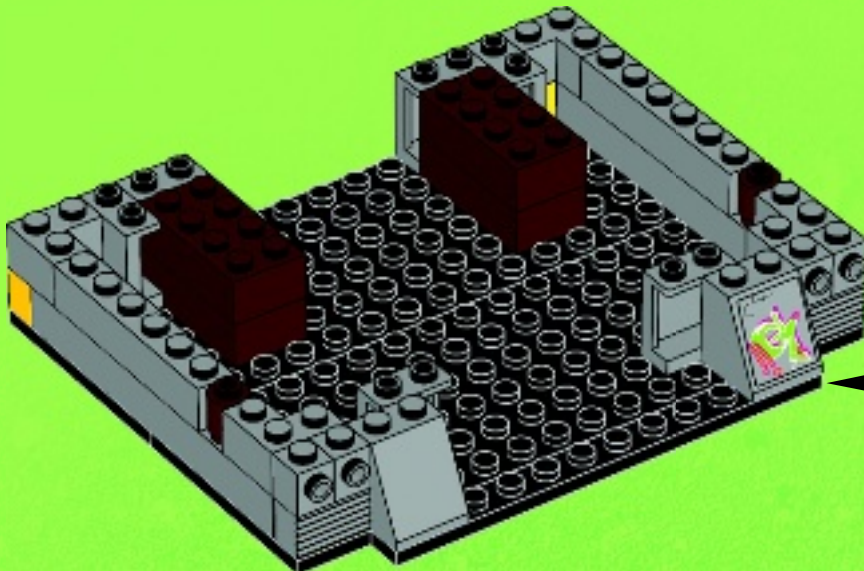

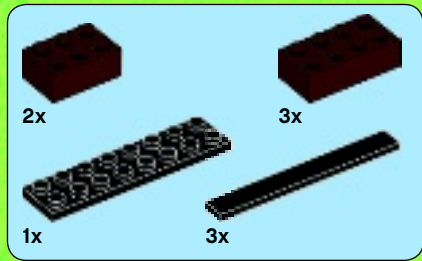

9

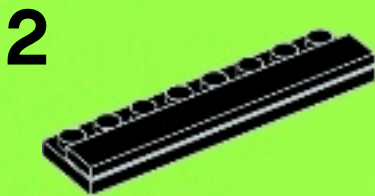

3

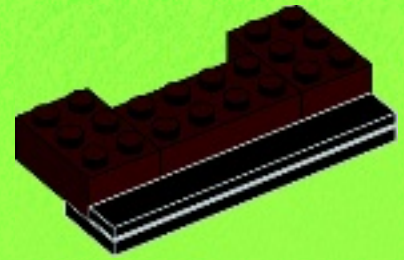

4

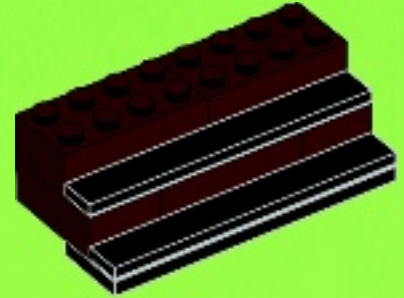

5

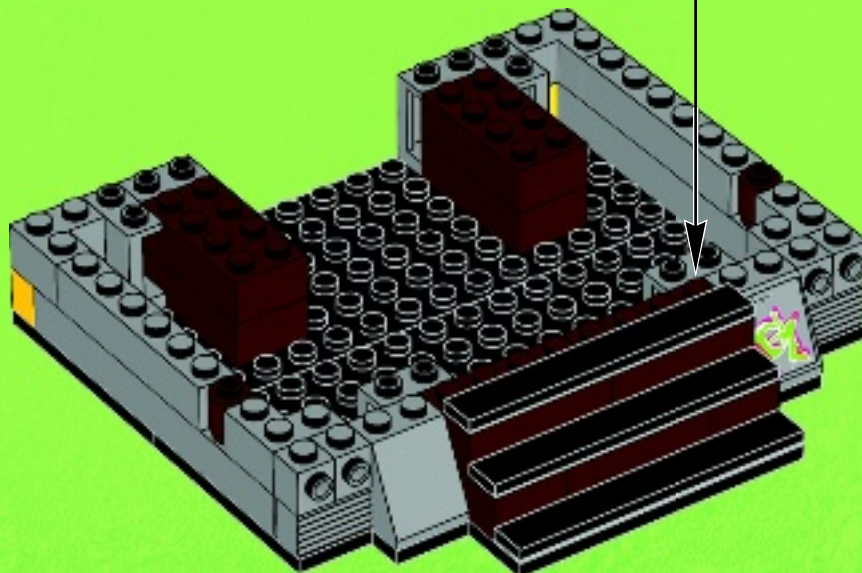
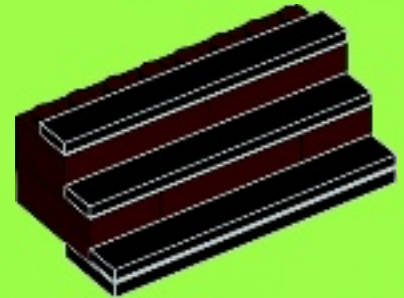

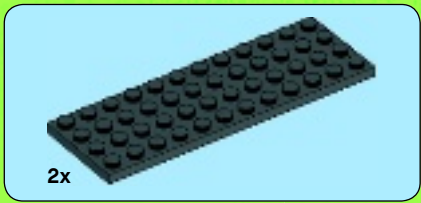

10

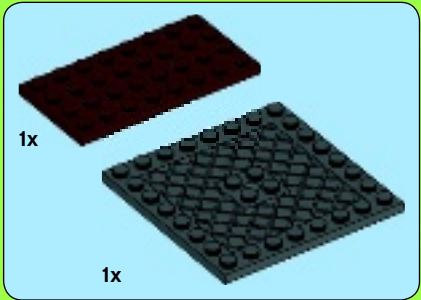
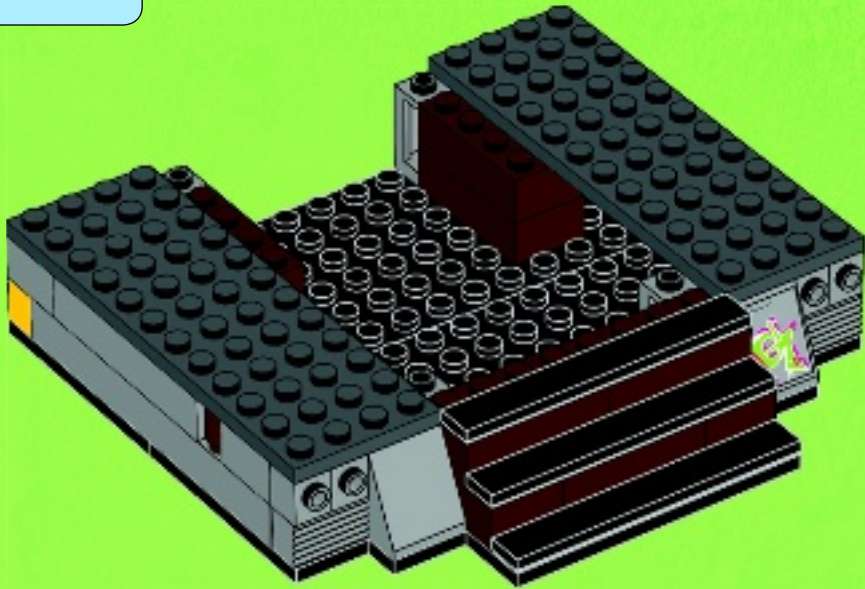

11

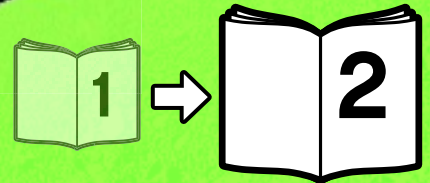
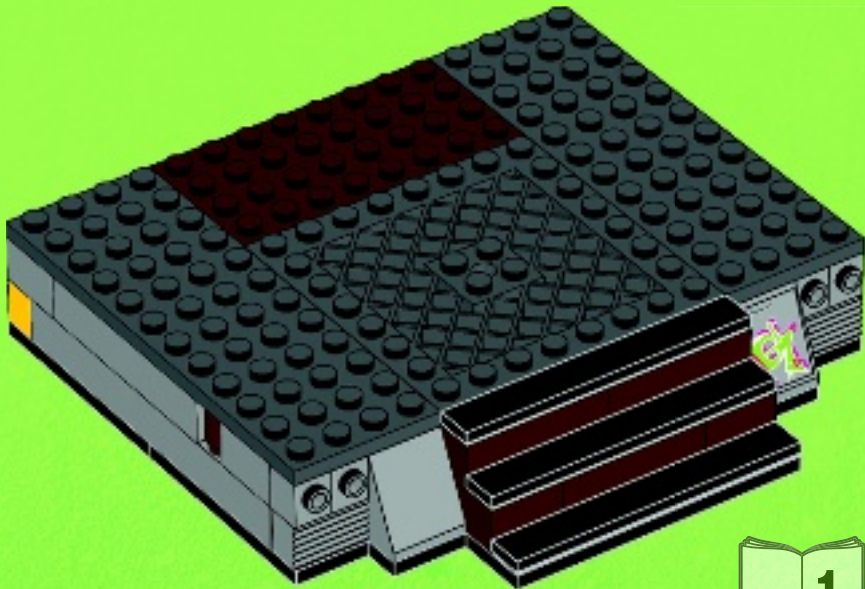



WIN!

Go to LEGO.com/productfeedback to fill out a survey for a chance to win a cool LEGO® Product.

No purchase necessary.

Open to all residents where not prohibited.



LEGO.com/productfeedback

GEWINNE!

Nimm an der Umfrage auf LEGO.com/productfeedback teil und hab die Chance ein cooles LEGO® Produkt zu gewinnen!

Die Teilnahme am Gewinnspiel führt zu keinerlei Kaufverpflichtungen. Teilnahme in allen nicht ausgeschlossenen Ländern möglich.

WIN!

Ga naar LEGO.com/productfeedback, vul een enquêteformulier in en maak kans op een cool LEGO® product.

Geen aankoopverplichting.
Ledereen mag deelnemen, uitgezonderd ingezetenden van landen waar een enquêteverbod geldt.

GAGNE!

Visite LEGO.com/productfeedback pour répondre à un questionnaire et avoir une chance de gagner un produit LEGO® très cool!

Aucune obligation d'achat.
Ouvert à tous les résidents des pays autorisés.

当てよう!

LEGO.com/productfeedbackにアクセスして、アンケートにご記入ください。当選者にはレゴ®製品を差し上げます。

お買い上げの必要はありません。
禁止されていない限り、すべての皆様にご利用いただけます。



LEGO.com